

FINAL
KNKT.14.12.29.04

KOMITE NASIONAL KESELAMATAN TRANSPORTASI

Aircraft Accident Investigation Report

**PT. Indonesia Air Asia
Airbus A320-216; PK-AXC
Karimata Strait
Coordinate 3°37'19"S - 109°42'41"E
Republic of Indonesia
28 December 2014**



**KOMITE NASIONAL KESELAMATAN TRANSPORTASI
REPUBLIC OF INDONESIA
2015**



This final report was produced by the Komite Nasional Keselamatan Transportasi (KNKT), 3rd Floor Ministry of Transportation, Jalan Medan Merdeka Timur No. 5 Jakarta 10110, Indonesia.

The report is based upon the investigation carried out by the KNKT in accordance with Annex 13 to the Convention on International Civil Aviation, the Indonesian Aviation Act (UU No. 1/2009) and Government Regulation (PP No. 62/2013).

Readers are advised that the KNKT investigates for the sole purpose of enhancing aviation safety. Consequently, the KNKT reports are confined to matters of safety significance and may be misleading if used for any other purpose.

As the KNKT believes that safety information is of greatest value if it is passed on for the use of others, readers are encouraged to copy or reprint for further distribution, acknowledging the KNKT as the source.

When the KNKT makes recommendations as a result of its investigations or research, safety is its primary consideration.

However, the KNKT fully recognizes that the implementation of recommendations arising from its investigations will in some cases incur a cost to the industry.

States participating in KNKT investigation should note that the information in KNKT reports and recommendations is provided to promote aviation safety. In no case is it intended to imply blame or liability.

TABLE OF CONTENTS

TABLE OF CONTENTS	1
TABLE OF FIGURES.....	5
ABBREVIATIONS AND DEFINITIONS.....	6
INTRODUCTION.....	13
1 FACTUAL INFORMATION	14
1.1 History of Flight.....	14
1.2 Injuries to Persons.....	17
1.3 Damage to Aircraft.....	18
1.4 Other Damage	19
1.5 Personnel Information.....	19
1.5.1 Pilot in Command	19
1.5.2 The PIC background and flight experience	20
1.5.3 The PIC exposure to Rudder Travel Limiter problem.....	21
1.5.4 Second in Command.....	22
1.5.5 The SIC flight experience background	22
1.6 Aircraft Information.....	23
1.6.1 General.....	23
1.6.2 Engines	24
1.6.3 Maintenance History related to RTLU	24
1.6.3.1 Maintenance Report 1 (MR1) and Maintenance Report 2 (MR2) ...	24
1.6.3.2 Defect Handling in Line Maintenance using Post Flight Report (PFR).....	25
1.6.3.3 Summary of PK-AXC 1 Year Maintenance Report.....	26
1.6.3.4 Reliability Report Issued on November 2014.....	27
1.6.3.5 Last Three Day Records.....	27
1.6.3.6 FAC Shop Finding Report	28
1.6.3.7 Summary	28
1.6.4 Weight and Balance (Load and Trim Sheet)	29
1.6.5 Aircraft Systems	29
1.6.5.1 Flight Control System	29
1.6.5.2 Control Law	31
1.6.5.3 Lateral Consoles.....	33

1.6.5.4	Characteristic of pitch and lateral	34
1.6.5.5	Rudder Travel Limitation.....	36
1.6.5.6	Flight Augmentation Computer (FAC).....	37
1.6.5.7	The location of FAC 1-2 Push Button and Circuit Breakers	38
1.6.5.8	Display Management Switching Panel	39
1.6.5.9	Air Data System Schematic	39
1.6.5.10	ECAM control panel	40
1.7	Meteorological Information	42
1.8	Aids to Navigation	43
1.9	Communications	44
1.10	Aerodrome Information	44
1.11	Flight Recorders	44
1.11.1	Flight Data Recorder.....	44
1.11.2	Recorded system failure	52
1.11.3	Cockpit Voice Recorder	54
1.11.4	Selected significant events based on CVR and FDR.....	56
1.12	Wreckage and Impact Information	60
1.13	Medical and Pathological Information.....	63
1.14	Fire	63
1.15	Survival Aspects	63
1.16	Tests and Research.....	64
1.16.1	Flight Simulation	64
1.16.2	The RTLU examination	65
1.17	Organisation and Management Information	67
1.17.1	Summary of Management Interview	67
1.17.2	Summary of Maintenance Management Interview.....	67
1.17.3	Company Manuals	69
1.17.3.1	Company Operation Manual (COM)	69
1.17.3.2	FCOM - Normal Checklist.....	70
1.17.3.3	FCOM - Auto Flight Rudder Limiter System	71
1.17.3.4	Flight Crew Training Manual (FCTM)	72
1.17.3.5	FCTM - Abnormal Attitudes.....	78
1.17.3.6	FCTM - Side-stick and takeover Priority Button.....	79

1.17.3.7	OTM - Upset Training Syllabus.....	79
1.17.3.8	Standard Operating Procedures.....	80
1.17.3.9	SOP-Standard Call Outs.....	82
1.17.3.10	QRH - General.....	82
1.17.3.11	QRH - Stall Recovery.....	85
1.17.3.12	QRH - Tripped Circuit Breaker Re-Engagement	86
1.17.3.13	Company Maintenance Manual (CMM)	86
1.17.3.14	Engineering Procedure Manual	90
1.17.3.15	Reliability Manual	92
1.17.3.16	Troubleshooting Manual (TSM).....	94
1.17.4	Directorate General of Civil Aviation (DGCA)	94
1.18	Additional Information	95
1.18.1	Stall.....	95
1.18.2	Stall.....	98
1.18.3	Rudder deflection.....	99
1.18.7	Civil Aviation Safety Regulation (CASR) part 121	102
1.19	Useful or Effective Investigation Techniques.....	102
2	ANALYSIS	103
2.1	Un-commanded aircraft roll.....	103
2.2	Electrical interruption	104
2.3	RUD TRV LIM SYS Message Handling.....	106
2.4	Side stick inputs	107
2.4.1	First Aural Stall warning	108
2.4.2	Second Aural Stall Warning	109
2.5	Pilot recognition of stall.....	110
2.6	Crew Resource Management	112
2.7	Maintenance handling on aircraft system problem	114
2.7.1	The Line Maintenance	114
2.7.2	The Maintenance Organization.....	116
3	CONCLUSION	117
3.1	Findings.....	117
3.2	Contributing factors	121

4	SAFETY ACTION.....	123
4.1	Aircraft operator.....	123
5	SAFETY RECOMMENDATIONS.....	125
5.1	Aircraft Operator.....	125
5.2	Directorate General Civil Aviation.....	125
5.3	Aircraft Manufacturer.....	125
5.4	United States Federal Aviation Administration and European Aviation Safety Agency.....	125
6	APPENDICES.....	126
6.1	Air Operator Safety Action.....	127
6.2	Operation Training Manual: upset recovery training.....	155
6.3	Safety First, Airbus Safety Magazines January 2011.....	156
6.4	Upset Recovery Industry Team.....	162
6.5	Airbus Upset Recovery Training.....	163
6.6	Airbus A320 Type Qualification Training-Handling Phase FFS 4.....	166
6.7	Summary of “PK-AXC Defect 1 Year” Report.....	171
6.8	PFR Summary.....	174
6.9	Troubleshooting Manual (TSM) Task 22-61-00-810-803-A.....	177
6.10	Reliability Report November 2014.....	180
6.11	Startle Reflex.....	180
6.12	Ebbinghaus Curve and Review.....	182
6.13	Accredited Representatives Comments.....	184
7	REFERENCES.....	210

TABLE OF FIGURES

Figure 1: Archive photo of the aircraft	14
Figure 2: The aircraft flight track.....	17
Figure 4: One section of passenger seats	18
Figure 5: Centre fuselage section including the wings and main landing gears	19
Figure 6: Typical Printed Post Flight Report (PFR)	25
Figure 7: Numbers of the RTLU Occurrences in 2014.....	27
Figure 9: The overhead panel shows the location of FAC 1 CBs, FAC 1 and 2 push buttons	38
Figure 10: The location of FAC 2 CB, behind the First Officer’s seat (red line)	38
Figure 11: Switching panel on pedestal	39
Figure 12: The Pitot Static Configuration.....	39
Figure 13: line probes schematic	40
Figure 14: ECAM control panel	40
Figure 16: The cloud height (in meter) view along the airways of M635	42
Figure 17: Automatic Dependent Surveillance – Broadcast (ADS-B) data superimposed to Google earth	43
Figure 18: ADS-B data	44
Figure 20: RTLU problems and pilot actions	47
Figure 21: FDR parameters after the fifth Master Caution	48
Figure 23: Thrust levers and side-sticks movement.....	51
Figure 24: The FDR parameters of FAC fault followed by CB reset on the ground at 25 December 2014	52
Figure 26: The first aural Stall warning activated.....	57
Figure 28: Aircraft in upsetsituation	59
Figure 29: Attitude recovered	59
Figure 30: Wreckage Diagram superimposed on Google Map.....	61
Figure 32: Pictures of identified parts and its original position	62
Figure 33: The page 1 and 2 of the ECAM messages after CBs of FAC 1 and 2 being reset	64
Figure 34: The ECAM messages after RTLU 1 and 2 fault	65
Figure 36: Reducing thrust leads to a decrease in AOA	96

ABBREVIATIONS AND DEFINITIONS

AAA	:	Air Asia Academy
AAIB (Singapore)	:	Air Accident Investigation Bureau of Singapore
AAIB (UK)	:	Air Accidents Investigation Branch of United Kingdom
AD	:	Airworthiness Directive
ADIRS	:	Air Data and Inertial Reference System
ADS-B	:	Automatic Dependent Surveillance-Broadcast
AFM	:	Aircraft Flight Manual
Airplane Upset:		An airplane in flight unintentionally exceeding the parameters normally experienced in line operations or training: <ul style="list-style-type: none">• Pitch attitude greater than 25 degree, nose up.• Pitch attitude greater than 10 degree, nose down.• Bank angle greater than 45 degree.• Within the above parameters, but flying at airspeeds inappropriate for the conditions.
ALERFA	:	Phase activates the Search & Rescue and State Security Forces and all ATC units along the whole route are contacted
ALT	:	Altitude
AMM	:	Aircraft Maintenance Manual Approved Maintenance Organization
AMOS	:	Airlines Maintenance and Operational System
AOA	:	Angle of attack is the angle between the oncoming air or relative wind, and some reference line on the airplane or wing.
A/P	:	Autopilot
AOC	:	Air Operator Certificate a commercial transport license for airlines
ARAIB	:	Aviation and Rail Accident Investigation Board
ATC	:	Air Traffic Control
A/THR	:	Auto thrust
ATM	:	Air Traffic Management
ATPL	:	Air Transport Pilot License is the highest level of aircraft pilot licence
ATS	:	Air Traffic Service
ATSB	:	Australian Transport Safety Bureau
BEA	:	Bureau d'Enquêtes et d'Analyses
BMKG	:	Badan Meterologi Klimatologi dan Geofisika (Metrological Climatology and Geophysical Agency)

BASARNAS	:	<i>Badan Search and Rescue Nasional</i> (National Search and rescue Agency)
BSCU	:	Braking Steering Control Unit
°C	:	Degrees Celsius
CAA China	:	Civil Aviation Administration of China
CAS	:	Calibrated Airspeed
CB	:	Circuit breaker
CB	:	Cumulonimbus cloud
CFDS	:	Centralized Fault Display System
CG	:	Centre of gravity
Cl	:	Lift Coefficient
CMM	:	Company Maintenance Manual
COM	:	Company Operation Manual
CRM	:	Crew resources Management
CVR	:	Cockpit Voice Recorder
daN	:	Deka Newton
DGCA	:	Directorate General of Civil Aviation of Indonesia
DMC	:	Display Management Computer
DNA	:	Deoxyribonucleic Acid
DOA	:	Design Organization Approval
DVI	:	Disaster Victim Identification
EASA	:	European Aviation Safety Agency
EC	:	European Community
ECB	:	Electronic Control Box (APU)
ECAM	:	Electronic Centralized Aircraft Monitoring
EI	:	Engineering Instruction
EIS	:	Electronic Instruments System
EIU	:	Engine Interface Unit
EFIS	:	Electronic Flight Instruments System
EGT	:	Exhaust Gas Temperature
ELAC	:	Elevator Aileron Computer
EPM	:	Engineering Procedure Manual
ETOPS	:	Extended Twin Engine Operations
E/WD	:	Engine Warning Display

FAA	:	Federal Aviation Administration
FAC	:	Flight Augmentation Computer
FCDC	:	Flight Control Data Concentrators
FCOM	:	Flight Crew Operation Manual
FCTM	:	Flight Crew Training manual
FCU	:	Flight Control Unit
FD	:	Flight Director
FDR	:	Flight Data Recorder
FDU	:	Fire Detection Unit
FFS	:	Full Flight Simulator
FL	:	Flight Level
FMGS	:	Flight Management and Guidance System.
ft	:	Feet a unit of length
FWC	:	Flight Warning Computer
GW/CG	:	Gross Weight/Centre of Gravity
IAA	:	Indonesia Air Asia
IC	:	Inspection Card
ICAO	:	International Civil Aviation Organization
INAFIS	:	Indonesia Automatic Fingerprint Identification System
INCERFA	:	It is a situation in which there is uncertainty as to the safety of an aircraft and its occupants.
In Hg	:	Inch Hydrargyrum
ISIS	:	Integrated Standby Instrument System
Kg	:	Kilogram (s)
Km	:	Kilo meter (s)
KNKT	:	Komite Nasional Keselamatan Transportasi
Kts	:	Knots (Nm/hours)
LFUS	:	Line Flying Under-Supervision
lbs	:	Libs (pound)
LT	:	Local time
MAA	:	Malaysia Air Asia
MAC	:	Mean Aerodynamic Chord.
mbs	:	Millibars

MC	: Master Cautions
MCDU	: Multipurpose Control and Display Unit
MEL	: Minimum Equipment List.
MHz	: Mega Hertz is the unit of frequency in the International System of Units(SI) and is defined as one cycle per second
mm	: Millimetre(s) is a unit of length in the metric system
MMO	: Maximum Operating Mach
MOC	: Maintenance Operation Centre
MOM	: Maintenance Operation Manager
MOT	: Ministry of Transport (Malaysia)
MPA	: Marine Port Authority (Singapore)
N1	: Rotation speed of low pressure compressor (%).
N2	: Rotation speed of high pressure compressor (%)
ND	: Navigation Display
Nm	: Nautical mile(s)
NOTAM	: Notice to Airman
NTC	: Notice to crew
OEB	Operation Engineering Bulletin
OR	: Occurrence Report
PF	: Pilot Flying
PFD	: Primary flight display
PFR	: Post Flight Report is an automatic reporting system shows on the Centralized Fault Display System (CFDS) consist of ECAM message which contains any ECAM Warning related with system malfunction during the flight and Failure Message which states the failure component. The PFR message can be printed after completion of a flight.
PIC	: Pilot in Command
PM	: Pilot Monitoring
PNF	: Pilot Non flying
P/N	: Part Number
PSU	: Passenger Services Unit
QNH	: Height above mean sea level based on local station pressure
QRH	: Quick Reference Handbook
RTLU	: Rudder Travel Limiter Unit

RTLACT	:	Rudder Travel Actuator
RVSM	:	Reduced Vertical Separation Minima
SB	:	Service bulletin
SEC	:	Spoilers Elevator Computer
S/N	:	Serial Number is a unique code assigned to uniquely identify an item
SFCC	:	Slat/Flap Control Computer
SIC	:	Second in Command
Stall	:	An airplane is stalled when the angle of attack is beyond the stalling angle. A stall is characterized by any of, or a combination of, the following: <ul style="list-style-type: none"> a. Buffeting, which could be heavy at times, b. A lack of pitch authority, c. A lack of roll control, d. Inability to arrest descent rate.
STPI	:	<i>Sekolah Tinggi Penerbangan Indonesia</i> (Indonesia Civil Aviation Institute)
SW	:	Stall Warning
TCAS	:	Traffic Collision Avoidance Systems
TE	:	Trailing Edge
TEM	:	Threat and Error Management
TFU	:	Technical Follow Up
THS	:	Trimmable Horizontal Stabilizer
TOGA	:	Takeoff Go Around
TQ	:	Type Qualification
TSM	:	Trouble Shooting Manual
ULB	:	Underwater Locator Beacon or underwater acoustic beacon is a device fitted to aviation flight recorders such as the Cockpit Voice Recorder and Flight Data Recorder.
UTC	:	Universal Time Coordinate
VLE	:	Maximum Landing Gear Extended Speed
VLS	:	Lowest Selectable Speed
VHF	:	Very High Frequency
VS	:	Vertical speed
WD	:	Windshear Detection
WQAR	:	Wireless Quick Access Recorder

YDF : Yaw Damper Fault
ZFW : Zero Fuel Weight

ABBREVIATION OF FDR PARAMETERS

Note 1 or 2 indicated respective position.

AILDA : Aileron Deflection Angle
AOA IRS3 : Angle of Attack data based on Inertia Reference System 3 source
AP : Auto Pilot
ATHR : Auto Thrust
CFAC : Captain (left) Flight Augmentation Computer
CPTMC : Captain (Left) Master Caution
FAC(1/2)F : Flight Augmentation Computer (1 or 2) Fault
FFAC : First Officer (right) Flight Augmentation Computer
FOMC : First Officer (right) Master Caution
HPFSOV : High Pressure Fuel Shut Off Valve
ISISALT : Altitude data taken from Integrated Standby Instrument System source
ISISCAS : Calibrated Airspeed data taken from Integrated Standby Instrument System source
N1A : N1 (engine rotation)
PITCH : Pitch angle
PDLAW : Pitch Direct Law
PNLAW : Pitch Normal Law
RDLAW : Rudder Direct Law
RNLAW : Rudder Normal Law
ROLL : Roll angle
RTLACT : Rudder Travel Actuator
RU DT : Rudder Travel
STALLW : stall warning
STKCINOP : Sidestick Captain Inoperative
STKFINOP : Sidestick First Officer Inoperative
STKPC : Sidestick Pitch Captain (left)

STKPF : Sidestick Pitch First Officer (right)
STKRC : Sidestick Roll Captain (Left)
STKRF : Sidestick Roll First Officer (right)
TLA : Thrust Lever Angle
TLU : Travel Limiter Unit
VERTG : Vertical G
VSPD : Vertical Speed
WSD : Windshear Detection
YDF : Yaw Damper Fault

INTRODUCTION

Synopsis

On 28 December 2014 an Airbus A320-216 aircraft registered as PK-AXC was cruising at 32,000 feet on a flight from Juanda Airport, Surabaya, Indonesia to Changi Airport, Singapore with total occupants of 162 persons. The Pilot in Command (PIC) acted as Pilot Monitoring (PM) and the Second in Command (SIC) acted as Pilot Flying (PF).

The Flight Data Recorder (FDR) recorded that 4 master cautions activated following the failure of the Rudder Travel Limiter which triggered Electronic Centralized Aircraft Monitoring (ECAM) message of AUTO FLT RUD TRV LIM SYS. The crew performed the ECAM procedure on the first three master caution activations. After the 4th master caution, the FDR recorded different pilot action and the parameters showed similar signature to those on 25 December 2014 when the FAC CBs were pulled on the ground. This pilot action resulted on the 5th and 6th master caution activations which correspond respectively to ECAM message of AUTO FLT FAC 1 FAULT and AUTO FLT FAC 1+2 FAULT

Following two FAC fault, the autopilot and auto-thrust disengaged and the flight control reverted to Alternate Law which means the aircraft lost several protections available in Normal Law. The aircraft entered an upset condition and the stall warning activated until the end of recording.

Participating in the investigation of this accident were Australian ATSB, French BEA, Singapore AAIB and MOT Malaysia as accredited representatives.

The investigation concluded that contributing factors to this accident were:

- The cracking of a solder joint of both channel A and B resulted in loss of electrical continuity and led to RTLU failure.
- The existing maintenance data analysis led to unresolved repetitive faults occurring with shorter intervals. The same fault occurred 4 times during the flight.
- The flight crew action to the first 3 faults in accordance with the ECAM messages. Following the fourth fault, the FDR recorded different signatures that were similar to the FAC CB's being reset resulting in electrical interruption to the FAC's.
- The electrical interruption to the FAC caused the autopilot to disengage and the flight control logic to change from Normal Law to Alternate Law, the rudder deflecting 2° to the left resulting the aircraft rolling up to 54° angle of bank.
- Subsequent flight crew action leading to inability to control the aircraft in the Alternate Law resulted in the aircraft departing from the normal flight envelope and entering prolonged stall condition that was beyond the capability of the flight crew to recover.

Issues such as flight approval considered did not contribute to the accident and was not investigated. The FDR data did not show any indication of the weather condition affecting the aircraft.

Following this accident, the Indonesia Air Asia has performed several safety actions.

KNKT issued several recommendations to Indonesia Air Asia, Director General of Civil Aviation (DGCA), US Federal Aviation Administration and European Aviation Safety Administration (EASA) and Airbus.

1 FACTUAL INFORMATION

1.1 History of Flight

On 28 December 2014, an Airbus A320-216 aircraft registered as PK-AXC was being operated by PT. Indonesia Air Asia on a scheduled flight from Juanda International Airport Surabaya, Indonesia to Changi International Airport, Singapore. The aircraft departed at 0535 LT (2235 UTC¹, 27 December 2014) and was cruising at 32,000 feet (FL320) via ATS (Air Traffic Services) route Mike 635 (M635).

The Pilot in Command (PIC) acted as Pilot Monitoring (PM) and the Second in Command (SIC) acted as Pilot Flying (PF).

The totals of 162 persons were on board this flight consisted of two pilots, four flight attendants and 156 passengers including one company engineer.



Figure 1: Archive photo of the aircraft

The sequence of events retrieved from both of Flight Data Recorder (FDR) and Cockpit Voice Recorder (CVR) were as follows:

2231 UTC, the aircraft started to taxi.

2235 UTC, the aircraft took off.

2249 UTC, the flight reached cruising altitude of 32000 feet (Flight Level 320).

At 2257 UTC, the PF asked for anti-ice ON and the flight attendant announced to the passengers to return to their seat and fasten the seat belt due to weather condition and possibility of turbulence.

At 2300 UTC, the Electronic Centralized Aircraft Monitoring (ECAM) amber advisory AUTO FLT RUD TRV LIM 1 appeared. The PF asked “ECAM action”.

¹ UTC (Universal Time Coordinate) is the primary time standard by which the world regulates clocks and time. It is, within about 1 second, mean solar time at 0° longitude; it does not observe daylight saving time. It is one of several closely related successors to Greenwich Mean Time (GMT). Local time of the point of departure and the accident site was UTC + 7.

At 2301 UTC, FDR recorded failure on both Rudder Travel Limiter Units and triggered a chime and master caution light. The ECAM message showed “AUTO FLT RUD TRV LIM SYS” (Auto Flight Rudder Travel Limiter System). The PIC read and performed the ECAM action of AUTO FLT RUD TRV LIM SYS to set Flight Augmentation Computer (FAC) 1 and 2 push-buttons on the overhead panel to OFF then to ON one by one. Both Rudder Travel Limiter Units returned to function normally.

At 2304 UTC, the PM requested to the Ujung Pandang Upper West² controller to deviate 15 miles left of track for weather avoidance and was approved by the controller. The aircraft then flew on a heading of 310°.

At 2306UTC, the SIC conducted cruise crew briefing including in the case of one engine inoperative or emergency descent and that Semarang Airport would be the alternate airport.

At 2309 UTC, the FDR recorded the second failure on both Rudder Travel Limiter Units and triggered a chime and master caution light. The pilots repeated the ECAM action and both Rudder Travel Limiter Units returned to function normally.

At 2311 UTC, the pilot contacted the Jakarta Upper Control³ controller and informed that the flight turned to the left off the M635 to avoid weather. The information was acknowledged and identified on the radar screen by the Jakarta Radar controller. The Jakarta Radar controller instructed the pilot to report when clear of the weather.

At 2312 UTC, the pilot requested for a higher level to FL 380 when possible and the Jakarta Radar controller asked the pilot to standby.

At 2313:41 UTC, the single chime sounded and the amber ECAM message “AUTO FLT RUD TRV LIM SYS” was displayed. This was the third failure on both Rudder Travel Limiter Units on this flight. The pilots performed the ECAM actions and the system returned to function normally.

At 2315:36 UTC, the fourth failure on both Rudder Travel Limiter Units and triggered ECAM message “AUTO FLT RUD TRV LIM SYS”, chime and master caution light.

At 2316 UTC, the Jakarta Radar controller issued a clearance to the pilot to climb to FL 340 but was not replied by the pilot. The Jakarta Radar controller then called the pilot for several times but was not replied.

At 2316:27 UTC, the fifth Master Caution which was triggered by FAC 1 FAULT followed by FDR signature of alteration⁴of parameters of components controlled by

2 Ujung Pandang Upper West Control sector controls air traffic at Ujung Pandang upper west FIR area which commonly called as “Ujung Radar”.

3 Jakarta Upper Control sector upper Tanjung Pandan, controls air traffic on the one sectors of Jakarta FIR area which commonly called as “Jakarta Radar”.

4 These specific FDR parameter pattern occurs when data to be recorded is not available at the FDR entry interface. This parameter unavailability could be due to the emitter equipment is set OFF, or de-energized, or due to wiring or other issue making that the information do not arrive at the FDR interface. In such situation the FDR applies alternative recording of binary recorded data, for example, at one sample it records the minimum parameter value then, at the next sample records the maximum parameter value and so on, as soon as the parameter is not refresh or not provided by the relevant equipment.

FAC 1 such as RTLU 1, Windshear Detection 1 and Rudder Travel Limiter Actuator 1.

At 2316:44 UTC, the sixth Master Caution triggered by AUTO FLT FAC 1 + 2 FAULT and followed by FDR signature of alteration of parameters of components controlled by FAC 2 such as RTLU 2, Windshear Detection 2 and Rudder Travel Limiter Actuator 2. The Auto Pilot (A/P) and the Auto-thrust (A/THR) disengaged. Flight control law reverted from Normal Law to Alternate Law. The aircraft started to roll to the left up to 54° angle of bank.

Nine seconds after the autopilot disengaged, the right side-stick activated. The aircraft roll angle reduced to 9° left and then rolled back to 53° left. The input on the right side-stick was mostly pitch up and the aircraft climbed up to approximately 38,000 feet with a climb rate of up to 11,000 feet per minute.

At 2317:18 UTC, the stall warning activated and at 2317:22 UTC stopped for 1 second then continued until the end of recording.

The first left side stick input was at 2317:03 UTC for 2 seconds and at 2317:15 UTC another input for 2 seconds, then since 2317:29 UTC the input continued until the end of the recording.

The right side stick input was mostly at maximum pitch up until the end of recording.

The lowest ISIS speed recorded was 55 knots. The ISIS speed recorded fluctuated at an average of 140 knots until the end of the recording.

At 2317:41 UTC the aircraft reached the highest ISIS altitude of 38,500 feet and the largest roll angle of 104° to the left. The aircraft then lost altitude with a descent rate of up to 20,000 feet per minute.

At approximately 29,000 feet the aircraft attitude was wings level with pitch and roll angles of approximately zero with the airspeed varied between 100 and 160 knots. The Angle of Attack (AOA)⁵ was almost constant at approximately 40° up and the stall warning continued until the end of recording. The aircraft then lost altitude with an average rate of 12,000 feet per minute until the end of the recording.

⁵ Angle of Attack (AOA) is the angle between the oncoming air or relative wind, and some reference line on the airplane or wing.



Figure 2: The aircraft flight track

At 2318 UTC, the aircraft disappeared from the Jakarta Radar controller screen. The aircraft last position according to the Automatic Dependent Surveillance-Broadcasting (ADS-B) radar was on coordinate 3°36'48.36"S - 109°41'50.47"E and the aircraft altitude was approximately 24,000 feet.

The last data recorded by FDR was at 2320:35 UTC with ISIS airspeed of 132 kts, pitch 20° up, AOA 50° up, roll 8° to left, the rate of descent 8400 ft/minute and the radio altitude was 118 feet. No emergency message was transmitted by the crew.

1.2 Injuries to Persons

Injuries	Flight crew	Passengers	Total in Aircraft	Others
Fatal	6	156	162	-
Serious	-	-	-	-
Minor/None	-	-	-	-
TOTAL	6	156	162	-

The list of the person on board including the flight crew by nationality (in alphabetical order) is as follows;

France	1
Indonesia	155
Malaysia	1

Singapore	1
South Korea	3
United Kingdom	1

1.3 Damage to Aircraft

The aircraft impacted the water, was destroyed and submerged into the sea bed. The recovered parts included the empennage section, including a part of the rear fuselage, including the vertical stabilizer and rudder. Another recovered part was the fuselage section which included the centre fuselage, the wings and both main landing gears.

Several smaller parts recovered consisted of a number of passenger seats, escape slides, and interior panels that floated and were recovered approximately 30 Nm southeast of the main wreckage.



Figure 3: The recovered tail section being transferred to Kumai Harbour



Figure 4: One section of passenger seats



Figure 5: Centre fuselage section including the wings and main landing gears

1.4 Other Damage

There was no other damage.

1.5 Personnel Information

1.5.1 Pilot in Command

Gender	: Male
Age	: 53 years
Nationality	: Indonesia
Marital status	: Married
Date of joining company	: 04 April 2008
License	: ATP License
Date of issue	: 21 April 1994
Aircraft type rating	: Airbus 320
Instrument rating validity	: 30 November 2015
Medical certificate	: First Class
Last of medical	: 8 July 2014
Validity	: 8 January 2015
Medical limitation	: Shall wear lenses correct for distant and possess glasses that correct the near vision
Last line check	: 22 November 2014
Last proficiency check	: 18 November 2014

Flying experience

Total hours	: 20,537 hours
Total on type	: 4,687 hours
Last 90 days	: 239.87 hours
Last 60 days	: 153.78 hours
Last 24 hours	: 45 minutes
This flight	: 45 minutes

1.5.2 The PIC background and flight experience

The PIC served as a pilot in the Indonesian Air Force from 1983 to 1993 and flew some aircraft types which included jet fighter and transport category and also as a flight instructor on single engine propeller aircraft. After termination of the contract with the Indonesia Air Force, he joined several airlines. On the passenger aircraft, the PIC had experiences of twin engines turbo propeller, jet passenger transport aircraft including as Captain on Boeing B737 and Airbus A320.

The flight experience of the PIC was specified as follows;

- Jet aircraft (F5 fighter, Boeing B737 and Airbus A320) with total hours of 14,848 hours.
- Propeller aircraft (AS-202, T-34C, and Fokker F27) with total hours of 9,636 hours.

The PIC joined the company while IAA operated Boeing B737 fleet. While joining the company he was trained and checked for upset recovery training on Boeing B737 training simulators.

The pilot has been trained according to the Airbus A320 Type Rating Syllabus during Type Qualification (TQ) training. The pilot was introduced to stall recovery in Full Flight Simulator (FFS) on session 4 of the training which focused on handling phase. The training on session 4 consisted of:

- Climb with ADR 1 fault and followed by ADR 2 fault
- Alternate law – stall recovery
- Stall recovery at low altitude
- ILS raw data on alternate law
- High altitude handling (demo) stall recovery at high altitude.

The last proficiency check result was satisfactory without comment from the instructor.

Upset recovery training has not been trained to the pilot on Airbus A320 aircraft type.

1.5.3 The PIC exposure to Rudder Travel Limiter problem

On 25 December 2014, the PIC was conducting a scheduled passenger flight from Surabaya to Kuala Lumpur in PK-AXC. During push back and after both engines had been started, the AUTO FLT RUD TRV LIM SYS message appeared on the ECAM. The PIC decided to return the aircraft to the parking bay and reported the problem to the company engineer.

An engineer came to the cockpit to check and performed trouble shooting on the ECAM. The rectification was estimated to be completed in short time and the pilots stayed in the cockpit.

By referring to the TSM, the engineer then reset the Circuit Breakers (CBs) of the Flight Augmentation Computer (FAC) 1 and 2, and continued with BITE Test⁶ (Build in Test) which apparently addressed the issue.

The PIC and the engineer engaged in a discussion. The PIC asked whether he may perform the same reset action whenever the problem reappeared. The engineer stated that the pilot may reset whenever instructed on the ECAM.

The aircraft was then ready for departure and push back. During push back and after starting engine 2, the AUTO FLT RUD TRV LIM SYS message reappeared on the ECAM. The pilot performed the ECAM action, however the problem still existed. The engineer, who had performed the initial rectification, saw that the aircraft did not move, took over the interphone and communicated with the pilot.

A summary of the interphone communications between the engineer and the pilot was that the problem still existed and all ECAM actions had been performed. The PIC asked to the engineer whether he could reset the system by pulling the FAC CB. Thereafter the engineer saw that the SIC⁷ of this flight leaving his seat. After the CB was reset, the problem still existed and the engineer asked the pilot to return the aircraft to the gate.

After the aircraft parked, the engineer asked the PIC to disembark the passengers and waited in the terminal building, since the rectification might take a long time. After the FAC2 replacement, the engineer then asked the pilot to start both engines to ensure that there was no problem during the power interruption after starting the engines. After both engines started, the problem did not reappear. The captain was satisfied to the rectification and advised that they were ready to depart. The aircraft then flew from Surabaya to Kuala Lumpur and returned without any further problems.

⁶ BITE Test: Build in Test is a test for electrical and computer connection for a system.

⁷ The SIC of this flight was different person to the accident flight

1.5.4 Second in Command

Gender	: Male
Age	: 46 years
Nationality	: French
Marital status	: Single
Date of joining company	: 01 December 2012
License	: ATP License (issued by France Authority). Renewal validation by Indonesia DGCA at 21 November 2014
Date of issue	: 05 November 2014
Aircraft type rating	: Airbus 320
Instrument rating	19 November 2014
Medical certificate	First class
Last of medical	21 October 2014
Validity	21 April 2015
Medical limitation	None
Last line check	14 September 2013 ⁸
Last proficiency check	: 19 November 2014

Flying experience

Total hours	: 2,247 hours
Total on type	: 1,367 hours
Last 90 days	: 151 hours
Last 60 days	: 87.82 hours
Last 24 hours	: 45 minutes
This flight	: 45 minutes

1.5.5 The SIC flight experience background

The SIC was a French citizen. Prior to training as a pilot, he worked as part of the management staff in several positions;

- Technical Project Manager, in charge of the implementation of innovating and added value electronic business solutions for all the branches of the company groups.

⁸ Company policy stated that first officer only required line check on his first type qualification check and first officer performance monitoring was conducted by six monthly simulator check.

- Director of Strategy and Risk Assessment, Total corporate technology.
- Air Total International, Total France project coordinator.

He joined Air Asia Indonesia on 01 December 2012 as his first airline after completing training at the flying school. The SIC had total of 2,247 flying hours and most of his flight experience was on the A320 aircraft.

During a Proficiency Check on 11 May 2013 there was a remark stating that the SIC was to be paired with a senior captain for the next 200 hours. The last proficiency check was conducted on 19 November 2014 and the result was satisfactory.

1.6 Aircraft Information

1.6.1 General

Registration Mark	: PK-AXC
Manufacturer	: Airbus Company
Country of Manufacturer	: France
Type/ Model	: Airbus A320-216
Serial Number	: 3648
Year of manufacture	: 2008
Certificate of Airworthiness	
Issued	: 21 October 2014
Validity	: Valid until 20 October 2015
Category	: Transport
Limitations	: None
Certificate of Registration	
Number	: 2531
Issued	: 22 October 2014
Validity	: Valid until 21 October 2015
Time Since New	: 23,039 Flight Hours
Cycles Since New	: 13,610 Cycles
Last Major Check	: C-Check, 31 January 2014, 6 Years Check, 2-17 September 2014
Last Minor Check	: E-Check, 16 November 2014

1.6.2 Engines

Manufacturer	: SNECMA
Type/Model	: CFM 56-5B6/3
Serial Number-1 engine	: 697957
▪ Time Since New	: 23,039 Hours
▪ Cycles Since New	: 13,610 Cycles
Serial Number-2 engine	: 697958
▪ Time Since New	: 23,039 Hours
▪ Cycles Since New	: 13,610 Cycles

1.6.3 Maintenance History related to RTLU

The investigation collected four different maintenance records:

- a) Maintenance Report 1 (MR1) records for the period of November and December 2014,
- b) Copy of Post Flight Report (PFR) data between 27 November 2014 and 27 December 2014,
- c) Summary of PK-AXC 1 Year Maintenance Report, and
- d) The Reliability Report issued November 2014.

1.6.3.1 Maintenance Report 1 (MR1) and Maintenance Report 2 (MR2)

Referring to the operator Company Maintenance Manual (CMM) chapter 5.1 Technical Log, the Maintenance Report 1 (MR1) is a Technical Log book. Any technical problem arises during the flight should be written in this document and the engineer has to rectify and record the work performs. In chapter 5.1.4, stated “*All maintenance work must be recorded and certified in the Technical Log*”.

Maintenance Report 2 (MR2) is a Deferred Defect Log Book. Deferred defect is an identified aircraft defect which has been assessed as being within the requirement of the MEL or CDL and has had rectification deferred within a specified limit. The CMM chapter 3.7, “MEL/Dispatch Deviation Mandatory Guide”, stated in Chapter 3.7.2 “*No direct entries into the Maintenance Report 2 shall be permitted unless the deferred defect already been entry in MR1 as a reference*”. The procedure regarding deferring the trouble is stated in sub chapter 2.34 in the Engineering Procedure Manual (EPM) chapter 2 Line Maintenance Check.

Defects may be deferred only under the following circumstances:

- i. *Deferrable defects as per MEL categories.*
- ii. *Non-availability of spares.*
- iii. *Item is not listed in MEL but non-airworthy in nature.*
- iv. *Eg. Passenger convenience.*
- v. *Discovery of defects during the check but with insufficient ground time to rectify may be deferred only if allowed by MEL, SRM or relevant manuals or documents.*

Evaluation of MR1 data, in November 2014 found 5 pilot reports related to RTL problem on 10, 13, 20, 22 and 24 November 2014 and in December 2014 found 9 pilot reports related to RTL problem on 1, 12, 14, 19,21, 24, 25 (two cases), and 27 December 2014.

On 19 December 2014, the repetitive RTL problem was inserted to Deferred Defect Log Book (MR2). After completion of the scheduled flight, on MR1 column action taken stated “Check on PFR nor ECAM NIL Fault related defect. Do operational test of AFS as per AMM -96-00-710-001-A result no fault recorded. MR2 closed”. The deferred item on MR2 was closed on the same day.

The MR1 data on 25 December 2014, the aircraft was Return to Apron (RTA) twice due to RTL problem. The engineer replaced the FAC 2, taken from another aircraft that was on maintenance program.

On 26 December 2014, the FAC 2 was replaced with another FAC that was sent from Jakarta and the FAC 2 was put back to the original aircraft.

1.6.3.2 Defect Handling in Line Maintenance using Post Flight Report (PFR)

The Post Flight Report (PFR) is information of system problem which occurs during the flight and displays on the Centralized Fault Display System (CFDS) after completion of a flight.

The PFR messages consist of “Warning/Maintenance Status Messages” which contain information of the warning or maintenance status displayed on the ECAM during the flight and the “Failure Message” which indicates the corresponding faulty component.

The CFDS starts to record the PFR usually at an aircraft speed more than 80 knots during the takeoff roll and stop two minutes 30 seconds after the aircraft is on the ground and the aircraft speed is less than 80 knots.

The following picture is a typical printed PFR.

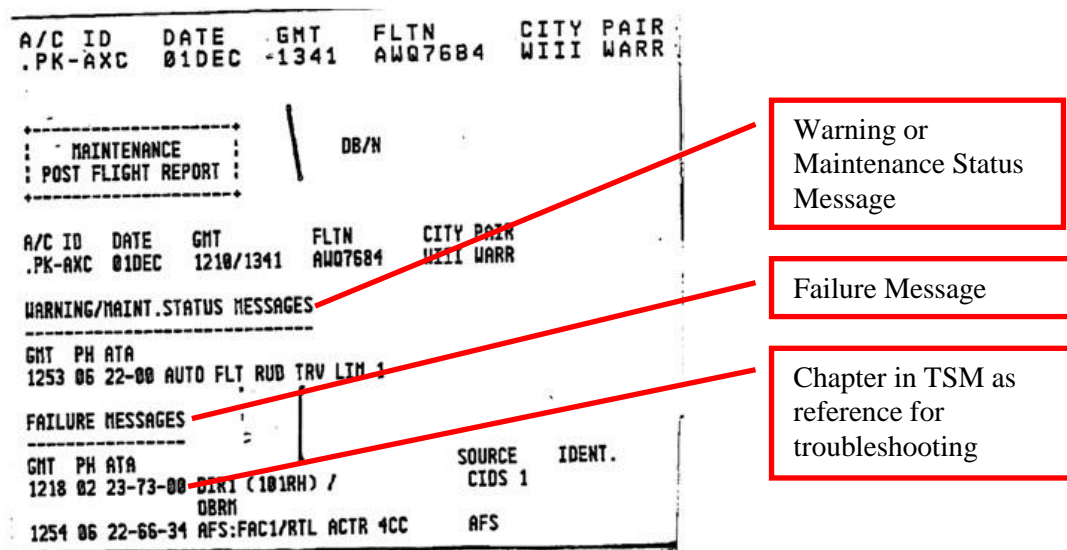

Figure 6: Typical Printed Post Flight Report (PFR)

The Trouble-Shooting Manual (TSM) which is included in the Airbus Manual application software stated that PFR is the main source of information used to initiate trouble-shooting and to decide on the required maintenance action. All IAA line maintenance stations have digital copy of the TSM.

The line maintenance personnel at each station are responsible to collect the PFR and store it at line maintenance station.

Any defect reported by the flight crew via MR1, the line maintenance personnel will check and verified the PFR. If the PFR confirmed of the defect, the maintenance personnel will refer the failure message on the PFR which identify the relevant chapter of the TSM and follow the maintenance action. If the PFR is not available following a defect reported via MR1 due to CFDS or PFR printer problem, the maintenance personnel will refer the TSM with manual searching the defective component. Any maintenance action performed without MR1 reference, the line maintenance personnel does not have obligation to record the maintenance action on the technical log.

Evaluation of the PFR data between 27 November and 27 December 2014 found 11 occurrences related to RTLU 1, RTLU 2 and both RTLU. The detail of the PFR is summarized in Appendix 6.6 of this report.

The PFR Failure Messages were dominated by the corresponding failed component of “AFS: FAC1/RTL ACTR 4CC”.

Other than the RTLU, the PFR data from 27 November to 27 December 2014 also showed repetitive warning messages and failure messages, of which were AIR BLEED and F/CTL ELAC 1 FAULT.

These problems have been inserted to MR2 in which F/CTL ELAC 1 FAULT problems were closed on 12 December 2014 and the AIR BLEED problems were closed on 22 December 2014.

1.6.3.3 Summary of PK-AXC 1 Year Maintenance Report

The operator Planning and Technical Service department compiled the maintenance data of PK-AXC into PK-AXC 1 Year Maintenance Report to assist the investigation. This report was a system generated by Airline Maintenance and Operation System (AMOS). The data recorded is uploaded by the maintenance personnel at all line maintenance stations. This report consists of the information collected from MR1, Cabin Maintenance and Scheduled Inspection.

The summary of the PK-AXC 1 Year Maintenance Report is available in Appendix 6.6 of this report.

The PK-AXC 1 Year Maintenance Report recorded 23 occurrences related with the RTLU problem. The composition of the warning messages is as follows:

- AUTO FLT RUD TRV LIM 1 11 occurrences
- AUTO FLT RUD TRV LIM 2 3 occurrences
- AUTO FLT RUD TRV LIM SYS 9 occurrences

The numbers RTLU occurrences as per PK-AXC 1 Year Maintenance Report were summarized in the following graph.

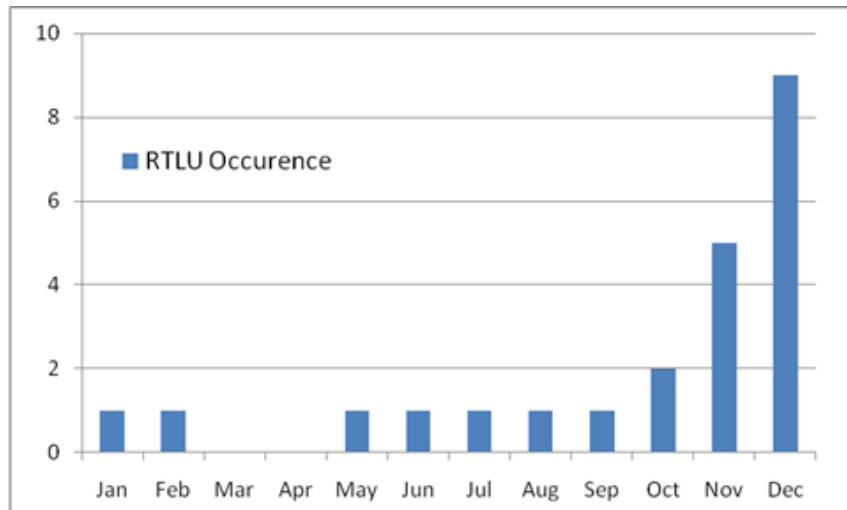

Figure 7: Numbers of the RTLU Occurrences in 2014

The workaround solution of the maintenance staff on the RTLU problems were mostly by resetting computer by either resetting the FAC push button and followed by AFS test or pulling the associated CBs and the rectification was performed according to the A320 TSM.

1.6.3.4 Reliability Report Issued on November 2014

The repetitive problems of RTLU were also stated in the Reliability Report issued on November 2014.

Chapter 4.1 Repetitive Defect at sub chapter 4.1.1 of this Reliability Report stated that there were 4 pilot reports regarding the RTL problem. The complete statement in the Reliability Report regarding the repetitive troubles is as follows:

4.1.1. DEFECT REPORTED: AUTO FLT RUD TRV LIM 1 – ATA 22

- 4 Pireps (Pilot Report) were reported on PK-AXC

Common Part: Auto Flight System

Action: the trouble shoot of AFS as per TSM 22-61-00-810-803-A is performed the operational test as per AMM 22-99-00-710-001⁹. No further action required.

The Airbus Maintenance Manual (AMM) chapter 22-96-00-710-001 is to perform the Operational Test of Auto Flight System (AFS) that can be done by maintenance personnel at line maintenance.

1.6.3.5 Last Three Day Records

The last three days prior to the occurrence, the maintenance history related to the RTLU were as follows:

- 25 December 2014: After two occurrences of AUTO FLT RUD TRV LIM SYS problem, referring to the ECAM and Trouble Shooting Manual (TSM). The

⁹ The AMM 22-99-00-710-001 is incorrect due to typographical error, the correct references is AMM 22-96-00-710-001

engineer then reset the Circuit Breakers (CBs) of the Flight Augmentation Computer (FAC) 1 and 2, and continued with BITE Test¹⁰ (Build in Test) which in accordance with TSM 22-61-00-810-803-A and AMM 22-66-34 PB 401 was satisfactorily resolved.

- The aircraft was then ready for departure and push back. During push back and after starting engine 2, the AUTO FLT RUD TRV LIM SYS fault reappeared. The pilot performed the ECAM action, however the problem still existed. The engineer then asked the pilot to return the aircraft to the gate.
- The engineer performed troubleshooting by referring to TSM 22-66-00-810-818-A and the manual stated that the FAC 2 shall be replaced. The engineer noticed that a spare FAC was not available in the maintenance store in Surabaya. The engineer removed the FAC 2 from another aircraft that was on maintenance program. The removal and installation of the component referred to AMM 22-66-34 PB 401.
- 26 December 2014: The aircraft performed a series of flights and arrived at Surabaya at 1508 UTC (2208 LT) without any problem. The FAC 2 which was taken from another aircraft was removed and put back to the original aircraft. The FAC 2 of PK-AXC was replaced by new spare FAC that had been arrived from Jakarta. A BITE test was performed and the result was satisfactory. After the installation of FAC 2, the aircraft performed flights from Surabaya to Kuala Lumpur and there was no problem reported related to the Rudder Travel Limiter.
- 27 December 2014: The pilot wrote on MR1 after arrival from Kuala Lumpur, that during taxi-in at Surabaya, the AUTO FLT RUD TRV LIM SYS illuminated on ECAM momentarily. The maintenance personnel examined the information on the Centralized Fault Display System (CFDS) print-out but there was no PFR message. The maintenance personnel continued to reset the FAC 1 and 2 and performed the AFS check with a PASS result and the RTLU fault message did not reappear further 4 sectors.

1.6.3.6 FAC Shop Finding Report

The removed FAC on 25 December 2014 from PK-AXC was sent to an approved workshop. The reason of removal as stated on the shop finding report was “AUTO FLT RUD TRV LIM SYS”. The inspection did not find any problem and stated “REPORTED FAULT NOT CONFIRMED” and the unit was returned to service on 26 January 2015.

1.6.3.7 Summary

An evaluation of the maintenance data showed that the maintenance action following the RTLU problems were in accordance with the TSM. The actions were mostly resolved by resetting the computer by either pulling the associated CB or resetting the FAC push button and followed by an AFS test. The replacement of FAC2 was the only different action taken by the line maintenance personnel.

¹⁰ BITE Test or Build in Test is a test for electrical and computer connection for a system.

1.6.4 Weight and Balance (Load and Trim Sheet)

The weight and balance information available in the Load and Trim Sheet issued by the Flight Operation at Surabaya prior to dispatch contained the following data:

- The total payload	14,220 kg
- Cargo	Nil
- Zero Fuel Weight	57,100 kg
- Fuel on board	7,725 kg
- Takeoff weight	64,825 kg (Maximum 73500 kg)
- Burn fuel	5,121 kg (for complete flight)
- Estimated Landing Weight	59,704 kg (Maximum 66000 kg)
- Remaining fuel at arrival	2,604 kg

The weight and balance sheet showed that the total baggage on board of 1258 kg all were located in the compartment 3 while the maximum capacity for this compartment was 2268 kg (5000 lbs).

The takeoff Centre of Gravity (CG) was 31.5% of the mean Aerodynamic Chord (MAC) and the pitch trim was 0.7 down and the MAC of the Zero Fuel Weight (ZFW) was 33.6% of the MAC indicating that the aircraft was operated within the approved weight and balance envelope.

1.6.5 Aircraft Systems

This sub-chapter describes the relevant aircraft system discussed in this report. Some descriptions are general outline of aircraft system and those written in italics are quotes from the aircraft operator or manufacturer's manuals.

1.6.5.1 Flight Control System

The Flight Control System of the Airbus A320 has a 'fly by wire' concept. The fly-by-wire system was designed and certified to render the new generation of aircraft even more safe, cost effective, and pleasant to fly.

Flight control surfaces are all electrically-controlled, and hydraulically-activated.

Pitch axis is controlled by the elevators which are electrically operated and Trimmable Horizontal Stabilizer (THS) which is electrically operated for normal or alternate control and mechanically operated for manual trim control.

The maximum elevator deflection is 30 ° nose up, and 17 ° nose down. The maximum THS deflection is 13.5 ° nose up, and 4 ° nose down.

Roll axis is controlled by ailerons and spoilers which are electrically operated. Yaw axis is controlled by the rudder which is mechanically operated, however control for yaw damping, turn coordination and trim is electrical. The stabilizer and rudder can also be mechanically-controlled.

Pilots use side-sticks to fly the aircraft in pitch and roll (and in yaw, indirectly, through turn coordination).

Cockpit Controls

Each pilot has a side-stick controller with which to exercise manual control of pitch and roll. These are on their respective lateral consoles. The two side-stick controllers are not coupled mechanically, and they send separate sets of electronic signals to the flight control computers. Two pairs of pedals, which are rigidly interconnected, give the pilots mechanical control of the rudder.

The pilots use mechanically interconnected hand wheels on each side of the centre pedestal to control the trimmable horizontal stabilizer.

The pilots use a single control on the centre pedestal to set the rudder trim. There is no manual switch for trimming the ailerons.

Computers

Seven flight control computers process the pilot and autopilot inputs according to normal, alternate, or direct flight control laws. Computers interpret pilot input and move the flight control surfaces, as necessary, to follow the pilot inputs.

- 2 units of ELAC (Elevator Aileron Computer) for normal elevator and stabilizer control.
- 3 units of SEC (Spoilers Elevator Computer) for spoilers control. Standby elevator and stabilizer control.
- 2 units of FAC (Flight Augmentation Computer) for electrical rudder control.

In addition to those, 2 units of Flight Control Data Concentrators (FCDC) acquire data from the ELACs and SECs and send it to the electronic instrument system (EIS) and the centralized fault display system (CFDS). A detailed discussion of FAC is described in chapter 1.6.5.6 of this report.

In normal operations, ELAC2 controls the elevators and the horizontal stabilizer, and the green and yellow hydraulic jacks drive the left and right elevator surfaces respectively.

Yaw Control

One rudder surface controls yaw. The yaw damping and turn coordination functions are automatic.

The ELACs compute yaw orders for coordinating turns and damping yaw oscillations, and transmit them to the FACs. The pilots can use conventional rudder pedals to control the rudder.

Three independent hydraulic servo jacks, operating in parallel, actuate the rudder. In automatic operation (yaw damping, turn coordination) the green servo actuator drives all three servo jacks. A yellow servo actuator remains synchronized and takes over if there is a failure.

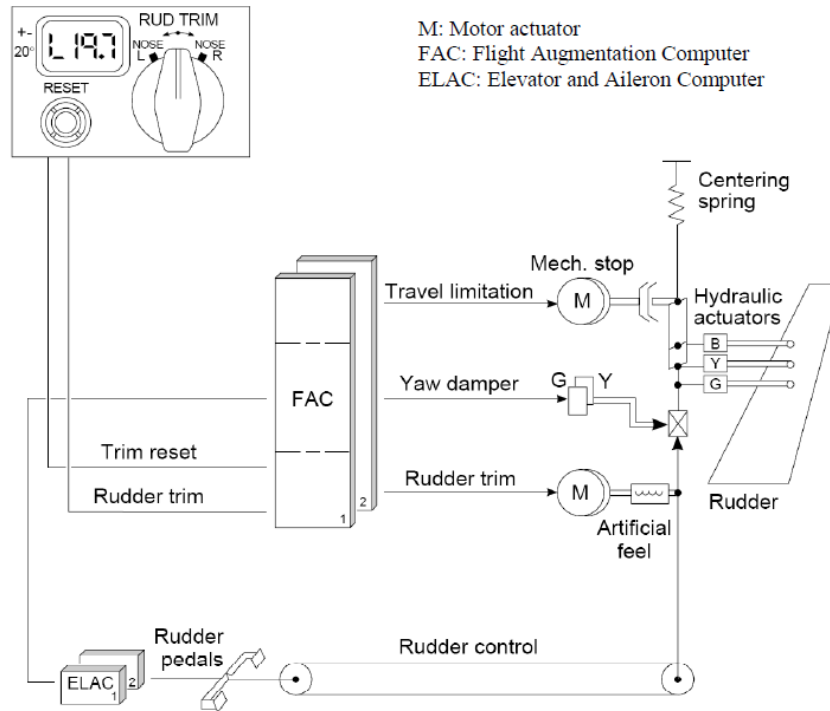

Figure 8: Rudder command architecture

1.6.5.2 Control Law

1. Normal Law

The flight control system has GROUND MODE and FLIGHT MODE. The flight mode is active from takeoff to landing.

When the aircraft is in the FLIGHT mode, normal law combines control of the ailerons, spoilers (except N° 1 spoilers), and rudder (for turn coordination) in the side-stick. While the system thereby gives the pilot control of the roll and heading, it also limits the roll rate and bank angle, coordinates the turns, and damps any Dutch roll.

The roll rate requested by the pilot during flight is proportional to the side-stick deflection, with a maximum rate of 15°/s when the side-stick is at the stop.

Protections

The normal law protects the aircraft throughout the flight envelope, as follows:

- load factor limitation; is automatically limited to +2.5 g to -1 g for clean configuration and +2 g to 0 for other configurations
- pitch attitude protection is limited to 30° nose up in configuration 0 to 3 (progressively reduced to 25° at low speed; 25° nose up in configuration FULL (progressively reduced to 20° at low speed) and 15° nose down (indicated by green symbols “=” on the PFD’s pitch scale).

The flight director bars disappear from the PFD when the pitch attitude exceeds 25° up or 13° down. They return to the display when the pitch angle returns to the region between 22° up and 10° down.

- high Angle of Attack (AOA) protection: Under normal law, when the angle-of-attack becomes greater than α_{prot} (Alpha Protection), the system switches elevator control from normal mode to a protection mode, in which the angle-of-attack is proportional to side-stick deflection. That is, in the α_{prot} range, from α_{prot} to αMAX , the side-stick commands α directly. However, the angle-of-attack will not exceed αMAX , even if the pilot gently pulls the side-stick all the way back. If the pilot releases the side-stick, the angle-of-attack returns to α_{prot} and stays there. This protection against stall and wind shear has priority over all other protections. The autopilot will disconnect if the α_{prot} is active.
- High-speed protection: The aircraft automatically recovers, following a high speed upset. Depending on the flight conditions (high acceleration, low pitch attitude), High Speed Protection is activated at/or above VMO/MMO. The autopilot disconnects, when High Speed Protection becomes active. High Speed Protection is deactivated, when the aircraft speed decreases below VMO/MMO, where the usual normal control laws are recovered.
- LOW ENERGY WARNING: The low energy warning is computed by the FAC.

Bank angle protection

Inside the normal flight envelope, the system maintains positive spiral static stability for bank angles above 33°. If the pilot releases the side-stick at a bank angle greater than 33°, the bank angle automatically reduces to 33°. Up to 33°, the system holds the roll attitude constant when the side-stick is at neutral. If the pilot holds full lateral side-stick deflection, the bank angle goes to 67° and no further.

If Angle-of-Attack protection is active, and the pilot maintains full lateral deflection on the side-stick, the bank angle will not go beyond 45°. If High Speed Protection is active, and the pilot maintains full lateral deflection on the side-stick, the bank angle will not go beyond 40°. If high speed protection is operative, the system maintains positive spiral static stability from a bank angle of 0°, so that with the side-stick released, the aircraft always returns to a bank angle of 0°.

If the bank angle exceeds 45°, the autopilot disconnects and the FD bars disappear. The FD bars return when the bank angle decreases to less than 40°.

2. Alternate Law

Depending on the failures occurring to the flight control system, or on its peripherals, there are 3 levels of reconfiguration:

- Alternate law
 - They are two levels of alternate law with and without reduced protections.
- Direct law
- Mechanical

In flight, the alternate law pitch mode follows a load-factor demand law much as the normal law pitch mode does, but it has less built-in protection (reduced protections). When the aircraft is flying in pitch alternate law, lateral control follows the roll direct law associated with yaw alternate or mechanical. Referring to DSC-27-20-20 Direct Law, only the yaw damping function is available. Damper authority is limited

to $\pm 5^\circ$ of rudder deflection. The load factor limitation is similar to that under normal law. There is no pitch attitude protection. Amber Xs replace the green double bars “=” on the PFD.

During the Alternate Law, Bank Angle Protection is not provided.

Note: The AP (auto-pilot) will disconnect, if speed exceeds VMO/MMO, or if the bank angle exceeds 45° .

Low Speed Stability

Artificial low speed stability replaces the normal angle-of-attack protection. It is available for all slat/flap configurations, and the low speed stability is active from about 5 kts up to about 10 kts above stall warning speed, depending on the aircraft's gross weight and slats/flaps configuration.

A gentle progressive nose down signal is introduced, which tends to keep the speed from falling below these values.

The system also injects bank-angle compensation, so that operation effectively maintains a constant angle of attack.

In addition, audio stall warning (crickets + “STALL” synthetic voice message) is activated at an appropriate margin from the stall condition.

The PFD speed scale is modified to show a black/red barber pole below the stall warning.

The α floor protection is inoperative.

3. Direct Law

Pitch control: The pitch direct law is a direct stick-to-elevator relationship (elevator deflection is proportional to stick deflection).

In all configurations the maximum elevator deflection varies as a function of CG Control with the CG aft. There is no automatic trim the pilot must trim manually.

1.6.5.3 Lateral Consoles

SIDESTICKS

Each pilot has on his lateral console a sidestick he can use to control pitch and roll manually. Each sidestick is spring-loaded to neutral.

When the autopilot is engaged, a solenoid-operated detent locks both sidesticks in the neutral position. If the pilot applies a force above a given threshold (5 daN in pitch, 3.5 daN in roll) the stick becomes free and the autopilot disengages.

The hand grip has two switches:

- *Autopilot disconnect and sidestick takeover pushbutton.*
- *Push-to-talk button.*

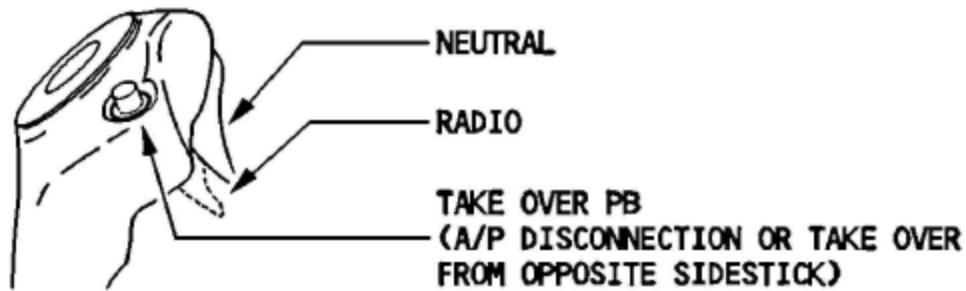

Sidestick priority logic

- When only one pilot operates the sidestick, it sends his control signals to the computers.
- When the pilots move both side sticks simultaneously in the same or opposite direction and neither takes priority, the system adds the signals of both pilots algebraically. The total is limited to the signal that would result from the maximum deflection of a single sidestick.

Note: In the event of simultaneous input on both sidesticks (2° deflection off the neutral position in any direction) the two green SIDE STICK PRIORITY lights on the glare shield come on and “DUAL INPUT” voice message is activated.

A pilot can deactivate the other stick and take full control by pressing and keeping pressed his priority takeover pushbutton.

For latching the priority condition, it is recommended to press the takeover push button for more than 40 s.

This allows the pilot to release his takeover push button without losing priority.

However, a pilot can at any time reactivate a deactivated stick by momentarily pressing the takeover push button on either stick.

If both pilots press their takeover pushbuttons, the pilot that presses last gets priority.

Note: If an autopilot is engaged, any action on a takeover pushbutton disengages it.

In a priority situation

- A red light comes on in front of the pilot whose stick is deactivated.
- A green light comes on in front of the pilot who has taken control, if the other stick is not in the neutral position (to indicate a potential and unwanted control demand).

Note: If the aircraft is on the ground and commencing its takeoff run and one stick is deactivated, this triggers the takeoff “CONFIG” warning.

1.6.5.4 Characteristic of pitch and lateral

Pitch Control

When the PF performs sidestick inputs, a constant G-load maneuver is ordered, and the aircraft responds with a G-Load/Pitch rate. Therefore, the PF’s order is

consistent with the response that is "naturally" expected from the aircraft: Pitch rate at low speed; Flight Path Rate or G, at high speed.

So, if there is no input on the stick:

- The aircraft maintains the flight path, even in case of speed changes
- In case of configuration changes or thrust variations, the aircraft compensates for the pitching moment effects
- In turbulence, small deviations occur on the flight path. However, the aircraft tends to regain a steady condition.

Airbus Pitch Characteristic

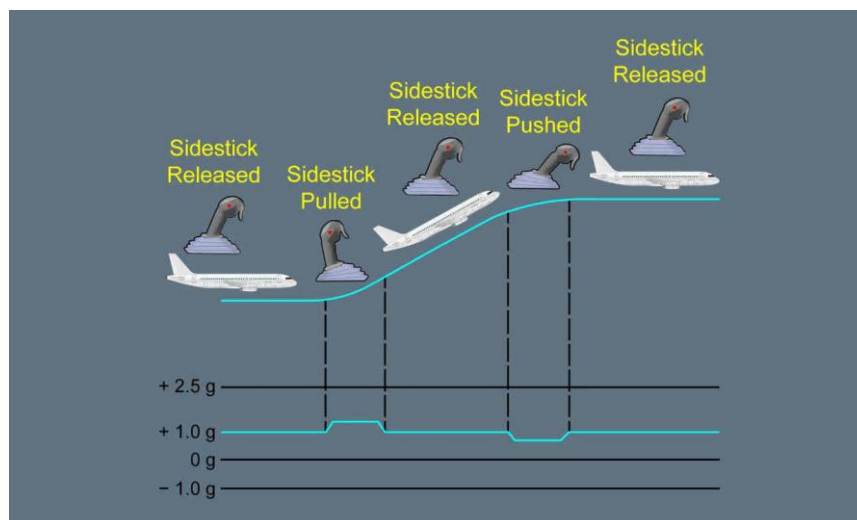

Operational Recommendation:

From the moment the aircraft is stable and auto-trimmed, the PF needs to perform minor corrections on the sidestick, if the aircraft deviates from its intended flight path. The PF should not force the sidestick, or over control it. If the PF suspects an over control, they should release the sidestick.

Lateral Control

When the PF performs a lateral input on the sidestick, a roll rate is ordered and naturally obtained.

Therefore, at a bank angle of less than 33°, with no input on the sidestick, a zero roll rate is ordered, and the current bank angle is maintained. Consequently, the aircraft is laterally stable, and no aileron trim is required.

However, lateral law is also a mixture of roll and yaw demand with:

- Automatic turn coordination
- Automatic yaw damping
- Initial yaw damper response to a major aircraft asymmetry.

In addition, if the bank angle is less than 33°, pitch compensation is provided. If the bank angle is greater than 33°, spiral stability is reintroduced and pitch compensation is no longer available. This is because, in normal situations, there is

no operational reason to fly with such high bank angles for a long period of time.

Airbus Lateral Characteristic

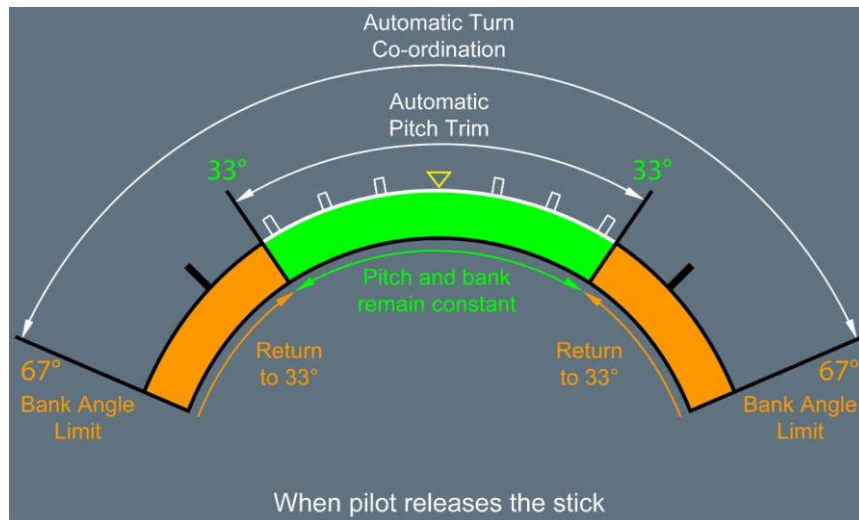

Operational Recommendation:

During a normal turn (bank angle less than 33°), in level flight:

- The PF moves the sidestick laterally (the more the sidestick is moved laterally, the greater the resulting roll rate - e.g. 15°/s at max deflection)
- It is not necessary to make a pitch correction
- It is not necessary to use the rudder.

In the case of steep turns (bank angle greater than 33°), the PF must apply:

- Lateral pressure on the sidestick to maintain bank
- Aft pressure on the sidestick to maintain level flight.

1.6.5.5 Rudder Travel Limitation

This function limits rudder deflection based on speed in order to avoid high structural loads. It is governed by the following law:

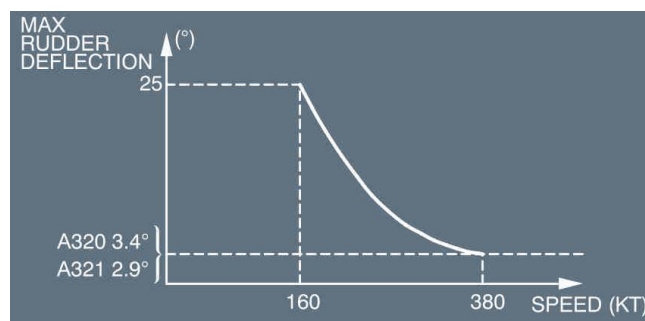

If both FACs lose the rudder travel limitation function, the value of the rudder deflection limit is locked at the time of the second failure.

When the slats are extended, the FACs automatically set the rudder deflection limit at the low-speed setting (maximum authorized deflection).

1.6.5.6 Flight Augmentation Computer (FAC)

Referring to the Flight Crew Operation Manual (FCOM) revision on 7 April 2012, on Chapter AIRCRAFT SYSTEMS sub chapter AUTO FLIGHT – FLIGHT AUGMENTATION, it is described:

The aircraft has two flight augmentation computers (FACs) that perform four main functions:

- *Yaw function*
 - *Yaw damping and turn coordination*
 - *Rudder trim*
 - *Rudder travel limitation*
- *Flight envelope function*
 - *PFD speed scale management*
- *Minimum/maximum speed computation*
- *Manoeuvring speed computation*
 - *Alpha-floor protection*
- *Low-Energy Warning function*
- *Windshear detection function*

In performing these functions the FAC uses independent channels:

- *Yaw damper*
- *Rudder trim*
- *Rudder travel limit*
- *Flight envelope*

Each FAC interfaces with the elevator aileron computers (ELACs) when the autopilots (AP) are disengaged or with the FMGS when at least one AP is engaged. Both FACs engage automatically at power-up. The pilot can disengage or reset each FAC (in case of failure) by means of a pushbutton on the flight control overhead panel.

When a FAC is disengaged (FAC pushbutton set off) but still valid, the flight envelope function of the FAC remains active. If both FACs are valid, FAC1 controls the yaw damper, turn coordination, rudder trim, and rudder travel limit, and FAC2 is in standby.

FAC1 keeps the aircraft within the flight envelope through FD1; FAC2 performs this function through FD2. If a failure is detected on any channel of FAC1, FAC2 takes over the corresponding channel.

Yaw damping stabilizes the aircraft in yaw and coordinates its turns.

In automatic flight (AP engaged) during takeoff and go around, it assists rudder application after an engine failure (short-term yaw compensation).

Note: When the AP is engaged, the FMGS sends orders to the FAC to give:

- *Yaw damping during approach*
- *Yaw control for runway alignment in ROLL OUT mode.*

1.6.5.7 The location of FAC 1-2 Push Button and Circuit Breakers

The location of the FAC 1-2 Push Button and the FAC 1 Circuit Breakers are on the overhead panel and within pilot's hand range as shown in the figure below.

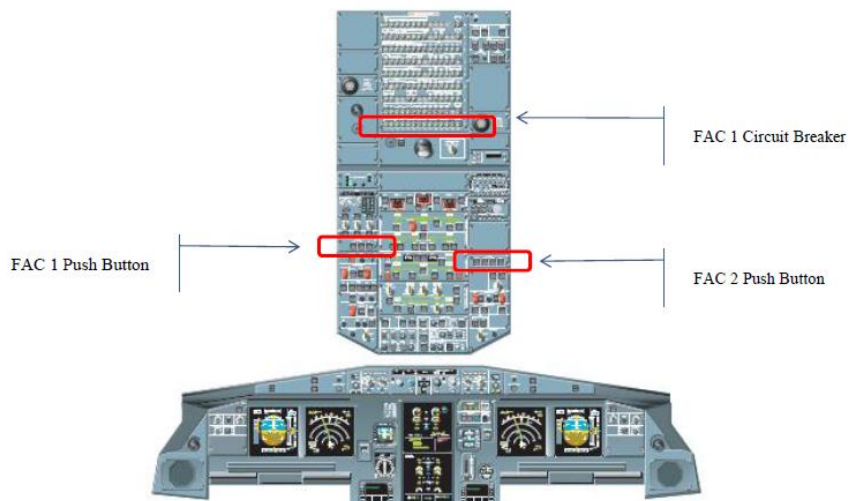

Figure 9: The overhead panel shows the location of FAC 1 CBs, FAC 1 and 2 push buttons

The location of the FAC 2 circuit breakers is on the circuit breaker panel behind the First Officer's seat. The illustration of the cockpit layout including both pilot seats and the circuit breaker panel is shown in the figure below.

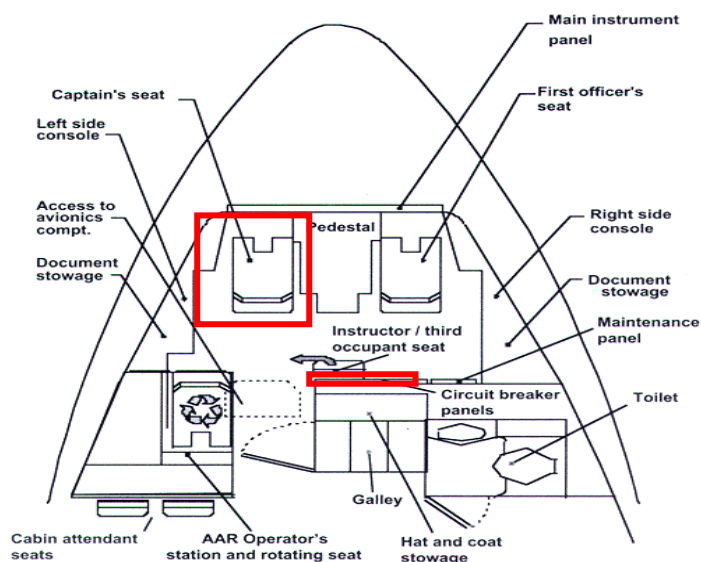

Figure 10: The location of FAC 2 CB, behind the First Officer's seat (red line)

1.6.5.8 Display Management Switching Panel

The following chapter are the summary of the Display Management Switching system.

The Display Management Switching Panel consists of 4 switches:

- ATT HDG is to switch the source of heading information from normal to alternate source of heading information.
- AIR DATA is to switch the source of air data information from normal to alternate source of air data information.
- EIS DMC is to switch the source of Display Management Computer (DMC).
- ECAM/ND XFR is to switch the source ECAM or Navigation Display (ND).

All switches on this panel have 3 selections they are CAPT3, NORM and F/O 3 except for ECAM/ND XFR, the selection is CAPT, NORM and F/O.

Normally all switch are positioned on NORM selection, mean that all of the source are coming from co-location sources (i.e. system 1 for Captain, system 2 for F/O and system 3 is standby).

In case of failure of either of the related system sources for Captain or F/O side, they can alternate it by selecting the switch to either CAPT 3 or F/O 3 (CAPT or F/O for ECAM/ND XFR).

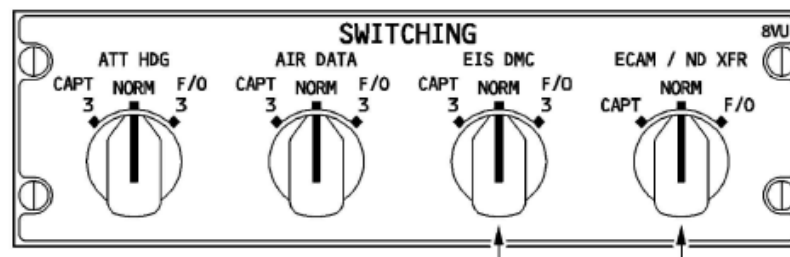

Figure 11: Switching panel on pedestal

1.6.5.9 Air Data System Schematic

Pitot Static Configuration is as follow:

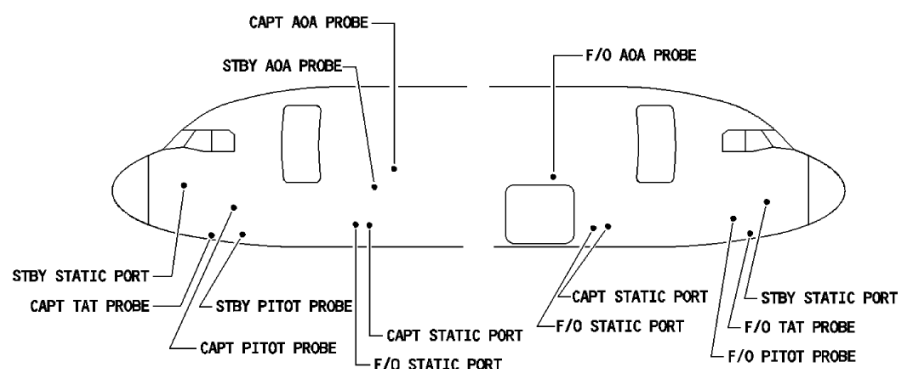

Figure 12: The Pitot Static Configuration

The Air Data and Inertial Reference System (ADIRS) supply the data of temperature, anemometric, barometric and inertial parameters to the EFIS system (PFD and ND) and to other systems. The 3 (three) ADIRS obtained the air data information from 3 (three) Pitot Probes and 6 (six) Static Pressure Probes. Primary pitot and static pressure probes are obtained from Captain and F/O Pitot Probes. The standby information or Integrated Standby Instrument System (ISIS) is obtained from Standby Pitot and Statics Probes, common with ADIRU3.

The line probes schematic is as follows:

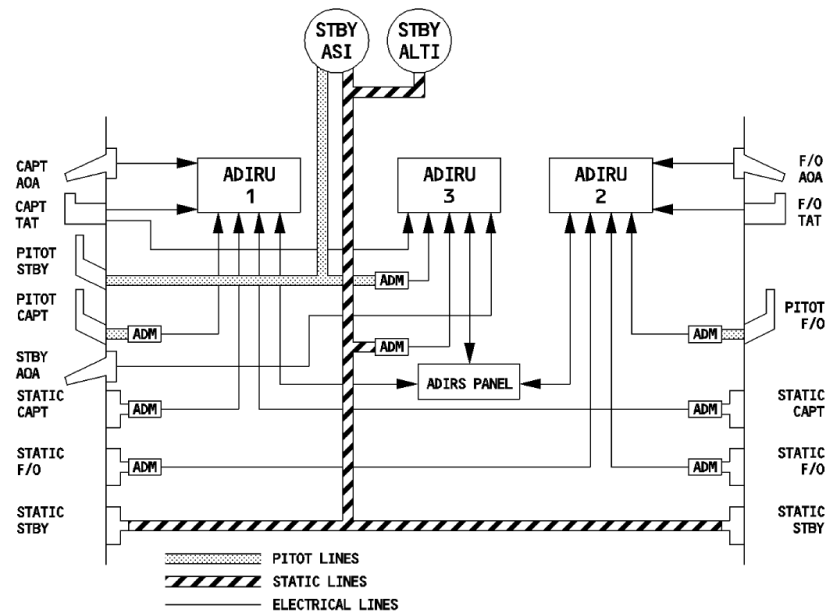

Figure 13: line probes schematic

1.6.5.10 ECAM control panel

FCTM revision 16 July 2014; Chapter; ECAM: Operation philosophy.

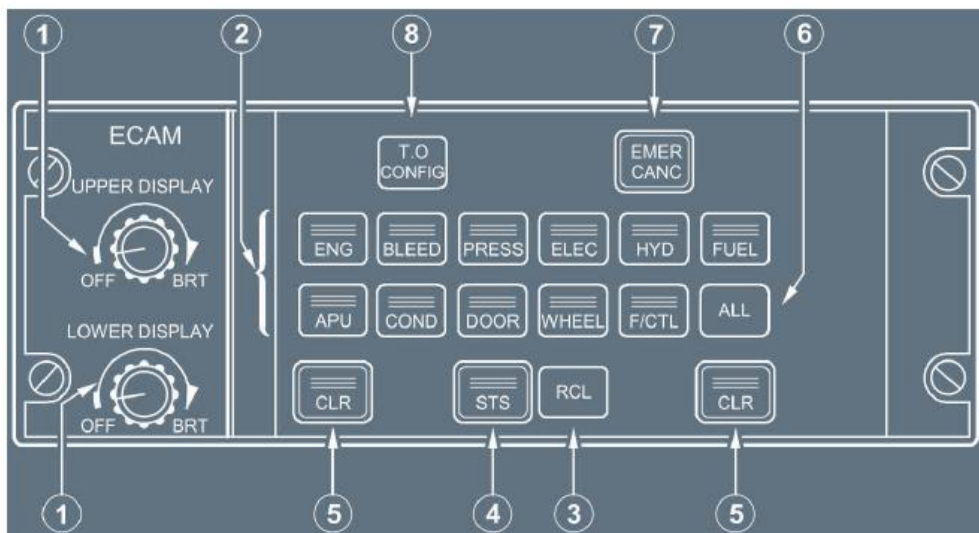

Figure 14: ECAM control panel

(5) *CLR pb* (Clear push button)

This pushbutton remains lit as long as the E/WD is displaying a warning or caution message, or a status message on the SD.

If it is lit, pressing it changes the ECAM display.

(7) *EMER CANC pb* (Emergency Cancel pushbutton)

This pushbutton affects the following:

- *Warnings:*
 - *Cancel (stop) an aural warning for as long as the failure condition continues*
 - *Extinguish the MASTER WARNING lights*
 - *Does not affect the ECAM message display.*
- *Caution*
 - *Cancel any present caution (single chime, MASTER CAUTION lights, ECAM message) for the rest of the flight*
 - *Automatically calls up the STATUS page, which displays “CANCELLED CAUTION” and the title of the failure that is inhibited.*

The inhibition is automatically suppressed when Flight Phase 1 is initiated. The pilot may restore it manually by pressing the RCL pb for more than 3 s.

Note: This pushbutton should only be used to suppress spurious MASTER CAUTIONS.

SPURIOUS CAUTION

Any spurious caution can be deleted with the EMER CANCEL pushbutton. When pressed, the EMER CANCEL pushbutton deletes both the aural alert, and the caution for the remainder of the flight. This is indicated on the STATUS page, by the "CANCELLED CAUTION" title.

The EMER CANCEL pushbutton inhibits any aural warning that is associated with a red warning, but does not affect the warning itself.

RCL (Recall) PUSHBUTTON

The RCL pushbutton allows to call up all ECAM alerts and the STATUS page that may have been suppressed by the CLR pushbutton or by the flight-phase-related inhibition.

Any alerts that have been inhibited by the EMER CANCEL pushbutton are displayed when the fly crew holds the RCL pushbutton down for more than three seconds.

The procedure on the QRH which include the operation of the EMER CANC pushbutton:

Note: - If the approach is flown at less than 750 ft RA, the “L/G NOT DOWN” warning will be triggered. The pilot can cancel the aural warning by pressing the EMER CANC pb, located on the ECAM control panel.

1.7 Meteorological Information

On the day of occurrence the weather report obtained from *Badan Meteorologi Klimatologi dan Geofisika* (BMKG – Bureau of Meteorology, Climatology and Geophysics) showed partial area of towering cumulonimbus clouds formation with the top of clouds approximate 24,000 feet up to 44,000 feet on the vicinity where the aircraft was flying.

The wind direction when the aircraft was flying mostly westerly with 15 – 20 kts, with the outside air temperature ranging from -56°C to -62°C (see the circles on the figure below).

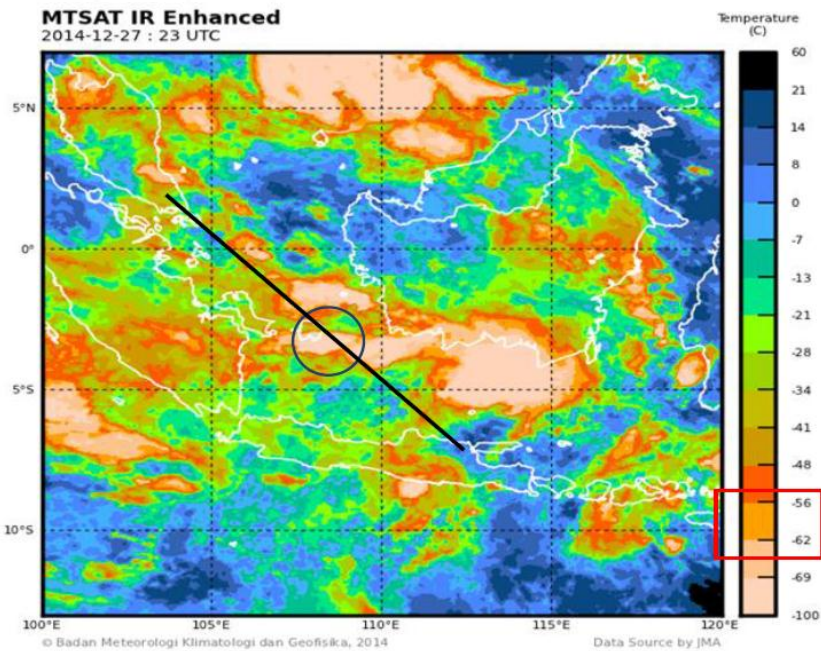

Figure 15: The BMKG satellite weather image at 2300 UTC

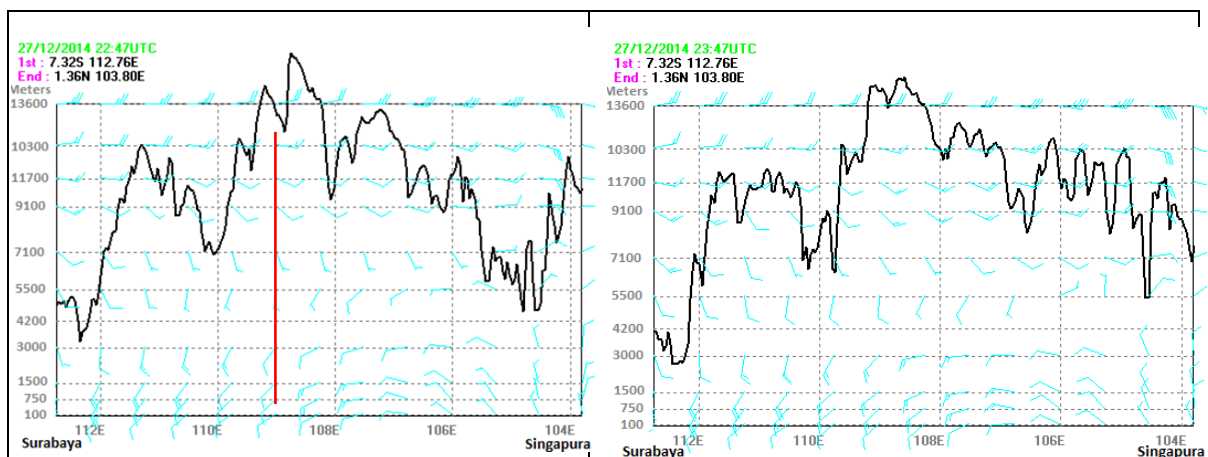

Figure 16: The cloud height (in meter) view along the airways of M635

1.8 Aids to Navigation

ADS-B (Automatic Dependent Surveillance – Broadcasting)

Automatic Dependent Surveillance – Broadcast (ADS-B) is a cooperative surveillance technology in which an aircraft determines its position via satellite navigation and periodically broadcasts it, enabling it to be tracked. The information can be received by air traffic control ground stations as a replacement for secondary radar. It can also be received by other aircraft to provide situational awareness and allow self-separation.

ADS-B is "automatic" in that it requires no pilot or external input. It is "dependent" in that it depends on data from the aircraft's navigation system.

ADS-B is an element of the US Next Generation Air Transportation System (Next Gen) and the Single European Sky ATM (-Air Traffic Management) Research (SESAR). ADS-B equipment is currently mandatory for Australian airspace. The United States requires an aircraft to be equipped with ADS-B capability by 2020 while in Europe from 2017. Canada already applied ADS-B for Air Traffic Services.

Indonesia has not mandated for ADS-B. However, in preparation to comply several transmitters have been installed in several places such as Jakarta, Semarang and Pangkalan Bun. The aircraft has capability of ADS-B.

Referring to the NOTAM (Notification to Airmen) available it showed that the navigation aids along the airway M635 are operative and in the normal condition (the NOTAM will be included on the final report).

Based on the Automatic Dependent Surveillance-Broadcast (ADS-B) data from the Air Traffic Control data superimposed to Google earth showed that the aircraft deviated to the left from the airway M635.

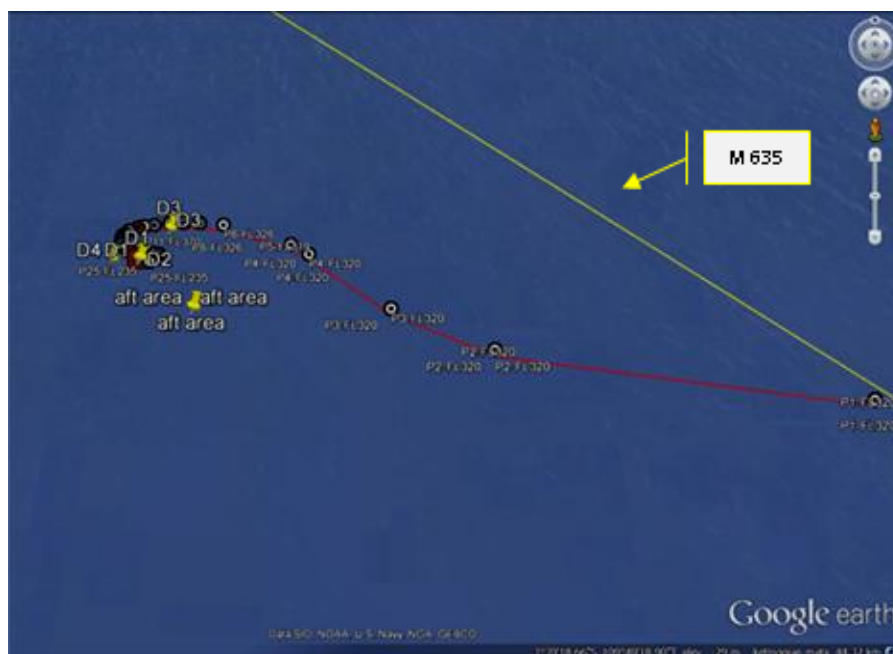

Figure 17: Automatic Dependent Surveillance – Broadcast (ADS-B) data superimposed to Google earth

The recorded ADS-B data were shown in the figure below.

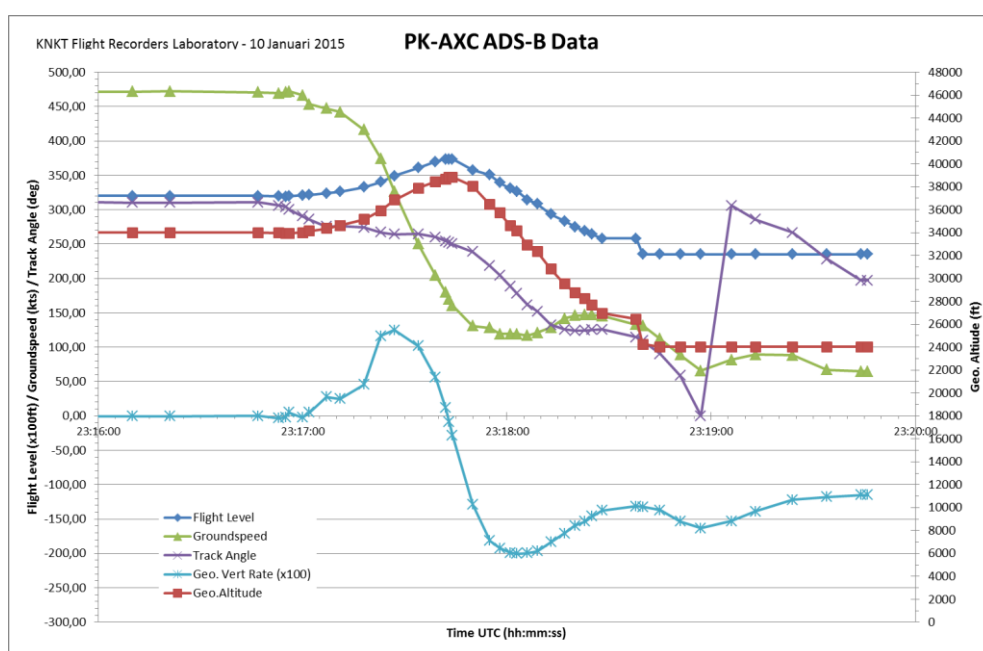

Figure 18: ADS-B data

1.9 Communications

All the communications between the pilot and the Air Traffic Services (Bali Upper Control, Ujung Pandang West Control and Jakarta Radar) were normal as recorded by the aircraft Cockpit Voice Recorder (CVR). The qualities of the recorded transmissions were good.

1.10 Aerodrome Information

The Juanda Airport, Surabaya and Changi International Airports Singapore did not have significant NOTAM or information and it is considered not relevant for this accident.

1.11 Flight Recorders

The aircraft was equipped with a Flight Data Recorder (FDR) and a Cockpit Voice Recorder (CVR) which were located in the tail section of the aircraft. Both recorders were detached from its rack and when recovered from the crash site.

The recorders were recovered by KNKT searching team assisted by China, France, Russia, Singapore, United Kingdom, and Indonesia Navy divers.

1.11.1 Flight Data Recorder

The Flight Data Recorder was recovered on 12 January 2015 and immediately transported to the KNKT recorder facility in Jakarta.

The recorders read-out was performed at KNKT recorder facility with the participation of the Australian Transport Safety Bureau (ATSB, Australia) and the Bureau d' Enquêtes et d' Analyses (BEA, France) as Accredited Representatives.

The FDR data were as follows:

Manufacturer : L-3 Communication
Type/Model : FA2100FDR
Part Number : 2100-4043-02
Serial Number : 000556583

The FDR recorded approximately 1200 parameters and about 174 hours of aircraft operation containing 74 flights including the accident flight.

It is noted that in some specific circumstances, some parameters alternations patterns could be recorded and observed on FDR Data. These specific FDR parameter patterns occur when a data to be recorded is not available at the FDR entry interface. This parameter unavailability could be due to the emitter equipment is set OFF, de-energized, wiring problem or other issue resulting in the information do not arrive at the FDR interface.

In such situation, for example for FDR binary recorded data, the alternative recording at one sample will record the minimum parameter value then, at the next sample will record the maximum parameter value and so on, indicate this parameter unavailability, as soon as the parameter is not refresh or not provided by the relevant equipment.

In particular, this situation was observed when the FAC 1 and the FAC 2 were de-energized during the accident flight.

The FDR data showed that while the aircraft was cruising at an altitude of 32,000 feet in normal condition, the aircraft then deviated to the left from airway M635. The master caution triggered by both RTLU problems activated 4 times. The fifth master caution was related to the FAC 1 FAULT activating. The sixth master caution was triggered by the FAC 1+2 FAULT and followed by the autopilot and auto-thrust disengaged and flight control law reverted from Normal Law to Alternate Law.

Subsequently the aircraft entered a steep turn and climb, eventually reaching high angle of attack, the stall warning activated and continued until the end of the recording. The FDR and CVR recording ended at 2320:35 UTC.

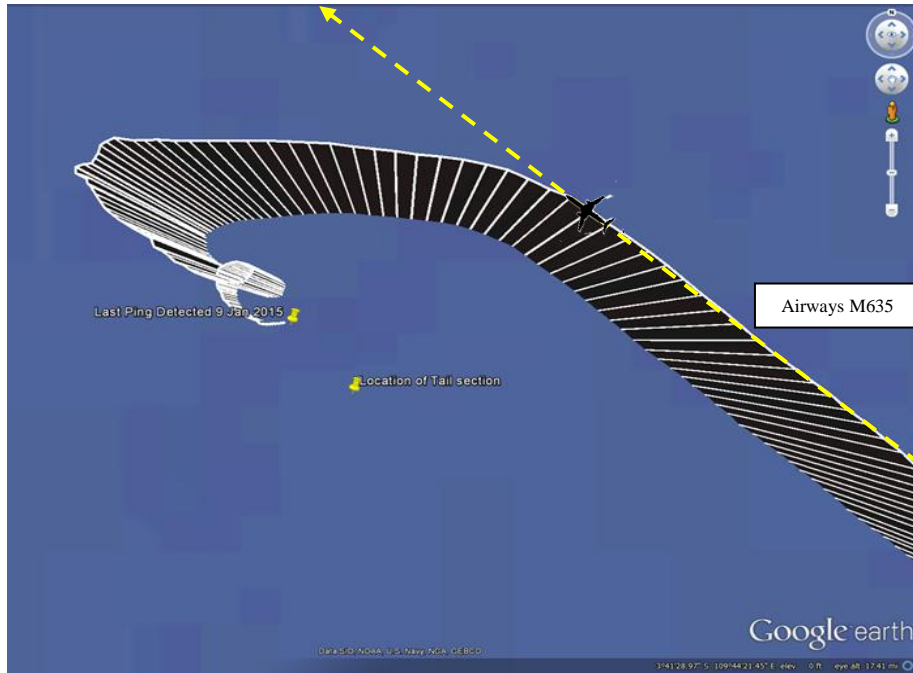

Figure 19: Flight path based on FDR data superimposed to the Google Earth

Detail information of the FDR is shown on the following graphs.

Note: abbreviation of FDR parameter indication available in the list of abbreviation of FDR parameters.

PK-AXC Airbus 320-216

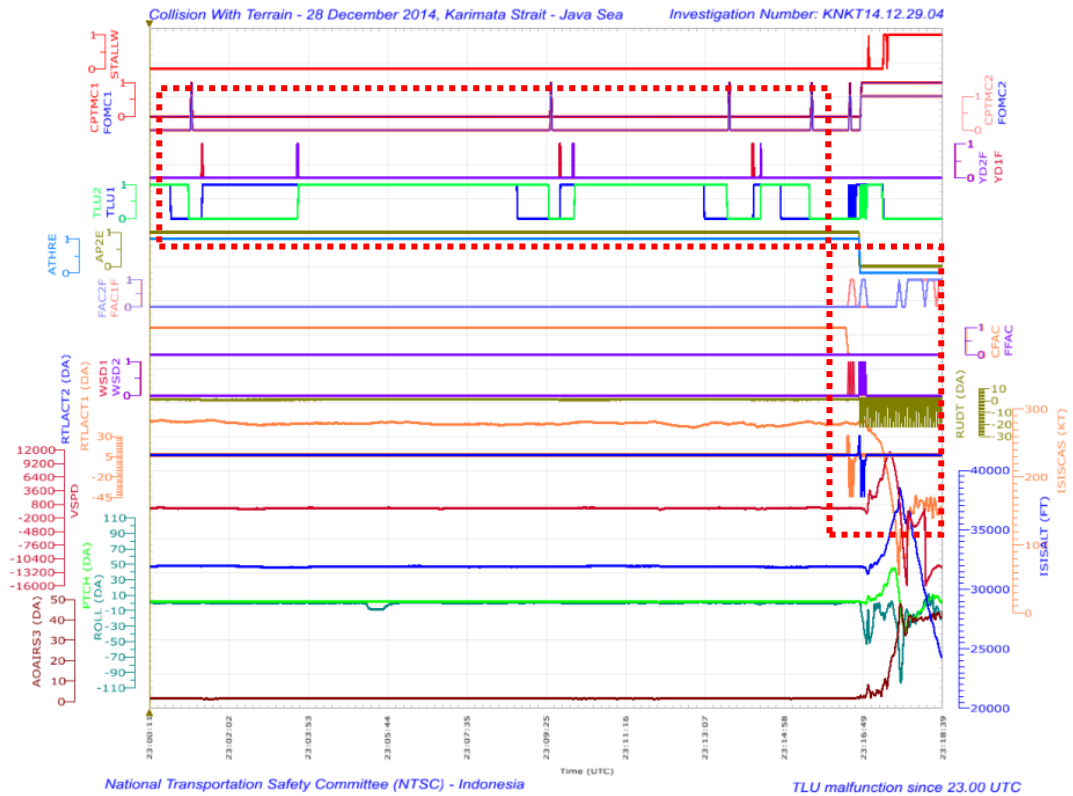

Figure 20: RTLU problems and pilot actions

The red box with the dash line on the graph shows:

Activation of the Master Caution (MC) associated with both RTLU malfunction.

- First at 2301:10 UTC,
- Second at 2309:32 UTC,
- Third at 2313:41 UTC,

All three MCs were followed by pilot action of pressing the FAC push buttons 1 and 2, these are indicated by a status change the Yaw Damper Fault (YDF) 1 and 2 parameters.

At 2315:36 UTC, the fourth Master Caution illuminated associated with both RTLU malfunction and was followed by different indication on FDR parameters.

The fifth Master Caution at 2316:28 UTC was triggered by FAC 1 FAULT.

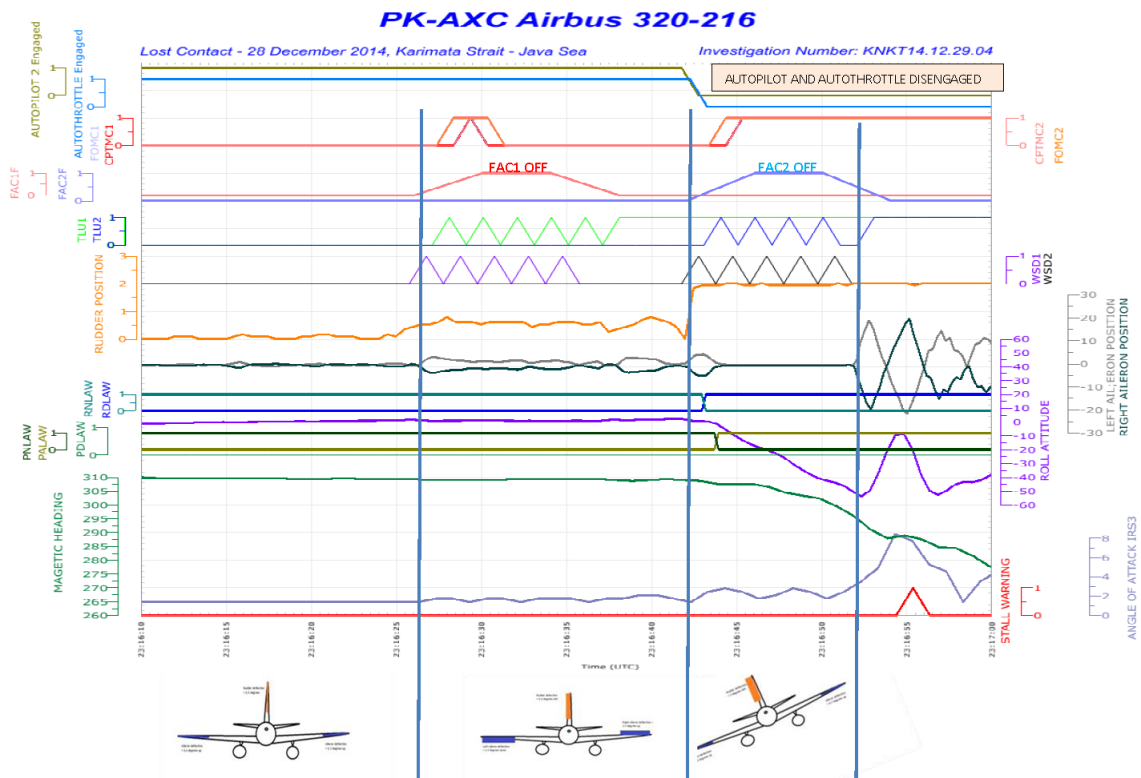

Figure 21: FDR parameters after the fifth Master Caution

The graph showed:

- At 2316:28 UTC: The fifth Master Caution was triggered by FAC 1 FAULT, and followed by fluctuation of parameters of component controlled by FAC 1 such as RTLU 1, Wind Shear Detection 1 and Rudder Travel Limiter Actuator 1. Rudder deflected 1° and ailerons were also deflected.
- At 2316:39 the FAC 1 was back to ON and all fluctuating parameters stopped.
- At 2316:44 UTC, the sixth Master Caution was triggered by FAC 1+2 FAULT and followed by:
 - o Fluctuation of parameters of component controlled by FAC 2 such as RTLU 2, Wind Shear Detection 2 and Rudder Travel Limiter Actuator 2
 - o The autopilot and auto-thrust disengaged
 - o Flight control law reverted from Normal Law to Alternate Law
 - o Rudder deflected 2° and aileron deflection 0°.
- The aircraft started to roll.
- At 2316:54 UTC the FAC 2 was back to ON and all fluctuating parameters stopped. The autopilot and auto thrust remained disengaged. Flight control law remained in Alternate Law.

PK-AXC Airbus 320-216

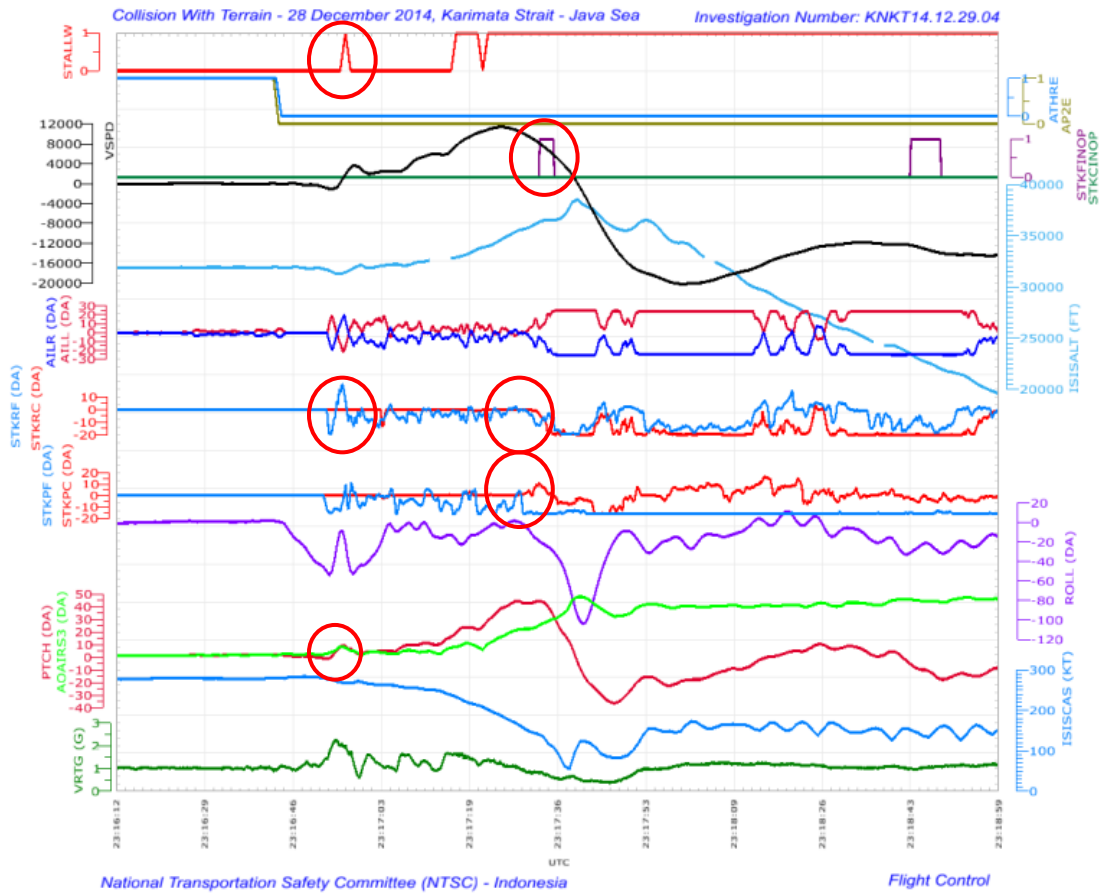

Figure 22: Pilots inputs on side stick

The FDR graphs for the Calibrated Airspeed (CAS) and Altitude (ALT) were taken from the Integrated Standby Instrument System (ISIS) and not the ADIRU1 which was the source of the left PFD, as the data from this source became unavailable from a certain time.

The FDR graph showed:

- At 2316:43 UTC, the autopilot and auto-thrust disengaged and the aircraft started to roll to the left up to 54°.
- At 2316:52 UTC, the first right side-stick input was recorded with pitch up input of 15° and one second latter roll input to the right 19° was recorded. The aircraft roll angle then decreased to 9° to the left.
- At 2316:55 UTC, the right side-stick input was to the left at maximum deflection and the aircraft rolled back to 53° to the left.
- At 2316:56 UTC, the pitch was at 9° up while the Angle of Attack (AOA) reached 8° and triggered the Stall Warning which immediately disappeared as the AOA decreased to below 8°.
- The input on the right side-stick was continuously pitching up and the aircraft climbed to approximately 38,000 feet with a rate of up to 11,000 feet per minute.

- At 2317:17 UTC, the stall warning activated when the aircraft altitude was passing 32,880 feet, stopped for 1 second at 2317:22 UTC and then continued until the end of recording.
- The first left side stick input was at 2317:03 UTC for 2 seconds, then 15 seconds later another input for 2 seconds, and at 2317:29 the input continued until the end of the recording.
- Since 2317:29 UTC, the right side stick input was constantly at maximum pitch up until the end of recording.
- At 2317:33 UTC the pitch recorded was at the highest value of 45° up. The left priority button was pressed for 2 seconds, and at 2318:43 was pressed again for 5 seconds.
- The pitch gradually increased and between 2317:28 UTC until 2317:33 UTC was constantly up at approximately 44°.
- At 2317:38 UTC the aircraft reached the lowest speed recorded of 55 knots. Afterward the recorded speed fluctuated between 100 and 170 knots until the end of recording.
- At 2317:39 UTC the AOA reached 44° up, afterward decreased and constantly at approximately 40° up while the pitch constantly at 1° up until the end of recording.
- At 2317:41 UTC the aircraft reached the highest altitude of 38,500 feet (ISIS) and largest roll angle at 104° to the left. The aircraft then descended with a rate up to 20,000 feet per minute momentarily afterward the rate of descent was recorded at average of 12,000 feet per minute until the end of recording.

PK-AXC Airbus 320-216

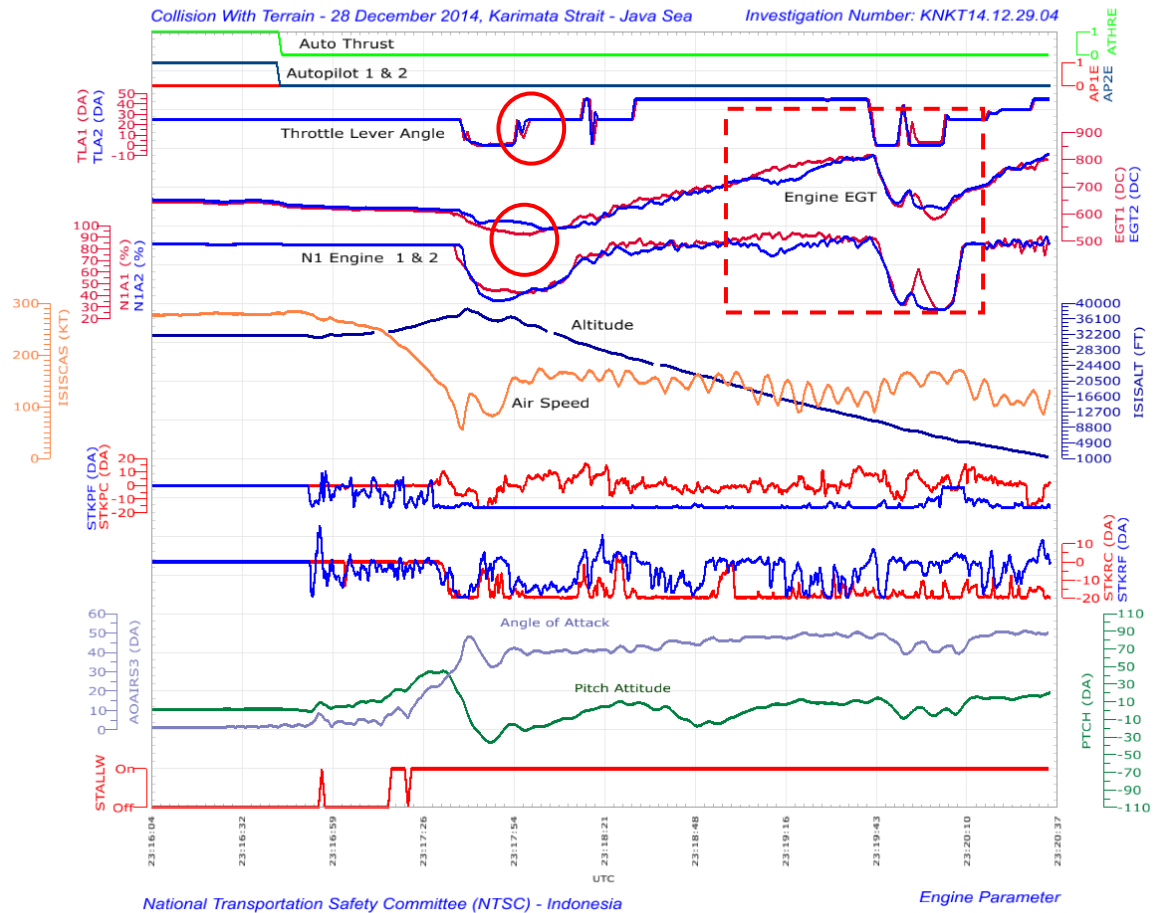

Figure 23: Thrust levers and side-sticks movement

The FDR graph showed:

- At 2317:39 UTC, the thrust levers angle retarded from 25° to 0° followed by decreasing of the Exhaust Gauge Temperature (EGT) and N1¹¹.
- At 2317:58 UTC, the thrust levers angle increased to 25° followed by increasing EGT and N1 and thereafter at 2318:31 UTC, the thrust lever angle increased to 44°, the N1 value remained relatively constant, while the EGT increased.

¹¹ N1 is the rotation speed of low pressure compressor (%).

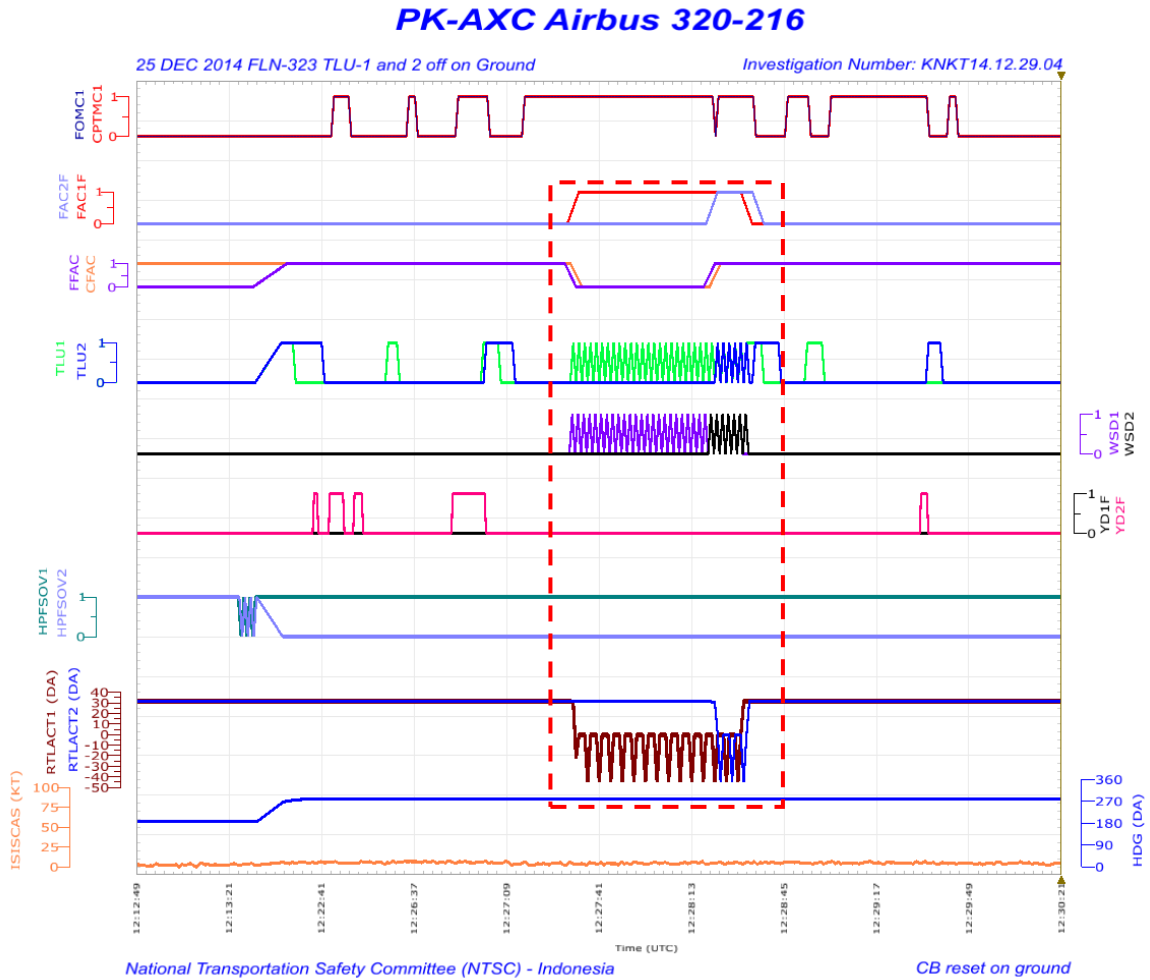

Figure 24: The FDR parameters of FAC fault followed by CB reset on the ground at 25 December 2014

The graph of the FDR data shown in figure above was the event where the FAC CBs were reset by the maintenance crew while the aircraft was on the ground on 25 December 2014. The red dash lined square shows the FAC OFF, and parameters of component controlled by FAC such as the Rudder Travel Limiter Unit (RTLU), Windshear Detection (WD) and Rudder Travel Actuator (RTLACT) fluctuated, affected by the FAC CB resetting.

1.11.2 Recorded system failure

The FDR contained data of the last 74 flights including the accident flight. The failure of the RTL unit and FAC recorded on the FDR were as follows:

Table of RTLU ECAM messages recorded on FDR on the 74 previous flights prior to the accident flight.

No	Date	Flight Number	Flight Sequence on the FDR	ECAM Message	Remarks
1.	19 Dec 2014	7684	15	RTL-1 and RTL-2 off	9 RTL fault cycles
		7689	16	RTL-1 and RTL-2 off	13 RTL fault cycles
2.	20 Dec 2014	7693	20	RTL-1 and RTL-2 off	RTL fault during descent
3.	21 Dec 2014	8501	34	RTL-1 and RTL-2 off	1 RTL fault cycle, 1 partial RTL fault cycle (YD1 reset)
4.	22 Dec 2014	7685	38	RTL-1 and RTL-2 off	1 RTL fault cycle partial reset (YD1 reset)
		7684	39	RTL-1 and RTL-2 off	Partial RTL fault (RTL1 failed for entire flight)
		7689	40	RTL-1 Off	RTL1 fault during taxi at the end of the flight
		7681	42	RTL-1 Off	RTL1 fault during approach, not reset until end of next flight
5.	23 Dec 2014	7680	43	RTL-1 Off	RTL1 fault present for entire flight
		387	47	RTL-1 and RTL-2 off	1 RTL fault cycle during climb and 1 RTL1 fault and reset during cruise
		7620	48	RTL-1 Off	RTL1 fault and reset during descent
6.	24 Dec 2014	323	53	RTL-1 Off	RTL1 fault during climb not reset for entire flight
7.	27 Dec 2014	7683	70	RTL-1 Off	RTL1 fault in descent RTL2 fault and master caution during taxi in
8.	28 Dec 2014		74	Accident flight	

PK-AXC Airbus 320-216

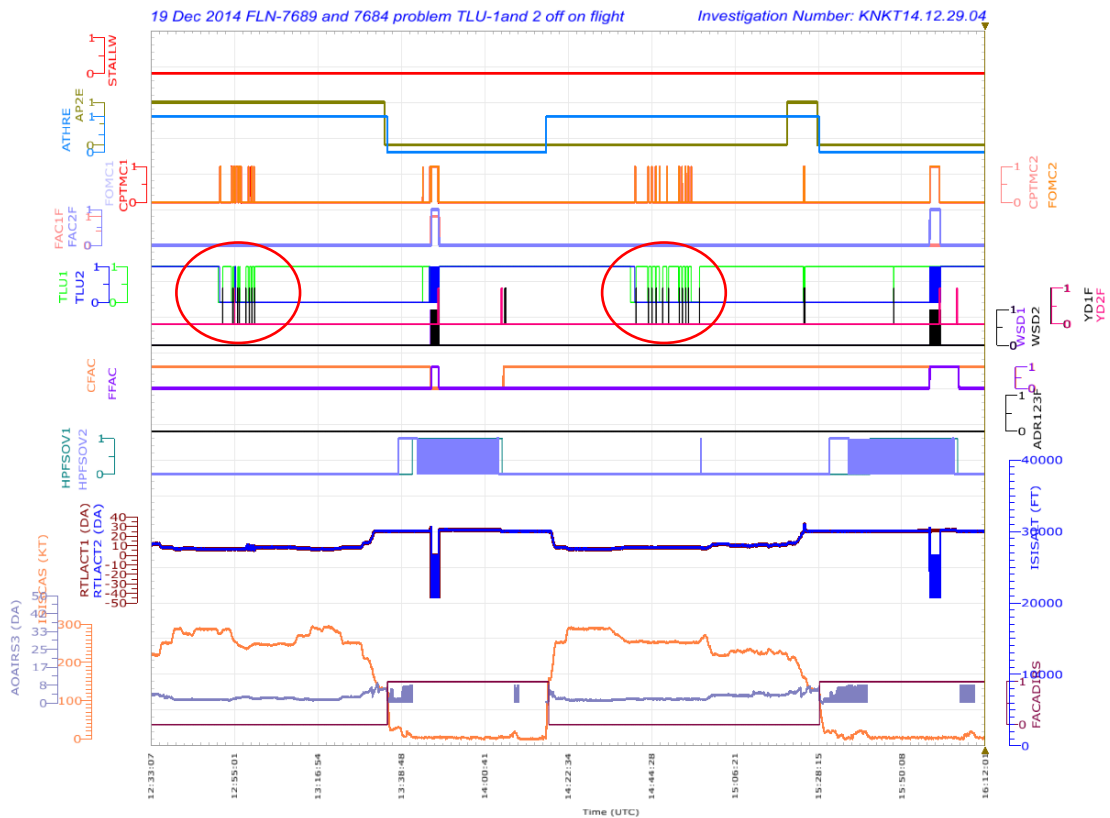

On the 19 December 2014, PK-AXC operated flights QZ7684, from Jakarta (Soekarno-Hatta) Airport to Surabaya Airport, and QZ7689 from Surabaya Airport to Jakarta (Soekarno-Hatta) Airport. During these two flights the RTLU system faulted twenty two times resulting in a master caution alert. Each RTLU fault was satisfactorily resolved by the crew using the ECAM FAC reset procedure.

Although the fault occurred multiple times, it did not follow any regular pattern or phase of flight. During flight QZ7684 the RTLU faults occurred during climb and initial cruise. However, during flight QZ7689 the faults occurred during cruise and descent, including two faults during the landing approach.

The aircraft defect reporting system logged the RTLU system faults as a single event, item 32 work order number 1931242. The defect report logged “AUTO FLIGHT RUD TRV LIM SYS” ECAM message. The MR1 showed that the PFR was checked and an operational check of the auto-flight system was performed. The operational check was satisfactory and the defect maintenance action was closed.

1.11.3 Cockpit Voice Recorder

The Cockpit Voice Recorder (CVR) was recovered on 13 January 2015 and immediately transported to KNKT recorder facility in Jakarta.

The CVR read-out was performed at KNKT recorder facility with the participation of the Australian Transport Safety Bureau (ATSB, Australia) and the Bureau d’Enquêtes et d’Analyses (BEA, France) as Accredited Representatives.

Manufacturer : L-3 Communication

Type/Model : FA2100CVR

Part Number : 2100-1020-02

Serial Number : 000539059

The CVR contained 2 hours and 4 minutes of good quality recording data. The significant excerpts from the CVR are as follow:

TIME (UTC)	FROM	TO	DESCRIPTION
2257:39	FA		Flight Attendant announcement to the passenger related to bad weather condition.
2304:59	PIC SIC		The pilot requested to deviate to the left of the track 15 miles. The SIC conducted cruise briefing.
2311:44	JKT RAD	QZ8501	Informing that the flight had been identified by Jakarta Radar and requested to the pilot to report when clear of the bad weather.
2311:49	QZ8501	JKT RAD	The pilot acknowledged and requested a higher cruising flight level
2311:55	JKT RAD	QZ8501	The Jakarta Radar controller asked about the pilot intended altitude
2312:01	QZ8501	JKT RAD	The pilot requested to climb to 38,000 feet
23:12:05	JKT RAD	QZ8501	The Jakarta Radar informed the pilot to standby for climb.
2313:40			The sound of single chime
2315:35			The sound of single chime
2315:35	JKT RAD		Provided clearance to climb to 340
2316:28			The sound of single chime
2316:30			The sound of single chime
2316:44			The sound of single chime
2316:46			The sound similar auto pilot off
2316:55			The sound of stall warning for 1 second
2317:03	PIC	SIC	“level...level...level” (repeated 4 times)
2317:15	PIC	SIC	“pull down... pull down..” (repeated 4 times).
2317:17			The sound of stall warning for 4 seconds

2317:23			The sound of stall warning until the end of recording.
2317:33	SIC		TOGA
2317:51	PIC	SIC	“Slowly...slowly....” repeated 5 times
2319:58	PIC	SIC	The PIC requested to select Display Management Computer to CAPT 3.
2320:36			<i>End of recording</i>

1.11.4 Selected significant events based on CVR and FDR

The following figures and table show significant events extracted from the FDR animation combined with the pilot conversation excerpt recorded on the CVR.

The events initiated when the autopilot (A/P) and auto-thrust (A/THR) disengaged, flight control on Alternate Law without several protections available as on Normal Law which occurred at 2316:43 UTC.

The speed information is available from two types of devices. The primary device type is the ADIRU (total 3 pieces) which is displayed on the PFDs. The other device type is the Integrated Standby Instrument System (ISIS) which will be displayed on the instrument when CAPT3 or FO3 selected.

Under normal functioning:

ISIS parameters are always displayed on ISIS display

ADIRU1 is displayed on PFD1

ADIRU2 is displayed on PFD2

To display the ADIRU3 parameters on PFD1 or PFD2 the crew has to use the Air Data Switching (CAPT on 3 or F/O on 3).

Note:

Sidestick Pitch (P) input Positive (+) value means nose down input

Sidestick Roll (R) input Positive (+) value means aircraft rolls to the left

Rudder Position Positive (+) means left rudder input (left yaw)

Elevator Position Positive (+) means TE down (nose-down)

Trimmable Stabilizer (THS) Position Range: -13.5° to +4° Positive: trailing edge (TE) up (nose-down)

Aileron Position Positive (+) means trailing edge (TE) down (nose up).



Conditions:

Speed (knots)	277 (ISIS)	282 (CAS)
Alt (feet)	31952	
Rudder	2°	
Roll	54°	
Pitch	-1.1°	
AOA	3.5°	
VS(fpm)	-1088	
N1	83%	
EGT	622 °C	
Sidesticks	PIC P: 0° R: 0°	SIC P: -15° R: +19

Figure 25: Aircraft rolled 54° to the left

Time (UTC)	From	To	Description
23:16:43	Warning		Auto pilot disengaged followed by cavalry charge (autopilot disengaged warning)
23:16:53	P1		“Oh my God”
23:16:54			The FAC 2 was re-energized
23:16:56	Warning		Stall warning activated for 1 second



Speed (Knots)	268 (ISIS)	272 (CAS)
Altitude (Feet)	31980 (ISIS)	33900 (GPS)
Rudder	2°	
Roll	19.7°	
Pitch	9.5°	
AOA	8°	
VS (fpm)	2624	
N1	83%	
EGT	621 °C	
Side-sticks	PIC P: 0° R: 0°	SIC P: 7° R: +10°

Figure 26: The first aural Stall warning activated

Time (UTC)	From	To	Description
2317:02	P1		Gave instruction “level...level...level...” (4 times)
2317:15	P1		Gave instruction “pull down...pull down” (2 times)

2317:17	Warning		Aural stall warning announced with cricket sound. Change of external airflow sound.
2317:22	P1	P2	Gave instruction “pull down...pull down” (3 times)

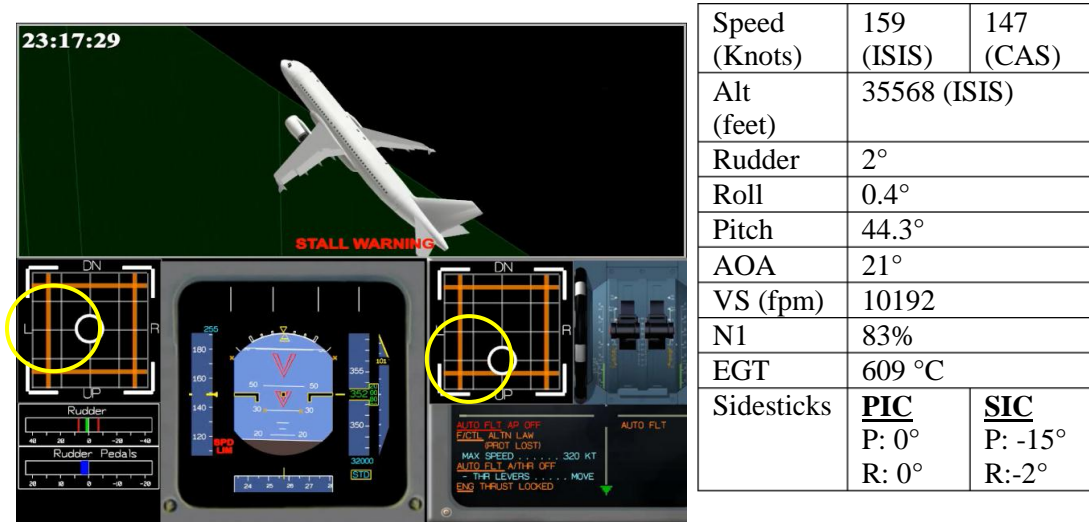

Figure 27: The aircraft attitude at the highest pitch angle

Time (UTC)	From	To	Description
2317:23	Warning		Aural stall warning activated with cricket sound and a sound similar to aircraft buffet continued until the end of recording.
2317:25	P1		Gave instruction “pull down...pull down”
2317:29	P2		<i>in French:</i> “What is going wrong”
			The left side stick input continued until the end of recording. Dual input on the side sticks continued until the end of recording.



Figure 28: Aircraft in upset¹³situation

Conditions:

Speed (knots)	118 (ISIS)	0 (CAS)
Alt (Feet)	37796 (ISIS)	
Rudder	-5°	
Roll	-104 °	
Pitch	-20.7°	
AOA	46°	
VS (fpm)	-4784	
N1	52%	
EGT	563 °C	
Sidesticks	PIC P: -4° R: -20°	SIC P: -16° R: -17°

Time (UTC)	From	To	Description
2317:41	P1		“My God.”



Figure 29: Attitude recovered

Conditions:

Speed (knots)	170 (ISIS)	37 (CAS)
Alt (feet)	28340	
Rudder	0°	
Roll	-2 °	
Pitch	0	
AOA	41.1°	
VS (fpm)	-15500	
N1	73 %	
EGT	589°C	
TLA	44.3	
Sidestick	PIC P: 15° R: 14°	SIC P: -16° R: -7°

¹³ Airplane Upset: An airplane in flight unintentionally exceeding the parameters normally experienced in line operations or training:

- Pitch attitude greater than 25 degree, nose up.
- Pitch attitude greater than 10 degree, nose down.
- Bank angle greater than 45 degree.
- Within the above parameters, but flying at airspeeds inappropriate for the conditions.

Time (UTC)	From	To	Description
2318:23	P1	P2	Instructed to “pull...pull”
2318:23	P1	P2	Instructed to “pull down...pull down”
2319:08	P1	P2	Instructed to “pull up” (2 times)
2319:10			Instructed to check the altitude (altitude recorded ISIS Altitude at 17,000)
2319:58	P1	P2	Instructed to select to CAPT 3.

1.12 Wreckage and Impact Information

In the first week of the search and rescue operation, the team recovered several aircraft parts floated at about 30 Nm southeast of the last aircraft known position on the ADS-B radar. The recovered parts were identified as:

- The left and right rear escape slides and the inflation bottles;
- The overhead cabin head rack which were attached to row 6 right;
- Passenger Services Unit (PSU) including of oxygen generators, lights and speakers.
- Two (2) sets of passenger seats identified as seat row 22 left and 17 right.

On 9 January 2015 the tail section was found submerged at the sea bed at approximately 30 meters depth at coordinate of 03°37'40" S; 109°42'75" E.

On 12 January 2015 the FDR was recovered at coordinate 03°37'22.2"S - 109°42'42.1"E followed by the CVR recovery at coordinate 03°37'18.1"S - 109°42'42.2"E on 13 January 2015.

On 13 January 2015 the major parts of the fuselage including both wings, main landing gears were identified on the sea bed at approximately 30 meters depth at coordinate 03°37'19.86"S - 109°42'42.36"E.

The tail section and fuselage were recovered and transferred to Kumai Harbour at Pangkalan Bun and afterward to Jakarta. The part sections recovered contain of vertical stabilizer and aft section of the fuselage up to section 73. The recorders were detached from its rack.

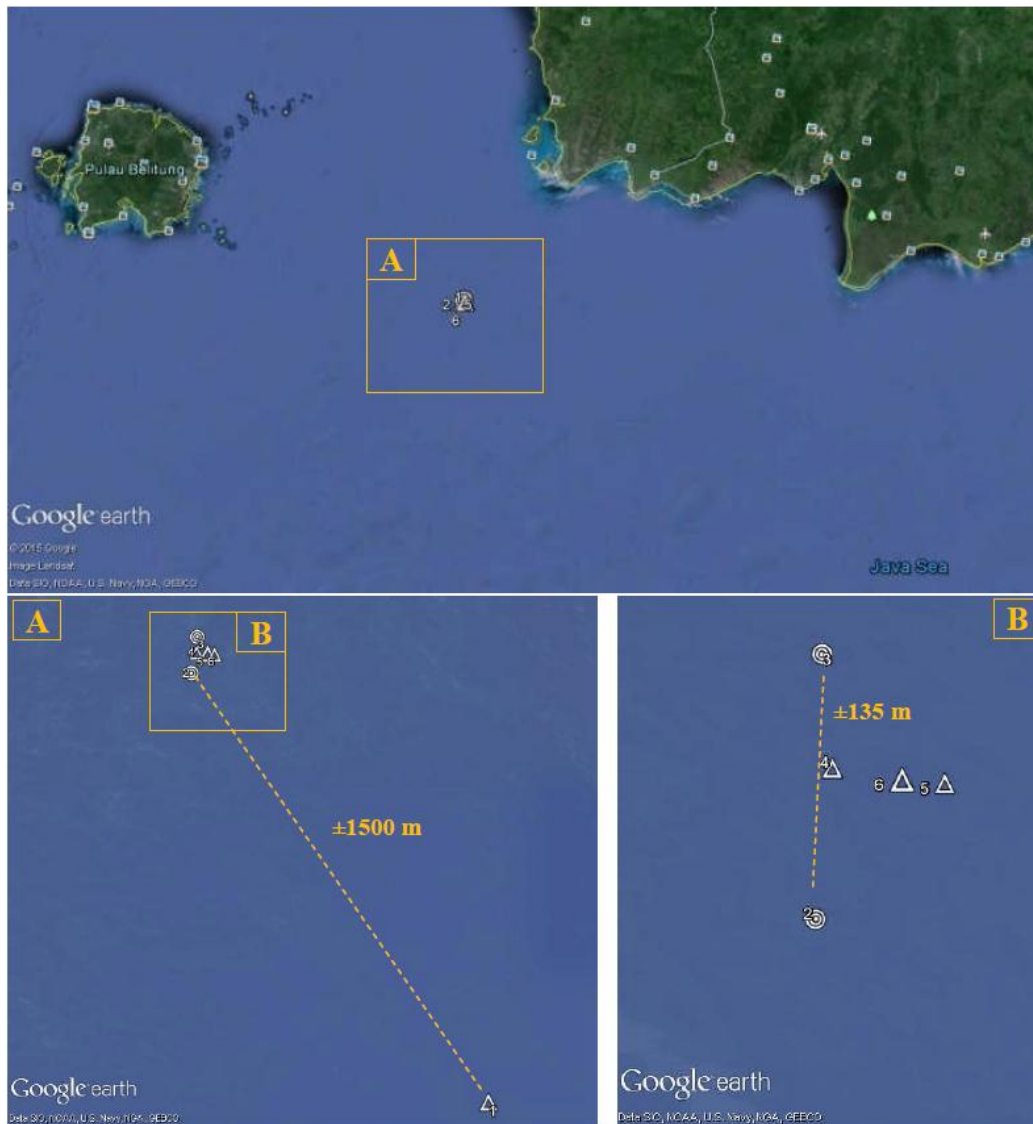

Figure 30: Wreckage Diagram superimposed on Google Map

The locations of the wreckage are as follows:

No	Description	Latitude	Longitude
1	Tail	3° 38' 1.70"S	109° 43' 10.47" E
2	FDR	3° 37' 22.2"S	109° 42' 42.1" E
3	CVR	3° 37' 18.1"S	109° 42' 42.2" E
4	Fuselage & Wing	3° 37' 19.86"S	109° 42' 42.36" E
5	One passenger seat	3° 37' 20.10"S	109° 42' 44.1" E
6	Engine	3° 37' 20.04"S	109° 42' 43.44" E

The distance between Tail to FDR and CVR was about 1500 m. The distance between FDR and CVR was about 135 m.

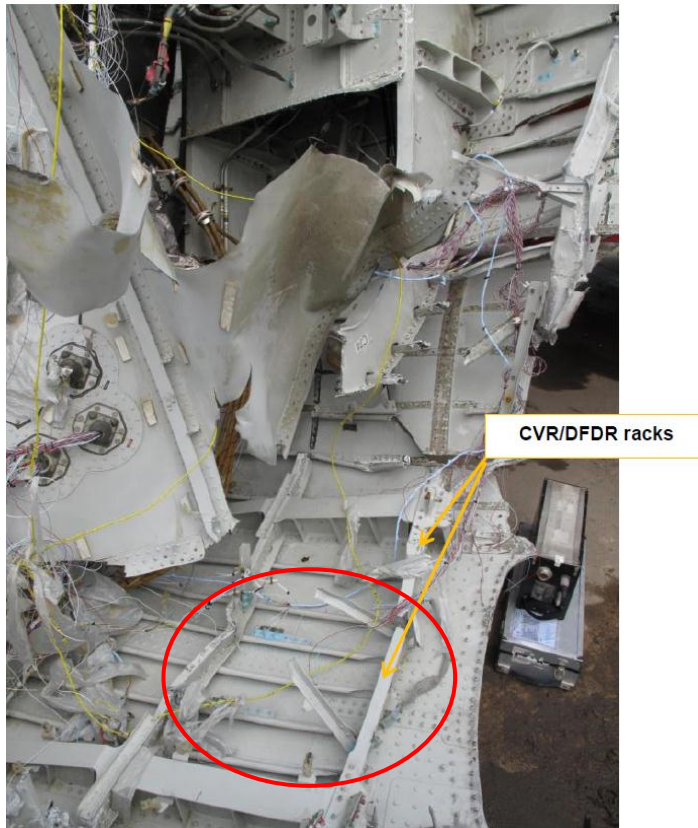

Figure 31: The FDR and CVR racks



Figure 32: Pictures of identified parts and its original position

1.13 Medical and Pathological Information

The total person on board were 162, included two pilots, four flight attendants and one company engineer. They were 79 male and 83 female; 22 of them were children under 15 years old.

Total recovered at the end of search operation were 116 bodies, 100 of them were identified and 16 could not be identified. The 100 identified bodies were 54 male and 46 female; consisted of 95 Indonesians, 1 France, 1 Malaysian, 2 South Koreans, and 1 United Kingdom.

1.14 Fire

There was no evidence of fire in-flight or after the aircraft impacted.

1.15 Survival Aspects

Level 1 alarm - INCERFA (Uncertainty Phase)

A situation where in uncertainty exists as to the safety of an aircraft and its occupants.

Whenever the time of last contact between an aircraft and ATC exceeds 30 minutes, or if an aircraft has not landed 30 minutes after the pilot has received landing clearance at an airfield and no other contact was established, a Level 1 Alarm internationally known as 'INCERFA' (Uncertainty Phase) is activated. The rescue coordination centre requests the flight plan of the particular aircraft via the FIC (Flight Information Centre), from which details such as aircraft type, registration, persons on board, route, alternate aerodrome or endurance can be taken.

Level 2 alarm - ALERFA (Alert Phase)

A situation where in apprehension exists as to the safety of an aircraft and its Occupants.

If initial investigations do not give any useful information about the position of the aircraft and if further investigations were unsuccessful, a Level 2 Alarm internationally known as 'ALERFA' (Alert Phase), is activated.

Level 3 alarm - DETRESFA (Distress Phase)

A situation where in there is reasonable certainty that an aircraft and its occupants are threatened by grave and imminent danger or require immediate assistance.

If the evaluation of further specific data (e.g. Radar Tracks, Flight plan details, etc.) does not give any adequate information confirming the position and/or safety of the distressed aircraft, a Level 3 Alarm, internationally known as 'DETRESFA' is activated. An extensive search procedure begins.

At 0008 UTC (0708 LT) Air Traffic Services Unit in Jakarta declared INCERFA and informed the situation to BASARNAS and KNKT.

At 0028 UTC (0728 LT) the status revised to ALERFA.

At 0055 UTC (0755 LT) the status revised to DISTRESFA.

Upon receiving the information about the loss contact of flight QZ 8501, BASARNAS initiated search and rescue (SAR) operation by collecting initial data.

At 28th December 2014 as the day of the accident, BASARNAS deployed aircraft to initiate search operation around Belitung Island and South West part of Kalimantan with three defined searching areas.

On the second day (29th December 2014), The SAR operation continued with additional four search areas which was centered to the last radar contact position, involving 14 aircrafts, 16 helicopters and 12 ships.

On 30 December 2014, the searching area was extended. Significant evidences of the aircraft were recovered at 30 nm south east of the last radar position which consisted of passenger luggage, deceased bodies and emergency escape slide. The searching operation moved to Pangkalan Bun.

The SAR operation continued under coordination of BASARNAS involving Indonesia Navy, Army, Police and other government and private agencies. Some other countries assisted for the SAR operation were Australia, China, Malaysia, Russia, Singapore, South Korea, and United States of America. The SAR operation involved 42 aircraft and 78 ships.

1.16 Tests and Research

1.16.1 Flight Simulation

KNKT performed 2 simulator exercises on Airbus A320 training simulator at STPI – Curug (*Sekolah Tinggi Penerbangan Indonesia – Indonesia Civil Aviation Institute*) and Air Asia Academy (AAA) training simulator in Kuala Lumpur.

The purposes of these simulations were to understand Airbus A320 systems and recreate the ECAM messages.

The scenario was by setting the RTLU malfunction and recorded the ECAM messages. Afterward, the pilot actions performed instructions displayed on the ECAM and recorded the result. In the simulation, the investigator also recreated the FAC CBs resetting and recorded the ECAM message result.

The ECAM displays on the simulator were as follows:



Figure 33: The page 1 and 2 of the ECAM messages after CBs of FAC 1 and 2 being reset

The ECAM displayed:

“AUTO FLT FAC 1+2 FAULT”,

“RUD WITH CARE ABV 160 KT”

“FAC 1..... OFF THEN ON”

“FAC 2..... OFF THEN ON”

As requested by ECAM action on page 2, following a FAC CB reset the FACs push button on overhead panel should be reset to OFF then ON to reactivate the functions.

The RTLTLU failure as recorded on the FDR could be recreated

- Similar ECAM messages to the data recorded on the FDR appeared when the FAC CBs were pulled.
- Dual input resulted in rapid movement of the aircraft compared to single input
- Dual input in different direction of the side-sticks reduced the ability to control the aircraft.
- The Emergency Cancel Button was effective to prevent pilot distraction for a repetitive malfunction.

As requested by the KNKT, BEA and Airbus performed the simulator session which referred to FDR data on the engineering simulator. The simulation intended to recreate ECAM messages appeared on the accident flight. The ECAM message during the RUD TRIM LIM SYS problem is presented in the following figure:



Figure 34: The ECAM messages after RTLTLU 1 and 2 fault

1.16.2 The RTLTLU examination

The RTLTLU which was recovered from the accident site was sent by KNKT to BEA for special inspection on behalf of KNKT. On 16 June 2015, the RTLTLU arrived at Artus Facilities with presence of BEA and Airbus.

The summary of the inspection report BEA2014-0058_tec03 is as follows:

The RTLTLU is composed of two main parts:

- A main case which includes the two motors and various other mechanical pieces
- An electronic module fixed by screws on the main case

The examination was carried out by performing visual and other inspection of the external part as well as the internal part, including the electronic modules of the RTLUs.

The channel A and channel B boards were visually examined under magnification at BEA.

The presence of cracks on solders was confirmed on the surface of both channels (Figure 35).

The summary of the examination found the electronic cards shows the evidence of cracking of soldering of both channel A and channel B. Those cracks could generate loss of electrical continuity and lead to a TLU failure.

Thermal cycles associated to powered/not-powered conditions and ground/flight conditions, generate fatigue phenomenon of the soldering, and may result in soldering cracking. Soldering cracking could induce a disconnection of components from the circuit. The disconnections could create a loss of the affected RTLUs channel.

The electronic module pictures are shown below.

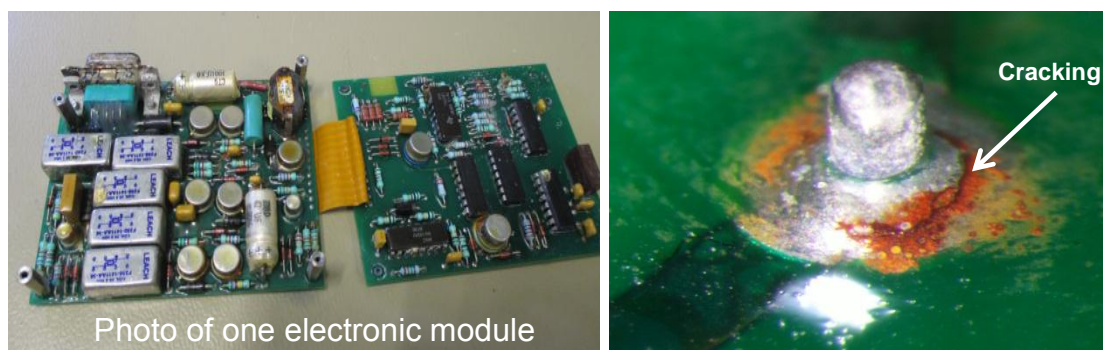

Figure 35: Electronic Module of RTLUs

According to the Airbus information, there were three Technical Follow-Ups (TFUs) regarding the AUTO FLT RUD TRV LIM 1(2) (SYS) problems that were issued since 1993. TFU No. 27.23.51.004 was opened in 1993 regarding the problem of fatigue rupture of solder and closed in 1996. The problem found was “fatigue rupture of soldering” and the improvement made was “new electronic module”.

Another TFU 27.23.00.004 was opened in 2000 with the same problem of “Rupture of soldering” and closed in 2014 with the improvement of the “Electronic board process” which was available since 2002. The third TFU (number 27.23.00.007) “Mechanical stop failure” was opened in January 2015 following this accident. Airbus informed that the installed RTLUs on PK-AXC had been improved with both Technical Follow-Ups (TFUs).

1.17 Organisation and Management Information

Aircraft Owner	:	Doric 10 Labuan Limited Company
Address	:	Unit Level 13 (E) Main Office Tower, Financial Park Labuan, Jl. Merdeka 87000 FT Labuan – Malaysia
Aircraft Operator	:	PT. Indonesia AirAsia
Address	:	Jl. Marsekal Suryadarma No. 1 Selapajang Jaya Neglasari Tangerang, Republic of Indonesia
Operator Certificate Number	:	AOC/121-009

Indonesia Air Asia is an airline based in Indonesia with several bases of operation which are Jakarta, Surabaya, Bali, Medan and Bandung. The airline operates domestic and regional routes with 30 Airbus A320 aircrafts including the accident aircraft. Indonesia Air Asia is a member of the Air Asia group.

1.17.1 Summary of Management Interview

During the interview with the Indonesia AirAsia management, one of the discussion topics was related to upset recovery training. The approved Operation Training Manual covers the upset recovery training in Chapter 8. The module consisted of ground and simulator training. The ground training provides the flight crew with the background, definition, cause of aircraft upset, aerodynamic and aircraft systems in relation with aircraft upset. Recovery methods consider various aircraft attitude and speed including post upset conditions.

The upset recovery training had not been implemented on Airbus A320 training, since it is not required according to the Flight Crew Training Manual and has not been mandated by the DGCA.

1.17.2 Summary of Maintenance Management Interview

The maintenance data of the Indonesia Air Asia such as maintenance manuals and handling repetitive problem had made the investigation to find similar issues on the sister company Malaysia AirAsia (MAA).

The agenda to visit MAA was to discuss the topics of the relationship between MAA and IAA in maintenance area, AD/SB management, and management of aircraft problem and rectified (including the repetitive trouble).

The engineering discussion was conducted between KNKT and MAA Engineering represented by MAA Technical Service Manager.

The summary of the discussions are as follows:

(a) The relationship of MAA and IAA

MAA and IAA Technical Service are the same level management with different regulatory basis. In term of corporation, basically MAA applied the centralized and decentralized system for the maintenance management to IAA.

The centralized management was applied to corporate policy such as spare part procurement.

The decentralized management was applied regarding the technical trouble management including the communication to the manufactures and vendors. The communication with the manufacturer also applied in flight operations.

The MAA provides the following services to IAA:

- Line Maintenance service as Approved Maintenance Organization (AMO).
- Provides technical data as Design Organization which covers class B with scope the major repair and major change.

The maintenance management was assisted by AMOS maintenance management application system. All the aircraft maintenance management and control are included in this system.

The similar application systems are also utilized by IAA. Design organization has not been established as it was not required by existing regulation.

Note: AMOS (Airline Maintenance and Operating Systems) is software for assisting the maintenance records and manual management.

(b) AD/SB Management and Controls

MAA manage the AD issued by EASA and FAA. MAA utilizes the AMOS and EASA Web to assist the AD/SB management. MAA also utilizes the Airbus Web for world Airbus operator to discuss the technical matter.

For any AD issued by EASA or FAA, MAA will conduct document assessment review before issuing the Engineering Instruction (EI). The EI will also be distributed to IAA for implementation. IAA will perform the assessment for the EI before it implements to comply with local regulators that may have different requirements.

If the AD requires SB implementation that has impact to safety, MAA will provide immediate documentation to implement including communication to operation department if the modification has not been performed due to part availability. (Note: IAA had a procedure to communicate with the operation department using the Notice to Crew (NTC)).

(c) Handling Repetitive Trouble

These troubles are normally addressed through the following methods:

- An automatic communication to transfer the PFR from air to ground by the system called "AIRMAN". This system utilizes the Aircraft VHF Communication to transfer any PFR issued by the CFDS from the aircraft to ground station or Maintenance Operation Centre (MOC). At the time of accident, IAA retrieved the PFR by manual downloading or printing out and collected to the MOC.
- WQAR (Wireless Quick Access Recorder) to expedite the collection of the aircraft limited for engine and APU only by utilizing the Flight Data

Recorder parameter during aircraft on the ground. Both MAA and IAA utilize this system, however, IAA had only implemented the system on PK-AXF and PK-AXR.

- MAA implements FDA (Flight Data Analysis) team to examine the trouble (including repetitive trouble) thoroughly by the expert personnel.
- Prognosis system that will be proposed for the next implementation by MAA.

If any repetitive trouble exists MAA collects information by all methods above and conducts detail analysis. The Trouble Shooting Manual (TSM) is the basic document to follow but in any circumstances, the sequence of TSM may be overridden to avoid circling without any solution including communication with the aircraft manufacturer to seek assistance.

1.17.3 Company Manuals

All Indonesia AirAsia company manuals have been approved by Indonesia Directorate General of Civil Aviation (DGCA). Relevant excerpts of the manuals are described in the following section.

1.17.3.1 Company Operation Manual (COM)

Crew Coordination during Emergencies or Abnormalities (chapter 4.10.1.7)

Emergency and abnormal Procedures are to be initiated on command of the Pilot Flying. The following assignment of tasks is recommended, provided the auto pilot operative.

<i>PF (Pilot flying) is responsible for :</i>	<i>PM (Pilot Monitoring) is responsible for :</i>
<ul style="list-style-type: none"> • <i>Throttles</i> • <i>Flight path and airspeed</i> • <i>Aircraft configuration</i> • <i>Navigation</i> • <i>Communication</i> 	<ul style="list-style-type: none"> • <i>Checklist reading</i> • <i>Execution of required actions on PF Request</i> • <i>Engine fuel levers, fire handles and guarded switches or any irreversible actions/systems, with confirmation</i>

The Pilot in Command may change over the control at any time to ensure that the highest level of safety is maintained.

Malfunction of flaps, which required approach and landing with zero degrees flaps setting shall be flown by the Pilot in Command. The approach and landing following other emergency or abnormal situations shall be conducted such that highest level of safety is achieved.

Following an in-flight emergency or abnormal situation, all approach either instrument or visual should not be commenced or should be discontinued, until the Emergency Memory Items procedures or such action would increase the potential risk have been completed. For more detail see AFM/FCOM.

During an emergency or abnormal situation, the Pilot in Command must allocate

crew duties to ensure that the highest level of situation awareness is maintained in the cockpit and cabin. This will prevent all attention being totally directed at resolving the emergency or abnormal situation to the detriment of safe flight. Any ambiguities, confusion, unresolved discrepancies or use of improper procedures must be discussed immediately, and if necessary a missed approach initiated to allow remedial action at safe altitude

Crew Resources Management (CRM)

Task Sharing and Duties Allocation

Air Asia does not practice full role reversal in its operations. With reference Normal Procedures (NP) of the QRH, during the Before Start, Engine Start, After Start, Taxi, Before Takeoff, After Landing and Parking phases, the duties ascribed to the PF are CM1, and the duties ascribed to the PNF is CM2. Exceptions to the rule, if any are specified in this document and that section of the QRH. CM1 is the flight crew seated on the LHS. CM2 is the flight crew seated on the RHS. Although in flight procedures in this chapter reflect duties for PF and PNF, the PIC retains final authority and responsibility for all actions directed and performed.

Crew Resource Management

CRM is the effective utilization of all available resources, e.g. crew (both flight crew and flight attendant), aircraft systems, and supporting facilities, to achieve safe and efficient flight operations.

CRM is not just the domain of the PIC. It is designed to raise each crew's awareness and skill in coping with a wide variety of operational situations and problems.

CRM demands that when necessary, the PIC should assign the aircraft control to the Co-pilot make maximum use of the auto-flight system and thereby retain sufficient capacity to manage events successfully.

These principles will form an integral element of the Air Asia Operating Policy and Task sharing duties. These collectively form the Standard Operating Procedures.

1.17.3.2 FCOM - Normal Checklist

Normal C/L are initiated by the PF and read by the PNF.

The PF shall respond after having checked the existing configuration. When both pilots have to respond, "BOTH" is indicated.

DEFINITIONS OF WARNINGS, CAUTIONS AND NOTES

The following are the official definitions of warnings, cautions and notes taken directly from the JAR25/CS-25 and applicable to Airbus flight operation documentation:

WARNING: *An operating procedure, technique, etc. that may result in personal injury or loss of life if not followed.*

CAUTION: An operating procedure, technique, etc. that may result in damage to equipment if not followed.

NOTE: An operating procedure, technique, etc. considered essential to emphasize. Information contained in notes may also be safety related.

1.17.3.3 FCOM - Auto Flight Rudder Limiter System

 A318/A319/A320/A321 FLIGHT CREW OPERATING MANUAL	PROCEDURES ABNORMAL AND EMERGENCY PROCEDURES AUTO FLIGHT
--	--

AUTO FLT RUD TRV LIM 1(2) (Cont'd)

Ident.: PRO-ABN-22-E-00010454.0001001 / 05 AUG 10	
STATUS	INOP SYS RUD TRV LIM 1(2)

AUTO FLT RUD TRV LIM SYS

Applicable to: MSN 2425-3477, 3489-3536, 3576-3628, 3679-3701, 3729, 3776, 3963-4019, 4070-4126, 4263-4302, 4361-4386, 4404, 4458, 4477-6550

Ident.: PRO-ABN-22-F-00010455.0008001 / 05 AUG 10

RUD WITH CARE ABV 160 KT

L2 Depending on when the failure occurs, the rudder travel limiter system may not be in the correct position for the flight speed. Therefore, to prevent damage to the aircraft structure, use the rudder with care, when the speed is greater than 160 kt.
 At slats' extension, full rudder travel authority can be recovered.

L1 FAC 1..... OFF THEN ON
 FAC 2..... OFF THEN ON

● If TLU (rudder or pedals) remains locked at high speed after slat extension:
 MAX X WIND FOR LDG 15 KT
 AUTO BRK..... DO NOT USE

L2 Do not use the autobrake, so as not to delay the application of differential braking at landing roll.

L1 ● AT LDG ROLL:
 DIFF BRAKING..... AS RQRD

Continued on the following page

 A318/A319/A320/A321 FLIGHT CREW OPERATING MANUAL	PROCEDURES ABNORMAL AND EMERGENCY PROCEDURES AUTO FLIGHT
--	--

AUTO FLT RUD TRV LIM SYS (Cont'd)

Ident.: PRO-ABN-22-F-00010456.0018001 / 27 MAY 13

L12

<p>RUD WITH CARE ABV 160 KT</p> <ul style="list-style-type: none"> ● If TLU (rudder or pedals) remains locked at high speed after slat extension: MAX X WIND FOR LDG 15 KT AUTO BRK..... DO NOT USE <i>Do not use the autobrake, so as not to delay the application of differential braking at landing roll.</i> ● AT LDG ROLL: DIFF BRAKING..... AS RQRD <p><i>Note:</i> An autoland must not be performed with a crosswind greater than 12 kt.</p>	<p>STATUS</p> <p><u>INOP SYS</u></p> <p>RUD TRV LIM</p>
--	---

AUTO FLT RUD TRV LIM SYS

Applicable to: MSN 3486, 3549, 3648, 3715, 3765, 3813-3875, 4035, 4147, 4333-4346, 4390, 4426, 4462

Ident.: PRO-ABN-22-F-00010455.0003001 / 05 AUG 10

RUD WITH CARE ABV 160 KT

L2 Depending on when the failure occurs, the rudder travel limiter system may not be in the correct position for the flight speed. Therefore, to prevent damage to the aircraft structure, use the rudder with care, when the speed is greater than 160 kt.
At slats' extension, full rudder travel authority can be recovered.

L1 FAC 1..... OFF THEN ON
 FAC 2..... OFF THEN ON

- AT LDG ROLL:
 DIFF BRAKING..... AS RQRD

Continued on the following page

1.17.3.4 Flight Crew Training Manual (FCTM)

FAILURE LEVELS (Operational Philosophy, ECAM)

The ECAM has three levels of warnings and cautions. Each level is based on the associated operational consequence(s) of the failure. Failures will appear in a specific color, according to a defined color-coding system, that advises the flight crew of the urgency of a situation in an instinctive, unambiguous manner. In addition, Level 2 and 3 failures are accompanied by a specific aural warning: A Continuous Repetitive Chime (CRC) indicates a Level 3 failure, and a Single Chime (SC) indicates a Level 2 failure.

Failure Level	Priority	Color Coding	Aural Warning	Recommended Crew Action
<i>Level 3</i>	<i>Safety</i>	<i>Red</i>	<i>CRC</i>	<i>Immediate</i>
<i>Level 2</i>	<i>Abnormal</i>	<i>Amber</i>	<i>SC</i>	<i>Awareness, then action</i>
<i>Level 1</i>	<i>Degradation</i>	<i>Amber</i>	<i>None</i>	<i>Awareness, then Monitoring</i>

When there are several failures, the FWC displays them on the Engine Warning Display (E/WD) in an order of priority, determined by the severity of the operational consequences. This ensures that the flight crew sees the most important failures first.

FEEDBACK

The ECAM provides the flight crew with feedback, after action is taken on affected controls:

- **The System Synoptic:**
Displays the status change of affected components.
- **The Memo:**
Displays the status of a number of systems selected by the flight crew (e.g. anti-ice).
- **The Procedures:**
When the flight crew performs a required action on the cockpit panel, the ECAM usually clears the applicable line of the checklist (except for some systems or actions, for which feedback is not available).

The ECAM reacts to both failures and pilot action.

ECAM HANDLING

ABNORMAL OPERATIONS

TASK SHARING RULES

When the ECAM displays a warning or a caution, the first priority is to ensure that a safe flight path is maintained. The successful outcome of any ECAM procedure depends on: Correct reading and application of the procedure, effective task sharing, and conscious monitoring and crosschecking.

It is important to remember that, after ECAM ACTIONS announcement by the PF:

- The PF's task is to fly the aircraft, navigate, and communicate.
- The PNF's task is to manage the failure, on PF command.

The PF usually remains the PF for the entire flight, unless the Captain decides to take control. The PF will then control the aircraft's flight path, speed, configuration, and engines. The PF will also manage navigation and communication, and initiate the ECAM actions to be performed by the PNF, and check that the actions are completed correctly.

The PNF has a considerable workload: Managing ECAM actions and assisting the PF on request. The PNF reads the ECAM and checklist, performs ECAM

actions on PF command, requests PF confirmation to clear actions, and performs actions required by the PF. The PNF never touches the thrust levers, even if requested by the ECAM.

Some selectors or pushbuttons (including the ENG MASTER switch, FIRE pushbutton, IR, IDG and, in general, all guarded switches) must be crosschecked by both the PF and PNF (except on ground), before they are moved or selected, to prevent the flight crew from inadvertently performing irreversible actions. As a general rule, any computer reset must be also crosschecked by both the PF and PNF.

To avoid mistakes in identifying the switches, Airbus' overhead panels are designed to be uncluttered. When the ECAM requires action on overhead panel pushbuttons or switches, the correct system panel can be identified by referring to the white name of the system on the side of each panel. Before performing any action, the PNF should keep this sequence in mind:

"System, then procedure/selector, then action" (e.g. "air, cross-bleed, close"). This approach, and announcing an intended selection before action, enables the PNF to keep the PF aware of the progress of the procedure.

It is important to remember that, if a system fails, the associated FAULT light on the system pushbutton (located on the overhead panel) will come on in amber, and enable correct identification.

When selecting a system switch or pushbutton, the PNF should check the SD to verify that the selected action has occurred (e.g. closing the cross-bleed valve should change the indications that appear on the SD).

Crew Coordination

PF	PNF
First pilot who notices: MASTER CAUTION/MASTER WARNING... RESET ANNOUNCE "TITLE OF FAILURE"	
FLY THE AIRCRAFT	
ORDER ECAM ACTIONS (2)	ECAM CONFIRM (1)
(3) ECAM ACTIONS COMPLETE .. CHECK CONFIRM CLEAR	ECAM ACTIONS / OEB .. PERFORM REQUEST .. CLEAR "name of SYS"? ECAM CLEAR
(4) CONFIRM CLEAR	SYSTEM PAGE ANALYSE REQUEST .. CLEAR "name of SYS"? SYSTEM DISPLAY CLEAR
CONFIRM STATUS (5) CONFIRM REMOVE STATUS	ANNOUNCE STATUS? STATUS READ REQUEST REMOVE STATUS? STATUS REMOVE (6) ANNOUNCE ECAM ACTIONS COMPLETED
SITUATION ASSESSMENT/DECISION	

1. The PNF should review the overhead panel and/or associated SD to analyze and confirm the failure, prior to taking any action, and should bear in mind

*that the sensors used for the SD may be different from the sensors that trigger the failure. The flight crew must always rely on the **CAB PR EXCESS CAB ALT** warning, even if not confirmed on the CAB PRESS SD page, as the warning can be triggered by a cabin pressure sensor different from the one used to control the pressure and display the cabin altitude on the SD page.*

- 2. In case of a failure during takeoff or go-around, ECAM actions should be delayed until the aircraft reaches approximately 400 ft, and is stabilized on a safe trajectory. This is an appropriate compromise between stabilizing the aircraft and delaying action.*
- 3. When the ECAM displays several failures, the sequence (action, then request and confirmation, before clearance) should be repeated for each failure. When all necessary actions are completed, amber messages and red titles will no longer appear on the E/WD.*
- 4. When the ECAM displays several system pages, the sequence (request and confirmation before clearance) should be repeated for each system page.*
- 5. The PF may call out "STOP ECAM" at any time, if other specific actions must be performed (normal C/L, or performing a computer reset). When the action is completed, the PF must callout: "CONTINUE ECAM".*
- 6. When slats are extended, the SD automatically displays the STATUS, unless if the page is empty. The STS should be carefully reviewed, and the required procedure applied.*
- 7. When ECAM actions have been completed, and the ECAM status has been reviewed, the PNF may refer to the FCOM procedure for supplementary information, if time permits. However, in critical situations the flight should not be prolonged only to consult the FCOM.*

IF THE ECAM WARNING (OR CAUTION) DISAPPEARS WHILE APPLYING THE PROCEDURE

If an ECAM warning disappears, while a procedure is being applied, the warning can be considered no longer applicable. Application of the procedure can be stopped. For example, during the application of an engine fire procedure, if the fire is successfully extinguished with the first fire extinguisher bottle, the ENG FIRE warning disappears, and the procedure no longer applies. Any remaining ECAM procedures should be performed as usual.

STALL RECOVERY

Definition of the Stall

The stall is a condition in aerodynamics where the Angle of Attack (AOA) increases beyond a point such that the lift begins to decrease.

As per basic aerodynamic rules, the lift coefficient (CL) increases linearly with the AOA up to a point where the airflow starts to separate from the upper surface of the wing. At and beyond this point, the flight crew may observe:

- Buffeting, which depends on the slats/flaps configuration and increases at high altitude due to the high Mach number
- Pitch up effect, mainly for swept wings and aft CG. This effect further increases the AOA.

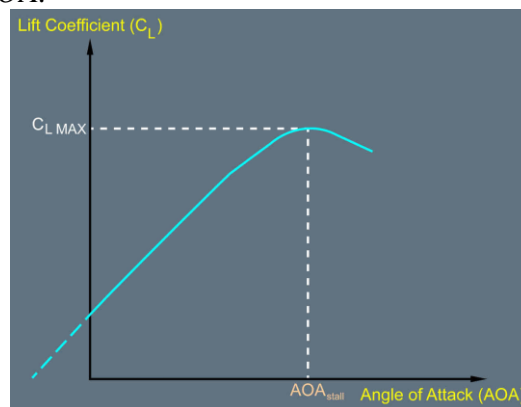

Lift Coefficient versus Angle of Attack.

If the AOA further increases up to a value called AOA_{stall} , the lift coefficient will reach a maximum value called $C_{L\text{ MAX}}$.

When the AOA is higher than AOA_{stall} , the airflow separates from the wing surface and the lift Coefficient decreases. This is the stall.

The stall will always occur at the same AOA for a given configuration, Mach number and altitude.

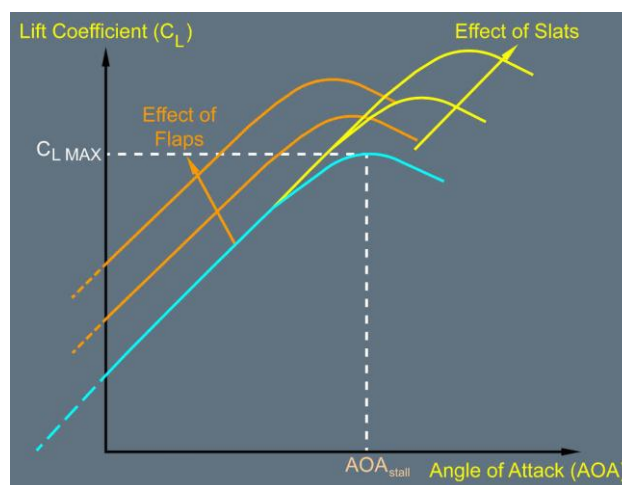

Influence of Slats and Flaps on Lift Coefficient versus Angle of Attack, Slats and Flaps have a different impact on the Lift coefficient obtained for a given AOA. Both Slats and Flaps create an increase in the maximum lift coefficient. Influence of Speed Brakes and Icing on Lift Coefficient versus Angle of Attack.

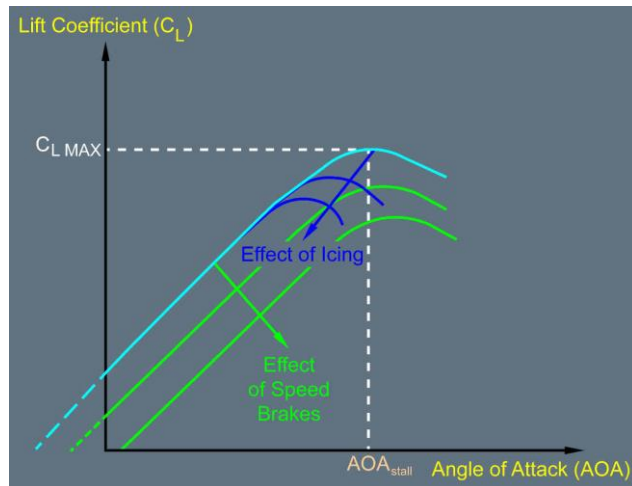

On the contrary, speed brake extension and ice accretion reduce the maximum lift coefficient.

Flight control laws and stall warning threshold take into account these possible degradations.

To summarize, loss of lift is only dependant on AOA. The AOA_{stall} depends on:

- Aircraft configuration (slats, flaps, speed brakes)
- Mach and altitude
- Wing contamination

Stall Recognition

The flight crew must apply the stall recovery procedure as soon as they recognize any of the following stall indications:

- Aural stall warning

The aural stall warning is designed to sound when AOA exceeds a given threshold, which depends on the aircraft configuration. This warning provides sufficient margin to alert the flight crew in advance of the actual stall even with contaminated wings.

- Stall buffet

Buffet is recognized by airframe vibrations that are caused by the non-stationary airflow separation from the wing surface when approaching AOA_{stall} .

When the Mach number increases, both the AOA_{stall} and CL_{MAX} will decrease. The aural stall warning is set close to AOA at which the buffet starts. For some Mach numbers the buffet may appear just before the aural stall warning.

Stall Recovery

- The immediate key action is to reduce AOA:

The reduction of AOA will enable the wing to regain lift. This must be achieved by applying a nose down pitch order on the side-stick. This pilot action ensures an immediate aircraft response and reduction of the AOA.

In case of lack of pitch down authority, it may be necessary to reduce thrust. Simultaneously, the flight crew must ensure that the wings are level in order to reduce the lift necessary for the flight, and as a consequence, the required AOA.

As a general rule, minimizing the loss of altitude is secondary to the reduction of the AOA as the first priority is to regain lift.

As AOA reduces below the AOA_{stall} , lift and drag will return to their normal values.

- The secondary action is to increase energy:

When stall indications have stopped, the flight crew should increase thrust smoothly as needed and must ensure that the speed brakes are retracted.

Immediate maximum thrust application upon stall recognition is not appropriate. Due to the engine spool up time, the aircraft speed increase that results from thrust increase, is slow and does not enable to reduce the AOA instantaneously.

Furthermore, for under wing mounted engines, the thrust increase generates a pitch up that may prevent the required reduction of AOA.

When stall indications have stopped, and when the aircraft has recovered sufficient energy, the flight crew can smoothly recover the initial flight path. If in clean configuration and below FL 200, during flight path recovery, the flight crew must select FLAPS 1 in order to increase the margin to AOA_{stall} .

Stall Warning at Lift-Off

At lift-off, a damaged AOA probe may cause a stall warning to spuriously sound in the cockpit. If the aural stall warning sounds at liftoff, the flight crew must fly the appropriate thrust and pitch for takeoff in order to attempt to stop the aural stall warning and ensure a safe flight path.

The flight crew applies TOGA thrust in order to get the maximum available thrust. Simultaneously, the pilot flying must target a pitch angle of 15 ° and keep the wings level in order to ensure safe climb.

Then, when a safe flight path and speed are achieved, if the aural stall warning is still activated the flight crew must consider that it is a spurious warning.

1.17.3.5 FCTM - Abnormal Attitudes

If the aircraft is, for any reason, far outside the normal flight envelope and reaches an abnormal attitude, the normal controls are modified and provide the PF with maximum efficiency in regaining normal attitudes. (An example of a typical reason for being far outside the normal flight envelope would be a mid-air collision).

The so-called "abnormal attitude" law is:

Pitch alternate with load factor protection (without auto-trim)

Lateral direct law with yaw alternate.

These laws trigger, when extreme values are reached:

- *Pitch (50 < up, 30 < down)*
- *Bank (125 <),*
- *AOA (30 to 40 <, -10 <),*
- *Speed (440 kt, 60 to 90 kt),*
- *Mach (M 0.91).*

It is very unlikely that the aircraft will reach these attitudes, because fly-by-wire provides protection to ensure rapid reaction far in advance. This will minimize the effect and potential for such aerodynamic upsets.

The effectiveness of fly-by-wire architecture and the existence of control laws eliminate the need for upset recovery maneuvers to be trained on protected Airbus aircraft.

1.17.3.6 FCTM - Side-stick and takeover Priority Button

When the Pilot Flying (PF) makes an input on the sidestick, an order (an electrical signal) is sent to the fly-by-wire computer. If the Pilot Not Flying (PNF) also acts on the stick, then both signals/orders are added.

Therefore, as on any other aircraft type, PF and PNF must not act on their sidesticks at the same time. If the PNF (or Instructor) needs to take over, the PNF must press the sidestick takeover pushbutton, and announce: "I have control".

If a flight crewmember falls on a sidestick, or a mechanical failure leads to a jammed stick (there is no associated ECAM caution), the "failed" sidestick order is added to the "non-failed" sidestick order.

In this case, the other not affected flight crewmember must press the sidestick takeover pushbutton for at least 40 s, in order to deactivate the "failed" sidestick.

A pilot can at any time reactivate a deactivated stick by momentarily pressing the takeover pushbutton on either stick.

In case of a "SIDE STICK FAULT" ECAM warning, due to an electrical failure, the affected sidestick order (sent to the computer) is forced to zero. This automatically deactivates the affected sidestick. This explains why there is no procedure associated with this warning (Source: FCTM OP-020 Page 16/20).

1.17.3.7 OTM - Upset Training Syllabus

8.11.1 OBJECTIVE

Upon successful completion of training the trainee will be capable satisfactorily develop knowledge and ability for preventing and coping of aircraft upset.

8.11.2 APPLICABILITY

Upset Recovery Training is intended for Flight Crew.

8.11.3 MODULES

1. Ground Training

- A. Background.
- B. Definitions
- C. Causes of Aircraft Upset
- D. Aerodynamic & Aircraft Systems in relation with aircraft upset
- E. Recovery methods by considering various aircraft attitude and speed
- F. Post upset conditions

2. Simulator

- A. Flight Training (included malfunctions)
Practicing Nose High, Nose Low and High Bank Angle Recovery
- B. Debriefing
An adequate post-flight critique will be accomplished.

The aircraft operator advised the KNKT that the flight crew of PK-AXC had not received the upset recovery training on Airbus A320 training simulator.

1.17.3.8 Standard Operating Procedures

The following statements are significant quotations from the operator manual page PRO-NOR-SOP-22, page 6.

STANDARD CALLOUTS

To take control: The pilot calls out "I HAVE CONTROL". The other pilot accepts this transfer by calling out "YOU HAVE CONTROL", before assuming PNF duties.

To transfer communication, flight crewmembers must use the following callouts:

To handover communication: The pilot calls out "YOU HAVE RADIOS".

The other pilot accepts this transfer by calling out "I HAVE RADIOS".

To takeover communication: The pilot calls out "I HAVE RADIOS". The other pilot accepts this transfer by calling out "YOU HAVE RADIOS".

ABNORMAL AND EMERGENCY CALLOUTS

ECAM Procedures

- *"ECAM ACTION" is commanded by PF when required.*
- *"CLEAR (title of the system)?" is asked by the PNF for confirmation by the PF that all actions have been taken/reviewed on the present ECAM WARNING/CAUTION or SYSTEM PAGE. e.g.: CLEAR HYDRAULIC?*
- *"CLEAR (title of the system)" is the command by the PF that the action and review is confirmed. For status page; REMOVE STATUS will be used.*
- *"ECAM ACTIONS COMPLETE" is the announcement by the PNF that all APPLICABLE ACTIONS have been completed.*

- *Should the PF require an action from the PNF during ECAM procedures, the order "STOP ECAM" will be used.*
- *When ready to resume the ECAM the order "CONTINUE ECAM" will be used.*

STANDARD OPERATING PROCEDURES STANDARD CALLOUTS

The "SET" command means using an FCU knob to set a value, but not to change a mode.

SET is accomplished by only rotating the appropriate selection knob. Example:

- *"SET GO AROUND ALTITUDE"*
- *"SET QNH "*
- *"SET FL"*
- *"SET HDG"*

MANAGE/PULL

The "MANAGE" command means pushing an FCU knob to engage, or arm, a managed mode or target.

The "PULL" command means pulling an FCU knob to engage a selected mode or target. Example:

- *"PULL HDG 090"*
- *"MANAGE NAV"*
- *"FL 190 PULL"*
- *"FL 190 MANAGE"*
- *"PULL SPEED 250 KNOTS"*
- *"MANAGE SPEED"*

Note: If the value was previously set, there is no requirement to repeat the figure. Simply call e.g. PULL HDG: PULL SPEED: FL PULL

The VS/FPA selector knob has no managed function. The standard callouts for the use of this knob are as follows:

- *V/S Plus (or Minus) 700 PULL or*
- *FPA Minus 3° PULL (VIS (FPA) knob is turned and pulled)*
- *PUSH TO LEVEL OFF (VIS (FPA) knob is pushed)*

ARM

The "ARM" command means arming a system by pushing the specified FCU button. Example:

- *"ARM APPROACH"*
- *"ARM LOC."*

1.17.3.9 SOP-Standard Call Outs

Flight Parameters in Approach

Standard operating procedures chapter Standard Call outs page NOR-SOP-90 Page 5 describes standard call outs for approach and go around related to flight parameter such as:

- Final Approach
 - SPEED - if the speed decreases below the speed target - 5kts or increases above the speed target + 10kts
 - SINK RATE when V/S is greater than -1 000 ft/min.
 - BANK when bank angle becomes greater than 7°.
 - PITCH when pitch attitude becomes lower than -2.5° or higher than +10°.
- RNAV (RNP) Approach
 - "SINK RATE" when V/S is greater that -1 200 ft/min.
 - "BANK" when the bank angle goes above 30 °.
- During a go-around, the PM will make a callout for the following conditions:
 - "BANK": If the bank angle becomes greater than 7°,
 - "PITCH": If the pitch attitude becomes greater than 20° up or less than 10° up,
 - "SINK RATE": If there is no climb rate.

These standard call outs are only applicable for approach and go around phase.

1.17.3.10 QRH - General

GENERAL

SCOPE

The QRH contains some specific procedures which are not displayed on the ECAM. As a general rule, the procedures displayed on the ECAM are not provided in the QRH (refer to FCOM PRO/ABN).

TASKSHARING FOR ABN/EMER PROC

For all abnormal/emergency procedures, the task sharing is as follows:

- PF - Pilot flying - Responsible for the:

- *Thrust levers*
- *Flight path and airspeed control*
- *Aircraft configuration (request configuration change)*
- *Navigation*
- *Communications*

- PNF - Pilot non flying - Responsible for the:

- Monitoring and reading aloud the ECAM and checklists
- Performing required actions or actions requested by the PF, if applicable
- Using engine master switches, cockpit C/Bs, IR and guarded switches with PF's confirmation (except on ground).

ECAM CLEAR

DO NOT CLEAR ECAM WITHOUT CROSS-CONFIRMATION OF BOTH PILOTS.

ABN/EMER PROC INITIATION

Procedures are initiated on pilot flying command.

No action will be taken (apart from audio warning cancel through MASTER WARN light) until:

- *The appropriate flight path is established, and*
- *The aircraft is at least 400 ft above the runway, if a failure occurs during takeoff, approach, or go-around. (In some emergency cases, provided the appropriate flight path is established, the pilot flying may initiate actions before this height).*

COMPUTER RESET

When a digital computer behaves abnormally, as a result of an electrical transient, for example, the Operator can stop the abnormal behaviour by briefly interrupting the power supply to its processor.

The flight crew can reset most of the computers in this aircraft with a normal cockpit control (selector or pushbutton). However, for some systems, the only way to cut off electrical power is to pull the associated circuit breaker.

To perform a computer reset:

- *Select the related normal cockpit control OFF, or pull the corresponding circuit breaker.*
- *Wait 3s if a normal cockpit control is used, or 5s if a circuit breaker is used (unless a different time is indicated)*
- *Select the related normal cockpit control ON, or push the corresponding circuit breaker*
- *Wait 3s for the end of the reset.*

WARNING: *Do not reset more than one computer at the same time, unless instructed to do so.*

Note: *In flight, before taking any action on the cockpit C/Bs, both the PF and PNF must:*

- *Consider and fully understand the consequences of taking action*
- *Crosscheck and ensure that the C/B label corresponds to the affected system.*

The computers most prone to reset are listed in the table below, along with the associated reset procedure.

Specific reset procedures included in OEB or TDUs are not referenced in this table and, when issued, supersede this table.

- On ground, almost all computers can be reset and are not limited to the ones indicated in the table.

The following computers are not allowed to be reset in specific circumstances:

- ECU (Engine Control Unit on CFM engines), or EEC (Electronic Engine Control on IAE engines), and EIU (Engine Interface Unit) while the engine is running.
 - BSCU (Brake Steering Control Unit), if the aircraft is not stopped.
- In flight, as a general rule, the crew must restrict computer resets to those listed in the table, or to those in applicable TDUs or OEBs. Before taking any action on other computers, the flight crew must consider and fully understand the consequences.

CAUTION: Do not pull the following circuit breakers:

- SFCC (could lead to SLATS/FLAPS locked).
- ECU or EEC, EIU.

COMPUTER RESET TABLE

ATA	System malfunction or ECAM Warning/Caution	Affected System*	Reset
21	VENT AVNCS SYS FAULT	AEVC	On ground only: - Pull C/B Y 17 on 122VU - Wait 5 s before pushing the C/B.
	AIR PACK 1(2) REGUL FAULT	ACSC	On ground only: - Pull C/B W21 and W22 on 122VU - Pull C/B X21 and X22 on 122VU - Pull C/B Y18, Y20 and Y21 on 122VU - Pull C/B D8 on 49VU - Wait 5 s before pushing all the C/Bs.

 A318/A319/A320/A321 QUICK REFERENCE HANDBOOK	ABNORMAL AND EMERGENCY PROCEDURES	80.18C
		29 OCT 14

Continued from the previous page

ATA	System malfunction or ECAM Warning/Caution	Affected System`	Reset
	WINDSHEAR DET FAULT or AUTO FLT REAC W/S DET FAULT 	FAC 1+2	On ground only: The flight crew can cancel these alerts by resetting both FACs, one after the other - Pull the C/Bs B03 and B04 on 49VU and reset them after 5 s - Pull the C/Bs M18 and M19 on 121VU and reset them after 5 s

1.17.3.11 QRH - Stall Recovery

Stall Recovery was described in the Abnormal and Emergency procedure 80.08A. It indicated that as soon as any stall indication such as aural warning or buffet recognized, the pilot should push the side-stick forward to change the aircraft pitch down. This action could reduce the aircraft angle of attack.

The detail steps of the procedures shows as follow;

 A318/A319/A320/A321 QUICK REFERENCE HANDBOOK	ABNORMAL AND EMERGENCY PROCEDURES	80.08A
		29 OCT 14

STALL RECOVERY

As soon as any stall indication (could be aural warning, buffet...) is recognized, apply the immediate actions:

NOSE DOWN PITCH CONTROL..... APPLY
This will reduce angle of attack

Note: In case of lack of pitch down authority, reducing thrust may be necessary.

BANK..... WINGS LEVEL

● **When out of stall (no longer stall indications) :**

THRUST..... INCREASE SMOOTHLY AS NEEDED

Note: In case of one engine inoperative, progressively compensate the thrust asymmetry with rudder.

SPEEDBRAKES..... CHECK RETRACTED
FLIGHT PATH..... RECOVER SMOOTHLY

● **If in clean configuration and below 20 000 ft:**

FLAP 1..... SELECT

Note: If a risk of ground contact exists, once clearly out of stall (no longer stall indications), establish smoothly a positive climb gradient.

1.17.3.12 QRH - Tripped Circuit Breaker Re-Engagement

Tripped Circuit Breaker Re-Engagement was described in the Abnormal and Emergency procedure 80.16A, stated that: *“in flight not to reengage a circuit breaker that has tripped by itself, unless the Captain judges it necessary to do so for the safe continuing of the flight.”*

The detail of the procedures shows as follow;

 A318/A319/A320/A321 QUICK REFERENCE HANDBOOK	ABNORMAL AND EMERGENCY PROCEDURES	80.16A
		29 OCT 14
TRIPPED C/B RE-ENGAGEMENT		

In flight, do not reengage a circuit breaker (C/B) that has tripped by itself, unless the Captain judges it necessary to do so for the safe continuation of the flight. This procedure should be adopted only as a last resort, and only one reengagement should be attempted.
On ground, do not reengage the C/B of the fuel pump(s) of any tank. For all other C/Bs, if the flight crew coordinates the action with maintenance, the flight crew may reengage a tripped C/B, provided that the cause of the tripped C/B is identified.

1.17.3.13 Company Maintenance Manual (CMM)

3.5. Defect Report

PURPOSE

To ensure all defects reported are collated and significant technical problems investigated for the development of appropriate corrective action program.

Liaison with Regulatory Authorities / OEM on adverse defect findings.

Deferred defect policy.

Scope

Defect Reports for the purpose of this procedure shall cover the following:

All flight defects recorded by Flight Crew in the Technical Log and the rectification carried out.

Defects and rectifications recorded in the AMOS. (AMOS – Airlines Maintenance and Operational System).

3.6. Reliability Program

Purpose

To measure, monitor and control aircraft fleet performance and effectiveness of Indonesia Air Asia maintenance program, a system of continuous monitoring, alerting and problem analysis/ corrective action, provide monthly reliability report and conduct quarterly Maintenance Review Board Meeting.

Scope

This program shall apply in the operation of the Reliability Program in ensuring that all the maintenance processes are performed continuously and effectively to maintain aircraft in an airworthiness state.

Policy

- 3.6.1. *Detailed procedures outlining the statistical technique, policy guidelines on usage of statistical methods for verification of process capabilities in order to ensure continued airworthiness are reflected in Maintenance Reliability Program.*
- 3.6.2. *MRB of reliability will be chaired by Planning & Technical Services Manager which will be conducted quarterly.*
- 3.6.3. *Data collection and analysis is carried out by Air Asia Berhad Technical.*

Record Department by computerized system as per Maintenance Agreement between Indonesia Air Asia and Air Asia Berhad Malaysia and shall review and evaluate the following as required:

- *PIREPS*
 - *Technical logs*
 - *Maintenance Work sheet*
 - *Workshop report*
 - *Report on functional checks or special inspections*
 - *Store Issues /Report (e.g. Spare consumption)*
 - *Occurrence Report*
 - *Repetitive Defects*
 - *Other Source (e.g. ETOPS, RVSM, ILS CAT I/II)*
- 3.6.4. *As part of reliability program, Engine Condition Monitoring (ECM) policy ensures that engine deterioration at an early stage is detected to allow corrective action before safe operation is affected by ensuring that engine limit margins are maintained.*

ECM procedure calls for daily collection of the ECM data to monitor on-wing engine performance by the ground-based system. A report based on the daily data collection is generated daily.

3.7. MEL / DISPATCH DEVIATION MANDATORY GUIDE

Purpose

To establish a system of control and monitoring of MEL Maintenance Report 2 defects and its rectification to prevent exceeding MEL Repair Interval Limits.

POLICY/PROCEDURE

- 3.7.1. *The control and reporting of all MEL Maintenance Report 2 is the*

responsibility of the License Aircraft Maintenance Engineer / Authorized Holder.

3.7.2. No direct entries into the Maintenance Report 2 shall be permitted unless the deferred defect already been entry in MR1 as a reference.

3.7.3. For defects to be transferred to the Maintenance Report 2 (MR2), a cross-reference shall be made to the MEL when applicable.

5.1 Technical Log

Purpose

To ensure that technical log is correctly completed and appropriately take action by an authorized person.

Scope

All activities pertaining to the usage of the technical log in accordance with Technical Log Procedure and to ensure that technical log is correctly completed and appropriately auctioned by an authorized person.

Indonesia AirAsia aircraft Technical Log which consists of the following:

- 1. Maintenance Report 1 (MR1) - Technical Log Book*
- 2. Maintenance Report 2 (MR2) - Deferred Defect Log Book*
- 3. Transit Check and Fuel & Oil Log - Fuel & Oil records during transit activities*
- 4. Cabin Condition Log – Records Cabin Condition*
General of the instruction usage and filling guidance of the Technical Log are described in Quality Notice (QN-G-038) and also available on each of Log.

Policy

5.1.4. All maintenance work must be recorded and certified in the Technical Log.

5.3 Defect & Repetitive Defect

Defect

5.3.1 All defects found during Hangar Maintenance and routine check shall be recorded on the Inspection Cards (IC).

5.3.2 All defects still open in the Technical Log Book or Deferred Defects log book shall be transferred to the Inspection Cards (IC) for rectifications during the base maintenance input.

5.3.3 The Inspection Card (IC) is the Maintenance & Engineering Department document on which defects arising are recorded and rectified whilst an aircraft is undergoing Base Maintenance. It provides for nature of defect entry, action taken, by whom, parts replacement if any etc. and certification that such action has cleared the defect.

- 5.3.4 *The issue and return of Inspection Cards (IC) shall be controlled and monitored by Planning by tracking the sequential number allotted to each Inspection Card (IC) and each and every card issued against the maintenance input shall become part of the Maintenance Policy.*
- 5.3.5 *All defects must be rectified and certified by an appropriately Licensed Aircraft Engineer or a person holding an authorization issued by the Quality Assurance Manager for that particular function.*
- 5.3.6 *Defects found during Maintenance may be deferred under the following conditions:*
 - a) *The defect is deferrable in accordance to the Indonesia Air Asia Minimum Equipment List (MEL).*
 - b) *Non-availability of spares or insufficient downtime to rectify the defect without adversely affecting the operating schedule.*
- 5.3.7 *Items not listed in the Indonesia Air Asia MEL, which are not airworthiness or safety related such as aesthetics, cosmetics, passenger comfort or convenience related may be deferred due to non-availability of spares or downtime constraints.*
- 5.3.8 *All completed Inspection Cards (IC) shall become part of the Maintenance and shall be sent to Technical Records to enable update of records and safekeeping.*

Repetitive Defect

- 5.3.9 *All defects reported in the Technical Log must be rectified and certified by the authorized person. However permissible MEL or CDL items may be deferred subject non-availability of spares, manpower or insufficient ground time but in any event, such defects can only be deferred by an appropriately authorized person.*
- 5.3.10 *When deferring a defect or monitoring a repetitive defect, it must be necessary to keep flight crews or engineers at line stations informed of any non-standard configuration or limitations such as altitude, passenger load, fuel uplift etc. This being the case, entry into “notice to crew and engineers” in the Technical Log and inform Flight Operations.*
- 5.3.11 *A defect is deemed to be repetitive when it has been reported more than once in 7 flight sectors or 3 days where 3 rectification attempts have not positively cleared the defects. The Maintenance Manager will monitor and carry out follow up actions to ensure rectification of the repetitive object.*
- 5.3.12 *The cabin log shall not be used to enter any airworthiness defects. The Captain will sign the cabin log at the end of a flight. Any airworthiness defect found in the cabin log will be transferred to the technical log by the Captain/License /Approval Holders.*
- 5.3.13 *Monthly PIREPS statistics are reviewed by Maintenance Operation Manager to identify trends, repetitive component failure rate, high failure rate etc. to improve dispatch reliability and reduce cost.*

- 5.3.14 *Communicate all MEL items raised to main base by fax or e-mail.*
- 5.3.15 *Maintenance Control Procedures are contained in the EPM volume 2 explicitly provides for this.*
- 5.3.16 *The Maintenance Operation Manager is responsible to monitor all deferred defects and recurring defects. The priority for rectification shall be as follows:*
- a) *Time limited MEL.*
 - b) *Potential AOG e.g. single failure in a dual system etc.*
 - c) *Defects that imposes restrictions on aircraft e.g. altitude restriction etc.*
 - d) *Defects that affect passenger comfort and are not airworthiness related.*

Responsibilities

- a. *Rectification of Defects: Maintenance Operation Manager*
- b. *Issue and Control of Work Cards: Planning Officer.*

1.17.3.14 Engineering Procedure Manual

Chapter: 2. Line Maintenance Procedure

2.20 Repetitive Defects

2.20.1 Purpose

- *To identify line maintenance defects of repetitive nature.*
- *To provide a procedure for the effective control, monitoring and rectification of repetitive defects in the shortest and most economical manner without sacrificing reliability and airworthiness of the aircraft.*

2.20.2 Field of Application

The procedure applies to only repetitive defects that are deferrable and permissible in accordance to the Indonesia Air Asia Minimum Equipment List but closely monitored and plan for their rectification action. When monitoring of repetitive defects, flights crews and engineers at line stations need to be duly informed including the limitations associated with it such as altitude, runway requirement, fuel uplift and passenger load, flight profile, weather etc.

2.20.3 General

This procedure involves the following personnel:

- i. *Maintenance Operation Manager - MOM*
- ii. *Maintenance Operation Controller - MOC*
- ii. *Aircraft Maintenance Supervisor - AMS*
- iii. *Licensed Aircraft Engineer/Authorization Holder - LAE/AH*

2.20.4 Definition

A defect is categorized to be repetitive in nature under the following definitions:

- i. *Has been reported more than once in 7 flight sectors.*

- ii. *3 rectification attempts within a period of 3 days have not positively cleared the defect.*

2.20.5 Procedure

- a) *When reported defects falls into the repetitive category as defined above, MOC/AMS to extract AMOS-Work order Information system data to review the troubleshooting/rectification has been done.*
- b) *With comprehensive data from AMOS- Work order Information system, further rectification action can now be planned and formulated to clear the defect at all available opportunities.*
- c) *Each shift MOC / AMS shall appoint a LAE as the Engineer-in-charge of the defect from his shift to ensure continuity of the troubleshooting. The shift AMS together with his Engineer-in-charge, shall advise MOC and/or MOM on the progress.*
- d) *All rectification must be guided using the respective AMM / TSM troubleshooting guide for systematic remedial action.*
- e) *All work carried out must be entered in the Tech Log MRI for accountability.*
- f) *The MOC and/or MOM shall ensure that all the part/tooling/equipment required for continued troubleshooting are available and to expedite if they are not readily available by liaising with the Purchasing and Supplies department.*
- g) *The shift AMS of the night shift shall allocate the LAE's with the required number of men to continue rectification on the recurring defect.*
- h) *When an aircraft is scheduled for a minor or major maintenance check, rectify any recurring defect when longer ground time available.*
- i) *When a recurring defect is identified, the MOC and/or MOM must be duly informed by AMS. The MOC and/or MOM will monitor and ensure that rectification process is progressing systematically up to final rectification.*
- j) *The Recurring Defect will be considered closed after 7 days from the date of final rectification if nil re-occurrence is confirmed.*
- k) *MOC and/or MOM will work closely with Flight Operations by updating them on any flight profile limitations resulting from the recurring defect of the particular aircraft to ensure smooth operation.*
- l) *Upon rectification of the recurring defect, MOC and/or MOM shall advise Flight Operations to remove any restrictions or limitations imposed earlier as a result of this recurring defect.*
- m) *All parts and components replaced or normalized after each defect evaluation are to be appropriately tagged to affect the component status to facilitate follow-up action by Material Department.*
- n) *In the event that the defect still persists after all avenues of rectification have been pursued and exhausted, MOC and/or AMS shall promptly refer to Technical Services Department to seek further assistance from the respective*

manufacturer by providing the details of work scope carried out that was compiled during the course of troubleshooting for necessary reference.

2.34 LINE MAINTENANCE CHECKS

2.34.3 PROCEDURE

- f) *Defects may be deferred only under the following circumstances:*
- i. Deferrable defects as per MEL categories.*
 - ii. Non-availability of spares.*
 - iii. Item is not listed in MEL but non-airworthy in nature.*
 - iv. Eg. Passenger convenience.*
 - v. Discovery of defects during the check but with insufficient ground time to rectify may be deferred only if allowed by MEL, SRM or relevant manuals or documents.*

1.17.3.15 Reliability Manual

2.2. DATA SOURCES

During aircraft maintenance, data is gathered and this becomes the source of reference to evaluate and/or judge the reliability of the aircraft, its system, structures, components and power plants.

Information and data used in Reliability Program are collected from Indonesia AirAsia forms and reports.

A. Aircraft Flight and Maintenance Logs:

The Aircraft Flight and Maintenance Log is filled by

1. Flight Crew: On Flight Record, Engine Monitoring and Flight & Ground Finding section. Pilot is responsible for the report. Pilots should ensure that problem description/ flight remark information is adequate and factual.

2. Engineer: On Flight and Ground Finding, Maintenance Action, Component Replacement Record, Airframe hours, fuel, oil, hydraulic fluid, Pre-Flight/Transit/Daily check and Periodic Inspection section.

B. Cabin Crew Log:

This log is generated and completed by Cabin Crew.

C. Technical Delay Report:

This report is issued by Flight Operations Department and contains information concerning aircraft delays and cancellations, including reason of delay and its classifications.

The following table illustrates the types of data collected.

DATA SOURCE	DATA ELEMENTS / PROCESSES
MAINTENANCE LOG MR # 1 & MR # 2	<ul style="list-style-type: none"> ■ Aircraft hours & cycles ■ PIREPs ■ Component defects and change details ■ Aircraft defect and corrective action taken
HANGAR CHECK WORK PACKAGE	<ul style="list-style-type: none"> ■ Scheduled component removal ■ Unscheduled component defects tracking ■ Airplane defects and findings
SHOP REPORTS	<ul style="list-style-type: none"> ■ Component defect & shop findings ■ Component historical data
NON-ROUTINE DOCUMENTS	<ul style="list-style-type: none"> ■ System or component sampling ■ Investigation of significant findings

Chapter 3: Data analysis & corrective action

3.1. Reliability Parameters

Reliability Measures – Primary

The primary measure of aircraft reliability will be the Pilot Reports and Technical Delays, Cancellations and Incidents.

1. Pilot's Report.

The Program recognizes pilot reports which are related to the number of flight hours as a primary measure of systems/component reliability. Pilot Reports present the results of continuous operational monitoring and have proven to be a most logical and significant reliability measure.

2. Technical Delays and Cancellations,

Under the Reliability Program, maintenance delays and cancellations per 100 departures are also a primary measure of systems/component reliability. Technical delays and cancellations reflect problems that are affecting the day-by-day schedule reliability of the airline. The improvement to the program utilizing the result of the analysis of these problems will significantly increase the program ability to monitor aircraft systems/components and maintain a maximum state of fleet airworthiness.

3. Unscheduled engine and APU removals will also be the part of the primary reliability measures.

3.2. Data Analysis Methods and Applications

A. GENERAL

When a performance parameter arrives at the alert status, Technical Services issues an alert notice. Engineering will identify or determine appropriate corrective actions as well as preventive measures to avoid the occurrence of the same defect. When conditions warrant, any of records listed on paragraph 3.2.B will be utilized to help substantiate/justify:

1. *Aircraft Maintenance Reliability.*
2. *Improvement of:*
 - a. *Operation procedures,*
 - b. *Troubleshooting techniques,*
 - c. *Scope and frequency of maintenance processes (maintenance program),*
 - d. *Technical Publications,*
 - e. *Storage and Purchasing;*
3. *Evaluate :*
 - a. *Materials, fuels, and/or lubricants,*
 - b. *Existing repair organizations,*
 - c. *Existing of sources of spares;*
4. *The effectiveness of the modifications;*
5. *The evaluation and inventory of existing spares to support reliable operations.*

MSG2 and MSG3 analysis will also be used to determine the effectiveness of the correct maintenance interval and processes.

It will be the responsibility of the Engineering Support Department to determine the proper records and to establish substantiating method to be used in each case.

1.17.3.16 Troubleshooting Manual (TSM)

8. How to Use the CFDS

E. Maintenance functions

(1) First group: the PFR

Description of the PFR A maintenance report on the last flight is automatically printed after touchdown, 2 minutes and 30 seconds after the aircraft speed decreases below 80 kts.

This document is the Post Flight Report (PFR). The PFR is a result of the CFDS automatic operating mode.

This report is the main source of information used to initiate trouble shooting and to decide on the required maintenance actions.

1.17.4 Directorate General of Civil Aviation (DGCA)

The DGCA was responsible for regulatory oversight of the aircraft operator. This included the approval of the air operators certificate (AOC), approval of the operational and maintenance manuals and assessment of regulatory compliance.

1.18 Additional Information

1.18.1 Stall

Some important things to remember about the stall

- *For a given configuration and at a given Mach number, a wing stalls at a given Angle of Attack (AOA) called AOA STALL. When the Mach number increases, the value of the AOA STALL decreases.*
- *When approaching the AOA STALL, the wing generates a certain level of buffeting, which tends to increase in level at high Mach number.*
- *When the AOA increases and approaches the AOA STALL, in certain cases, a phenomenon of pitch up occurs as a result of a change in the distribution of the lift along the wingspan. The effect of the pitch up is a self-tendency of the aircraft to increase its Angle of Attack without further inputs on the elevators. Generally, for a given wing, this phenomenon occurs at a lower Angle of Attack and is more prominent when the Mach number is higher.*
- *The only means to counter the pitch up is to apply a nose down elevator input.*
- *When the aerodynamic flow on the wing is stalled, the only possible means to recover a normal flow regime is to decrease the AOA at a value lower than the AOA STALL.*
- *Stall is an AOA problem only. It is NOT directly a speed issue.*

Knowing those two last characteristics is absolutely paramount, as they dictate the only possible way to get out of a stall.

6. Protections against the stall in ALTERNATE and DIRECT LAW on

FBW (Fly by Wire) and conventional aircraft on FBW aircraft, following certain malfunctions, in particular in case of sensor or computer failure, the flight controls cannot ensure the protections against the stall.

Depending on the nature of the failure, they revert to ALTERNATE LAW or to DIRECT LAW. In both cases, the pilot has to ensure the protection against the stall, based upon the aural Stall Warning (SW), or a strong buffeting which, if encountered, is an indication of an incipient stall condition.

The conventional aircraft are permanently in DIRECT LAW, and regarding the stall protection, they are in the same situation as the FBW aircraft in DIRECT LAW.

In both ALTERNATE and DIRECT LAW, the aural SW is set at a value called AOA Stall Warning (AOA SW), which is lower than the AOA STALL.

The triggering of the Stall Warning just means that the AOA has reached the AOA SW, which is by definition lower than the AOA STALL, and that the AOA has to be reduced.

Knowing what the SW is, there is no reason to overreact to its triggering. It is absolutely essential for the pilots to know that the onset of the aural Stall Warning does not mean that the aircraft is stalling, that there is no reason to be scared, and that just a gentle and smooth reaction is needed.

The value of the AOA SW depends on the Mach number. At high Mach number, the AOA SW is set at a value such that the warning occurs just before encountering the pitch up effect and the buffeting.

If the anemometric information used to set the AOA SW is erroneous, the SW will not sound at the proper AOA. In that case, as mentioned above, the clue indicating the approach of the stall is the strong buffeting. In the remainder of this document, for this situation, “SW” must be read as “strong buffeting”.

9. How to react

What is paramount is to decrease the AOA. This is obtained directly by decreasing the pitch order. The pitch control is a direct AOA command (fig. 3).

The AOA decrease may be obtained indirectly by increasing the speed, but adding thrust in order to increase the speed leads to an initial adverse longitudinal effect, which trends to increase further the AOA (fig. 4).

It is important to know that if such a thrust increase was applied when the aircraft is already stalled, the longitudinal effect would bring the aircraft further into the stall, to a situation possibly unrecoverable. Conversely, the first effect of reducing the thrust is to reduce the AOA (fig. 5).

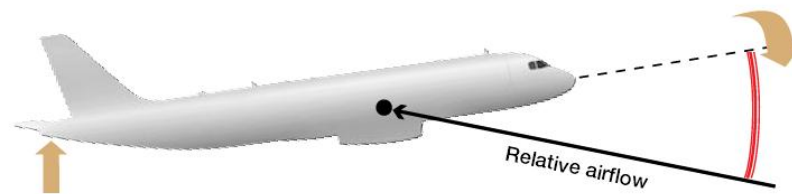

Figure 3 Pitch control is a direct AOA command

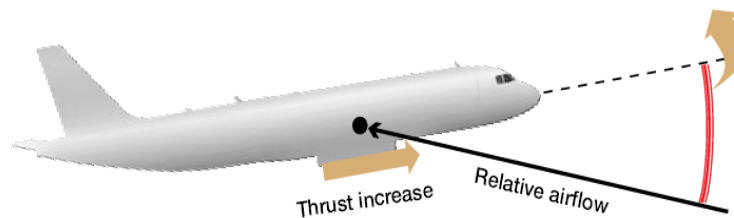

Figure 4 Adding thrust leads to an increase in AOA

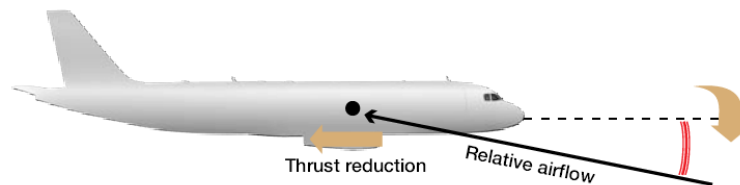

Figure 36: Reducing thrust leads to a decrease in AOA

In summary:

FIRST: The AOA MUST BE REDUCED. If anything, release the back pressure on stick or column and apply a nose down pitch input until out of stall (no longer have

stall indications). In certain cases, an action in the same direction on the longitudinal trim may be needed.

Don't forget that thrust has an adverse effect on AOA for aircraft with engines below the wings.

SECOND: When the stall clues have disappeared, increase the speed if needed. Progressively increase the thrust with care, due to the thrust pitch effect.

In practice, in straight flight without stick input, the first reaction when the SW is triggered should be to gently push on the stick so as to decrease the pitch attitude by about two or three degrees in order to decrease the AOA below the AOA SW.

During manoeuvres, the reduction of the AOA is generally obtained just by releasing the backpressure on the stick; applying a progressive forward stick inputs ensures a quicker reduction of the AOA.

If the SW situation occurs with high thrust, in addition to the stick reaction, reducing the thrust may be necessary.

10. Procedure

As an answer to the stall situation, a working group gathering the FAA and the main aircraft manufacturers, including Airbus, ATR, Boeing, Bombardier and Embraer, have established a new generic procedure titled "Stall Warning or Aerodynamic Stall Recovery Procedure" applicable to all aircraft types.

This generic procedure will be published as an annex to the FAA AC 120. This new procedure has been established in the following spirit:

- One single procedure to cover ALL stall conditions
- Get rid of TOGA as first action
- Focus on AOA reduction.

Generic Stall Warning or Aerodynamic Stall Recovery Procedure

Immediately do the following at the first indication of stall (buffet, stick shaker, stick pusher, or aural or visual indication) during any flight phases except at lift off.

1. Autopilot and auto-throttle Disconnect

Rationale: While maintaining the attitude of the aircraft, disconnect the autopilot and auto-throttle. Ensure the pitch attitude does not change adversely when disconnecting the autopilot. This may be very important in mis-trim situations. Manual control is essential to recovery in all situations. Leaving one or the other connected may result in in-advertent changes or adjustments that may not be easily recognized or appropriate, especially during high workload situations.

2. a) Nose down pitch control... Apply until out of stall (no longer have stall indications)

b) Nose down pitch trim As needed

Rationale: a) The priority is reducing the angle of attack. There have been

numerous situations where flight crews did not prioritize this and instead prioritized power and maintaining altitude. This will also address autopilot induced full back trim.

b) If the control column does not provide the needed response, stabilizer trim may be necessary. However, excessive use of trim can aggravate the condition, or may result in loss of control or in high structural loads.

3. BankWings Level

Rationale: This orientates the lift vector for recovery.

4. ThrustAs Needed

Rationale: During a stall recovery, many times maximum power is not needed. When stalling, the thrust can be at idle or at high thrust, typically at high altitude. Therefore, the thrust is to be adjusted accordingly during the recovery. For engines installed below the wing, applying maximum thrust can create a strong nose up pitching moment, if speed is low.

For aircraft with engines mounted above the wings, thrust application creates a helpful pitch down tendency. For propeller driven aircraft, thrust application energizes the air flow around the wing, assisting in stall recovery.

5. Speed BrakesRetract

Rationale: This will improve lift and stall margin.

6. BankWings Level

Rationale: Apply gentle action for recovery to avoid secondary stalls then return to desired flight path. (Airbus, 2011)

1.18.2 Stall

Fundamental to understanding angle of attack and stalls is the realization that an airplane wing can be stalled at any airspeed and any altitude. Moreover, attitude has no relationship to the aerodynamic stall. Even if the airplane is in descent with what appears like ample airspeed, the wing surface can be stalled. If the angle of attack is greater than the stall angle, the surface will stall.

Most pilots are experienced in simulator or even airplane exercises that involve approach to stall. This is a dramatically different condition than a recovery from an actual stall because the technique is not the same. The present approach to stall technique being taught for testing is focused on “powering” out of the near-stalled condition with emphasis on minimum loss of altitude. At high altitude this technique may be totally inadequate due to the lack of excess thrust. It is impossible to recover from a stalled condition without reducing the angle of attack and that will certainly result in a loss of altitude, regardless of how close the airplane is to the ground. Although the thrust vector may supplement the recovery it is not the primary control. At stall angles of attack, the drag is very high and thrust available may be marginal. Also, if the engine(s) are at idle, the acceleration could be very slow, thus extending the recovery. At high altitudes, where the available thrust is reduced, it is even less of a benefit to the pilot. The elevator is the primary control to recover from a stalled

condition, because, without reducing the angle of attack, the airplane will remain in a stalled condition until ground impact, regardless of the altitude at which it started.

Effective stall recovery requires a deliberate and smooth reduction in wing angle of attack. The elevator is the primary pitch control in all flight conditions, not thrust (FAA, 2008).

1.18.3 Rudder deflection

Refer to the technical systems discussion with the Airbus team on March 2015 the maximum speed of the Rudder Trim electrical motor is 5°/sec.

When the 26VAC CBs of both FAC were pulled, the loss of the 26VAC was detected by the FAC monitoring. However the FAC logic associated to the computation time and rudder movement inertia created a rudder movement of about 2°.

As both FAC were unavailable this rudder movement was not automatically compensated.

If the 28VDC C/B is pulled before the 26VAC C/B, the FAC is immediately powered off and no rudder movement can be ordered.

The rudder movement can only occur if the 26VAC C/B is pulled before the 28VDC C/B. The ECAM message “AUTO FLT FAC1+2 FAULT” is generated with the associated ECAM procedure asking to reset the FAC through the P/B on overhead panel.

After the FAC2 26VAC and 28VDC CBs have been pushed, there is no more rudder trim function available as no FAC was reset through the P/B on overhead panel. The message “AUTO FLT FAC1+2 FAULT” was still displayed.

1.18.4 Spatial disorientation and the Startle Reflex

Spatial disorientation (SD) (Ernsting, 2003) is a term used to describe a variety of incidents occurring in flight where the pilot fails to sense correctly the position, motion or attitude of his aircraft or of himself within the fixed coordinate system provided by the surface of the earth and the gravitational vertical. In addition, errors in perception by the pilot of his position, motion or attitude with respect to his aircraft, or of his own aircraft relative to other aircraft, may also be embraced within a broader definition of SD in flight.

If the disorientation phenomenon is not recognized immediately, it may lead to loss of control of the aircraft or controlled flight into terrain with disastrous consequences. Prevention of SD is thus an important step in enhancing flight safety.

If a pilot flying by reference to the aircraft's instruments is distracted from maintaining awareness of the aircraft's attitude, then gradual changes to the aircraft's orientation may go unnoticed. This is because changes at a rate below a certain threshold will not be perceived, possibly leading to spatial disorientation.

Mulder's Law (Dehart, 2002) describes a threshold (called Mulder's Constant) below which accelerations are not sensed by the human vestibular system. For an angular acceleration to be perceived, the product of the intensity or magnitude of acceleration (deg/s^2) and time (seconds) of application must reach a threshold value.

The best way to illustrate the meaning of Mulder's Law is with a few examples, where Mulder's Constant is assumed to be $2.5^\circ/\text{s}$:

1. If a person experiences an acceleration of $1^\circ/\text{s}^2$ for 1 second, he or she will probably not sense that acceleration because the product ($1^\circ/\text{s}$) does not exceed Mulder's Constant.
2. If the same acceleration occurs for 3 seconds, however, it will likely be detected (because the product, $3^\circ/\text{s}$, exceeds Mulder's Constant).
3. Even a large acceleration of $10^\circ/\text{s}^2$ will not be felt, if its duration is less than 0.2 seconds. The same acceleration will be felt, if its duration is 0.25 seconds or greater.

Startle Reflex

The human startle reflex was investigated by Landis and Hunt (1939) who filmed the reactions of people to an unexpected pistol shot occurring just behind them. There is a reflex-like event (startle reflex) that blinks the eyes and causes a whole body 'jerk' to occur (similar to that sometimes caused in sleep). This reflex has a relatively basic neural pathway from the sense organ. Many things can cause (or contribute to) a startle reflex, including sudden noises, unexpected tactile sensations, abrupt shocking perceptions, the sensation of falling or an abrupt visual stimulus.

There is little evidence that a startle reflex alone creates much of a sustained or lasting impact on cognitive functions (although there are some minor and short lived physiological changes such as raised heart rate). A skilled motor task will be momentarily disrupted by a startle reflex but return to normal within five to ten seconds (Thackray & Touchstone, 1970)

For pilots, the main effects of the startle reflex are the interruption of the on-going process and distraction of attention towards the stimulus. These happen almost immediately, and can be quickly dealt with if the cause is found to be non-threatening. However, the distraction can potentially reduce a pilot's concentration on flight critical tasks.

When we perceive a serious and imminent threat we react with an increased heart rate and breathing, secretion of adrenaline, and increased sweating, called the alarm reaction or 'fight or flight' response (stress). These changes immediately prepare the body for action to maximize the chances of survival in the anticipated imminent encounter. No startle is required to activate the fight or flight response, although a startling stimulus may be part of, or coincident with, the same threat

The details of related articles are attached in the appendix 6.8 of this report.

1.18.5 Airplane Upset

The Transportation Safety Board of Canada (TSB) report of the investigation of an inflight upset involving an Airbus A310 highlights the possibility of loss of control associated with unusual aircraft attitude¹⁴ (Transportation Safety Board of Canada, 2008).

Over the past few years, several accidents and incidents have occurred in which flight crew had to deal with an unusual aircraft attitude. Airline pilots seldom encounter very steep bank or pitch angles associated with this type of loss of control. There are many explanations for these losses of control, including factors related to the environment, the equipment and the crew, and a large portion of them can be attributed to environmental factors that cannot always be avoided or controlled.

Despite some variations depending on aircraft model, a loss of control occurs when one or more of the following situations arise:

- *Nose-up angle greater than 25°*
- *Nose-down angle greater than 10°*
- *Bank angle greater than 45°*
- *An angle within these parameters, but at an inappropriate speed for the flight conditions.*

1.18.6 Decision Making in a Dynamic Environment

The Transportation Safety Board of Canada report also discusses the crucial aspect of pilot decision making. (Transportation Safety Board of Canada, 2008)

Pilots make decisions in changing conditions where the information available reflects the dynamic environment in which the aircraft is operating. Studies have established that the decision-making process is a loop made up of three sequential steps: situational awareness, decision making and observation of the performance resulting from the decision. The crew must be aware of the actual situation to make an appropriate decision. In a cockpit, counterchecks and effective communication between flight crew members mitigate perception errors.

Situational awareness involves perceiving the elements of the actual situation, understanding the situation, and projecting the situation in time. Among other things, the training, knowledge, experience and preconceived notions of pilots are individual factors that influence their understanding of the situation.

Mental workload is an element that affects the decision-making process. It can be defined as the quantity of information to be analysed at a given time. Mental workload increases according to the quantity and complexity of the information received. In abnormal or urgent situations, pilots must analyse complex and

¹⁴ Transportation Safety Board of Canada Aviation Investigation Report A08Q0051, Out-of-Trim Nose Down Condition Leading to an Airplane Upset, Air Transat Airbus A310, Québec International Airport/Jean Lesage, Quebec, 5 March 2008. <http://www.tsb.gc.ca/eng/rappports-reports/aviation/2008/a08w0007/a08w0007.asp>

potentially conflicting information before arriving at an exact understanding of the situation, which is essential for implementing a suitable plan. An information overload can contribute to incorrect situational awareness.

When pilots experience information overload, they frequently concentrate on one part of the information to the detriment of the overall situation. Channelling information this way is beneficial only if the pilot has chosen the relevant information.

1.18.7 Civil Aviation Safety Regulation (CASR) part 121

121.406 Crew Resource Management Training

(a) No air carrier shall assign a person to act as a crewmember on any aircraft unless that person has received crew resource management training in accordance with the following:

(1) Initial training for all crewmembers shall cover the following subjects:

- (i) attitudes and behaviors,*
- (ii) communication skills,*
- (iii) problem solving,*
- (iv) human factors,*
- (v) conflict resolution,*
- (vi) decision making,*
- (vii) team building and maintenance, and*
- (viii) workload management.*

(2) Recurrent training as prescribed herein, shall be given every 12 months and cover safety and emergency procedures and where possible, include joint participation of pilots and flight attendants:

- (i) relationship of crew members,*
- (ii) review of incidents/accidents of air carriers,*
- (iii) presentation and discussion of selected coordinated emergency procedures, and*
- (iv) crewmember evacuation drills and debriefing.*

1.19 Useful or Effective Investigation Techniques

The investigation conducted in accordance with the KNKT approved policies and procedures, and in accordance with the standards and recommended practices of Annex 13 to the Chicago Convention.

2 ANALYSIS

The analysis will discuss the relevant events that led the aircraft while cruising at FL 320 encountered upset conditions.

The investigation found several maintenance records associated with the Rudder Traveller Limiter System in the last 12 months. Furthermore, the records also showed that the interval of the malfunctions became shorter in the last 3 months even though maintenance actions had been performed since the first malfunction was identified in January 2014.

The investigation also utilized information provided by Airbus and the aircraft operator including flight simulation on A320 level D training simulator to recreate the significant flight events recorded in the FDR.

The aircraft had deviated from the planned route to avoid weather and the recorders did not show any indication of the weather condition affecting the aircraft. The investigation considered that the weather conditions at the time did not contribute to the accident therefore weather issue will not be discussed in the analysis.

The display on the right PFD was not recorded in the FDR, therefore the analysis assumed that the right PFD display was similar with the left PFD, before the selection of CAPT 3.

The display of the left PFD was not available at some stages of the flight. For the analysis purposes, several parameters were taken from the Integrated Standby Instrument System (ISIS) and not the ADIRU1 which was the source of the Left PFD, as the data from this sources became unavailable from a certain time.

The analysis will therefore examine and discuss the events relating to the following issues:

- Un-commanded aircraft roll
- Electrical interruption
- RUD TRV LIM SYS message handling
- Side stick inputs
- Pilot recognition of stall
- Crew Resource Management
- Maintenance handling on aircraft system problem

2.1 Un-commanded aircraft roll

Between 2301 UTC to 2313 UTC the FDR and CVR recordings indicated three Rudder Travel Limiter Unit failures occurred and triggered the chime and master caution, followed by PIC actions to ECAM actions to reset FAC 1 and 2 push-buttons on the overhead panel to OFF then to ON. Thereafter both of Rudder Travel Limiter Units returned to function normally.

At 2315:36 UTC, the fourth failure on both Rudder Travel Limiter Units and triggered ECAM message “AUTO FLT RUD TRV LIM SYS” and triggered the chime and master caution light.

At 2316:29 UTC, the FDR recorded parameters which indicate that FAC 1 was de-energized leading to the ECAM FAC 1 FAULT message associated with the 5th master caution. 17 seconds later the FDR recorded parameters indicate that FAC 2 was also de-energized leading to the FAC 1+2 FAULT message associated with the 6th master caution. The FAC 1+2 FAULT was followed by rudder deflected 2° to the left, the aircraft flight control status reverted from Normal Law to Alternate Law and the Auto Pilot (A/P) and the Auto thrust (A/THR) disengaged. As consequence, the pilot should fly the aircraft manually.

The fault on FACs was associated with electrical interruption due to loss of 26VAC and 28VDC. Refer to the information provided by Airbus, when the loss of 26VAC was detected by the FAC, the FAC logic associated to the computation time and rudder movement inertia created a Rudder movement of about 2°. As both FAC were disengaged this rudder movement was not automatically compensated.

The FDR recorded that when FAC 1 was de-energized, the rudder deflected of about 0.6° at this time the FAC 2 took over the function of FAC 1 and the auto-pilot was still engaged. The FDR also showed the deflection of aileron to compensate the aerodynamic roll caused by rudder deflection hence the FDR did not record any heading change. The FDR did not record re-engagement of the FAC 1.

Seventeen seconds after the FAC 1 being de-energized, the FDR recorded that the FAC 2 was also de-energized leading to the FAC 1+2 FAULT message. As a consequence the A/P and A/THR disengaged, flight control law reverted from Normal Law to Alternate Law, and the rudder deflected 2° to the left causing the aircraft rolled to the left with rate of 6°/second.

After the auto pilot disengaged the pilot had to fly the aircraft manually. However when the aircraft rolled, neither pilots input the side stick to counter the aircraft roll until nine seconds later thereby the aircraft rolled left up to 54°.

The investigation concluded that the un-commanded roll was caused by the rudder deflection, the autopilot disengaged and no pilot input for nine seconds.

2.2 Electrical interruption

At 2316:29 UTC, the FDR recorded parameters indicating that FAC 1 was de-energized leading to the ECAM message FAC 1 FAULT, associated with the 5th master caution. At this time, the FDR also recorded rudder deflection of about 0.6°. FAC 1 de-energized situation lead to the unavailability of the following parameters indicated by parameter alternation between minimum and maximum parameter value: Rudder Travel Limited Unit (RTL) 1, Wind shear Detection 1 and Rudder Travel Limiter Actuator 1.

At 2316:39 UTC, the FDR recorded that the FAC 1 was re-energized indicated by stopping of parameter alternation. However because the FAC1 pushbutton on overhead panel was not reset by put to OFF then ON, the FAC1 functions remained unavailable and all equipment controlled by FAC 1 did not operating.

At 2316:46 UTC, the FDR parameters indicated that FAC 2 was also de-energized leading to the FAC 1+2 FAULT message associated with the 6th master caution and followed by:

1. Autopilot and Auto-thrust disengaged;
2. Rudder deflection 2° to the left;
3. FAC 2 de-energized situation lead to the unavailability of the following parameters indicated by parameter alternation between minimum and maximum value: Rudder Travel Limited Unit (RTL) 2, Rudder Travel Limiter Actuator 2, Wind shear Detection 2
4. Flight control law reverted from Normal Law to Alternate Law
5. Aircraft started to roll to the left.

At 2316:54 UTC the FAC 2 was re-energized indicated by stopping of parameter alternation.

The examination of the FDR parameters signature was similar to that of the flight on 25 December 2014, when the aircraft had RTL problem on the ground and the CBs were reset by pulling out and pushing back in.

The FDR recorded that the FACs were re-energized meaning that the FACs 1&2 28VDC CB were reengaged indicated by stopping of parameter alternation. However because the FACs 1&2 pushbuttons on overhead panel were not reset by put to OFF then ON, the FACs 1&2 functions remained unavailable. Re-energizing of the FAC 1&2 indicated that the CBs had been pushed back in. The FAC has two CBs which were 26 V AC and 28 V DC. A CB may pop out when electrical short circuit occurs, however to push it back in cannot be automatic, it requires external input.

Returning FAC CB back in during flight does not automatically make the FAC functions to be re-engaged and recover the function of the FAC, it requires resetting the FAC push button on the overhead panel as mentioned on ECAM Procedures. Without resetting the FAC pushbutton the FAC and all related systems remain not engaged even though the FDR shows some FAC FDR parameters are re-computed and recorded.

The FAC FAULT was due to electrical interruption which was likely due to the FAC CB being reset.

The activation of master caution was triggered by malfunction of RTL. Examination of the RTL concluded that the failure of the unit was caused by cracked soldering of the electronic module of both channel A and B as result of the thermal cycles associated to ON /OFF power and ground/flight conditions and generated a fatigue phenomenon of the soldering. The crack of soldering electronic module resulted to intermittent failure of the RTL.

The intermittent failure of RTL triggered the ECAM message AUTO FLT RUD TRV LIM SYS. The examination of the FAC 2 which was removed from the aircraft prior to the accident did not find any abnormality with the FAC.

2.3 RUD TRV LIM SYS Message Handling

The ECAM message of RUD TRV LIM SYS, the action was to push the FAC push button OFF then ON one by one. The action was intended to reset the FAC computers. The FDR recorded that following the activation of the master caution that was triggered by RUD TRV LIM SYS, the pilot performed actions as stated in the ECAM. After conducting the ECAM actions, the problem reappeared in shorter intervals. The pilot repeated the ECAM actions for three activations of the master caution. Unsuccessful result after taking the ECAM actions of RUD TRV LIM SYS may have led the crew to consider a different action.

On 25 December 2014, the PIC performed a flight from Surabaya to Kuala Lumpur with this aircraft. Prior to the flight a RTLU malfunction occurred on ground and the pilot witnessed resetting CB. The RTLU malfunction had not occurred until returning to Surabaya.

After completed this flight schedule and returned on 26 December 2014, the PIC's next flight assignment was on the 28 December 2014. The previous experience of seeing resetting the FAC CB may have triggered the PIC to perform a similar action in flight.

The Airbus A320 QRH chapter 'Computer Reset' stated that: *In flight, as a general rule, the crew must restrict computer resets to those listed in the table, or to those in applicable TDUs or OEBs. Before taking any action on other computers, the flight crew must consider and fully understand the consequences.*

The investigation considered the above statement can be interpreted that only the computer's CB listed in the TDU or OEBs were allowed to be reset in flight, however another statements allows to pull other computer CB as long as the pilot aware of the consequences.

The Airbus developed the statement to open the possibility for the operator in some circumstances allowed to reset another computer CB when "fully understand the consequences". One way of doing this is by consulting to Airbus.

The PIC had seen the engineer resetting the FAC CB on the ground. Having experience of witnessing and performing FAC CB reset, the PIC might consider that he "fully understand the consequences". Resetting the FAC CB on the ground and in flight has different consequences. The FAC CBs were not included in the list of the CB allowed in OEB and TDUs to be reset in flight. The consequences of resetting FAC CBs in flight are not described in Airbus documents. It requires good understanding of the aircraft system to be aware of the consequences.

Failure of both RTLUs will stop the rudder limiter at the last position, while the operation of the rudder will not be affected. The failure does not affect the continuity of the safe flight as the autopilot, auto-thrust and other systems controlled by the FAC are still available.

In the case of a failure occurs and the pilot willing to postpone solving the problem and decided to continue the flight except during take-off or go-around, several buttons on the ECAM panel may be used such as EMER CANC (emergency cancel) button and CLR (clear) button.

The EMER CANC button is to cancel (stop) an aural warning for as long as the failure condition continues and extinguish the master warning lights. Activation of this button will not affect the ECAM message display a malfunction other than the system that has been cancelled will be displayed on the ECAM.

The simulation showed that activation of Emergency Cancel button was effective to prevent pilot distraction by a repetitive malfunction of RTLU. The FCOM noted that this pushbutton should only be used to suppress spurious master cautions and the QRH mentions activation of EMER CANC button was only for landing gear not down warning.

The CLEAR button, activation of this button will clear the ECAM message without performing the ECAM action.

Review of the flight on 19 December 2014 showed two flights with 11 cautions and the second with 13 cautions with the pilot reset using the ECAM actions. If a pilot desired not to solve the problem by perform the ECAM action, one of these buttons may be operated. However, the FCOM stated that EMER CANC should only be used to suppress spurious master cautions. There are no other approved procedures for cancelling multiple, repetitive, cautions. Having unsuccessful result after taking the ECAM actions with the ambiguous statement in QRH and the experience of seeing the FAC CBs reset on ground might have made the pilot elected to reset the FAC CBs in flight.

2.4 Side stick inputs

After electrical interruption the autopilot disengaged and the ruder deflected at 2° then the aircraft rolled to the left without pilot input with a rate of 6° per second. This rate of roll was two times faster than normal roll rate operation. The SIC who acted as Pilot Flying responded 9 seconds after the autopilot off when the roll angle had reached 54°. Normally a pilot will respond immediately to level the wings when an aircraft is rolling without input by the pilot or normal system.

During the autopilot disengages and the ECAM message changed which triggered the master caution and chime this might attracted the crew attention. The delayed response of SIC as PF was likely due to his attention not being on the PFD, however the investigation could not determine to what the SIC's attention was directed at that time. The SIC possibly sensed the rolling movement of the aircraft due to the roll rate of 6° per second being greater than the vestibular sensitivity threshold of 2.5 ° per second according the Mulder's law.

At 23:16:53 UTC, the FDR recorded initial movement of the right side stick indicating that the SIC had become aware of the aircraft roll movement and had activated the side stick. The initial input of the right side stick as recorded on the FDR was backward movement up to 15° and then to the right up to maximum deflection.

The FCOM stated that the Flight Director the attitude bars (roll and pitch) will disappear from the PFD when the aircraft pitch attitude exceeds 25° up or 13° down. Therefore, at this state the pilots still have guidance from the Flight Director which could provide guidance to correct the situation by following the FD.

Observation on the FDR data during the straight and level flight with the A/P and A/THR engaged for existing aircraft weight and condition, the pitch attitude indicated almost steady at approximately 1.8° up. The initial SIC action on side stick input of up to 15.1° backward resulting in pitch attitude of 9° within 3 seconds (2316:55 UTC) was beyond the normal angle to regain the pre-set altitude 32,000 ft while the guidance from the Flight Director was still available.

The FDR recorded that the right side stick input was resulted to the aircraft roll to 9° to the left then to 53° to the left and the aircraft climbing. At this time, the FDR did not record any PIC side stick input in order to counter the situation.

The SIC might have been startled when he realized the unusual attitude of the aircraft, and this may have affected his reaction to the developing situation. At about the same time the CVR recorded the PIC said “oh my God”, expressing surprise. The startled reaction of the SIC may induce spontaneous or involuntary action and may degrade human performance¹⁷. The degraded human performance may impair the pilot’s situational awareness, decision making and problem solving, and also decrease critical skills in the handling of a complex emergency.

The initial SIC reaction was to pull the stick backward (pitch up command) then to the right up to maximum deflection. The result of this action was that the aircraft rapidly rolled to the right from 54° left to 9° left bank within 2 seconds. This rapid right rolling movement might have caused an excessive roll sensation to the right. Moreover the rudder deflection of 2° which was not recognized by the SIC, the deflection would tend the aircraft roll to the left might add more handling difficulty to level off the aircraft.

The SIC may have experienced spatial disorientation and over-corrected by shifting the side stick to the left which caused the aircraft to roll back to the left up to 53°. The SIC then shifted the stick to the right side with slower rate. This slower roll rate did not create an over-correction sensation. The aircraft then rolled to 2.5° to the left and pitch 5° up and the aircraft continued to climb.

2.4.1 First Aural Stall warning

Following the pitch up input on the right side stick, the aircraft continued climb then at 2316.56 the stall warning activated. The aural stall warning is designed to active when the aircraft reaches 8° AOA. This will provide sufficient margin to alert the flight crew in advance the actual of aerodynamic stall.

The operator manual (FCOM and QRH) stated that at this condition, the flight crew must apply the stall recovery procedure by lowering the nose to reduce AOA as soon as they recognized any stall indication either the stall warning or aircraft buffet. Stall recovery procedures have been trained for both pilots.

During the stall warning activated, the right side stick was at neutral then moved forward for two seconds. It caused the AOA decreased below 8°, and the aural stall warning stopped.

¹⁷ Human performance is the human capabilities both physical and psychological this include human information processing, situational awareness, stress, fatigue, etc.

The pitch up input of the right side stick has made the aircraft AOA increase and activated the stall warning which ceased after pitch down action was performed

2.4.2 Second Aural Stall Warning

One second after the first stall warning ceased, the right side stick command was at 12° backward causing the aircraft pitch up and climbing at a rate up to 11,000 feet/minute. The FDR did not record input of the PIC side stick.

The FDR recorded that after the first stall warning, the right side stick input was consistently back ward. This resulted in the aircraft continuously pitching up. The PIC commanded to the SIC “level...level”, which might refer to the previous condition of high roll angle. The stressful situation and instruction of the PIC likely made the SIC focus his attention to levelling the wings and less attention to the pitch input.

The first left side stick input was at 2317:03 UTC for 2 seconds, then 15 seconds later another input for 2 seconds, and at 2317:29 continued in dual input until the end of the recording.

The sidestick priority logic, when one pilot operates the sidestick, it will send the control signals to the computers. When both pilots move both sidesticks simultaneously in the same or opposite direction and neither takes priority, the system adds the signals algebraically. When this occurred, the two green Side Stick Priority lights are ON and followed by “DUAL INPUT” voice message activation. If this occurred, the PF or depending on the PIC instruction, should stop provides input on the sidestick or a pilot should stop the ‘dual input’ by pressing the priority pushbutton for 40 seconds or more to latch the priority condition. The FDR did not record neither pilots pressed such button for more than 40 seconds. The CVR did not record “DUAL INPUT” voice message as it was suppressed by “STALL” voice warning.

The FDR recorded at 2317:15 UTC the aircraft pitch reached 24° up. The PIC commanded ‘pull down...pull down’ and at 2317:17 UTC the FDR recorded second Stall Warning. Following the command ‘pull down...pull down’ the FDR recorded the SIC side stick backward input increased. The aircraft pitch and AOA were increasing.

The average of the side stick inputs recorded on the FDR since the A/P and A/THR disengaged until the aircraft encountered the second stall warning indicated that the SIC was pulling almost full back input while the PIC was slightly pushing nose-down. The sum of both side stick inputs commanded nose up pitch.

The pitch up input resulted in the AOA reaching a maximum of 48° which was beyond the flight director envelope and the flight director would have been disappeared from the PFD. The pilot would no longer have guidance from the flight director.

The pilot training for stall was intended to introduce the indications of approach to stall condition and recover it. While the aircraft system designed to prevent the stall by providing early warning. The pilot training and the aircraft system were intended to avoid stall.

The condition of AOA 40° as recorded on the FDR was beyond any airline pilot training competency as they never been trained or experienced.

The degraded SIC performance and ambiguous command of the PIC may have decreased the SIC's situational awareness. Consequently, the SIC did not react appropriately in this complex emergency situation. This resulted in an aircraft upset from which recovery was beyond the procedures and philosophy of training that was provided to flight crew and the increasing difficulty of aircraft handling as the result of the rudder deflection which provided roll tendency.

2.5 Pilot recognition of stall

Pilot training for stall in the flying school or during the training with the airlines normally is performed by conducting a level flight and then reduced the engine power, as the speed decreases the pilot increases the angle of attack in order to maintain the lift. When the aircraft reached the condition that may trigger the stall warning, the pilot then executes the recovery action. The aircraft may have not reached stall condition during the activation of the stall warning, which may give time to pilot to perform stall prevention action. This condition is known as approaching to stall. The purpose of this training is to introduce the symptom of initial stall condition and to avoid it by performing correct recovery action.

During the training, the pilot recognizes the stall or approaching stall condition occurs when the pitch (aircraft nose) is at up position.

Based on the aerodynamic principles stall occurs when the turbulence of the airflow above the wing occurs and the wing no longer produces adequate lift to counter aircraft weight. The main cause of stall is the angle of attack. The angle of attack is the angle between the airflow and the wing chord¹⁹. The action to recover from stall condition is by reducing the angle of attack which is normally performed by lowering the aircraft nose.

The FDR recorded:

- At 23:16:56, after the first STALL WARNING and buffet, the SIC applies nose down orders. The pitch stabilizes for 3 seconds.
- At 23:17:17, after the STALL WARNING, and buffet, the SIC releases back pressure or pitches down for 3 or 4 seconds.
- From 23:17:16, the “pull down” calls repeated many times and at short intervals followed by a majority of pitch up reactions of the PF (except at 23:17:17 after the second STALL WARNING).
- At 23:17:23 STALL WARNING and buffet become permanent. The SIC maintains a permanent pitch up order.

On this accident flight, the aircraft stall occurred when the aircraft climbed prior to reach the upset condition. While reaching the highest recorded altitude the aircraft was on upset condition with large bank angle, low speed and abnormal pitch attitude. The crew then focused on recovery of this condition.

¹⁹ Wing chord is the imaginary line between the leading edge and the trailing edge of the wing

The crew managed to recover the aircraft to level state (wing and pitch level), however the high AOA was still exist. The aircraft speed was below the aircraft stalling speed, engines were on cruise power, and the Vertical Speed Indicator (VSI) indicated the aircraft descent with the average rate of 12,000 feet per minute.

After this point, the FDR recorded that the aircraft pitch and roll were oscillating at relatively zero (level) position. The FDR did not record the signature of the pilot action to recover stall condition by lowering the nose (pitch down) as stated in the QRH Stall Recovery.

In normal condition, with the pitch and roll at close to 0° and both engines at cruise power will result in the aircraft at straight and level flight, not descending. Even if the aircraft is descending, at constant cruise power it will result in acceleration, enabling it to recover speed and lift. However, the indicated airspeed was constantly below the aircraft stall speed, the aircraft continued to lose altitude and the stall warning persisted to activate. This condition is obviously contradicting to what the pilot might have expected, which might have made the pilot failing to identify the stall condition as the pilot might have not had experience of stall at such aircraft attitude. The condition of stall at relatively zero pitch was not a standard on pilot training as the training for stall is performed on high pitch attitude. The Angle of Attack (AOA) which at a later stage was reaching 40° up was not indicated in the cockpit. The pilot might have not recognized the high AOA despite the stall warning and the buffet.

The pilot training was exercise to approach to stall which means that the aircraft has not entered stall condition. The condition of stall on this accident flight might have not been recognized by the pilot.

The CVR recorded that the Captain commanded to select air data to 'CAPT3'. This action would result in the transfer of the air data source from ADIRU1 to ADIRU3. The captain might have assumed that air data error had triggered the rapidly fluctuating airspeed indication of the PFD as recorded in the FDR.

The aircraft flight condition that is contrary to the normally expected condition and the pilots having not been introduce to stall condition might have made the pilot failing to identify the stall and did not initiate recovery action.

Some articles related to stall describes that aircraft attitude has no relation to the aerodynamic stall. Even if the airplane is in descent with what appears like ample airspeed, the wing surface can be stalled. If the angle of attack is greater than the stall angle, the surface will stall. Stall is an AOA problem only. It is NOT directly a speed issue. The first respond to stall prevention and recovery is to reduce AOA by performing a nose down pitch.

The AOA decrease may be obtained indirectly by increasing the speed, but adding thrust in order to increase the speed leads to an initial adverse longitudinal effect, which trends to increase further the AOA.

It is important to know that if such a thrust increase was applied when the aircraft is already stalled, the longitudinal effect would bring the aircraft further into the stall, to a situation possibly unrecoverable. Conversely, the first effect of reducing the thrust is to reduce the AOA (Airbus, 2011)

The Upset Recovery training was included in the aircraft operators training manual. The aircraft operator advised the KNKT that the flight crew had not *been trained for* the upset recovery training on Airbus A320, and this referred to *FCTM Operational Philosophy: “The effectiveness of fly-by-wire architecture, and the existence of control laws, eliminates the need for upset recovery maneuvers to be trained on protected Airbus”*. There was no evidence of DGCA findings for this incompliance of training.

2.6 Crew Resource Management

The CASR part 121.406 stated the requirement subjects for the Initial and Recurrent training. The flight crew records showed that both pilots had performed the initial and recurrent CRM training. The simulator recurrent and proficiency check also assess the CRM.

The flight crew CRM assessment records during Proficiency checks showed that the PIC was graded standard. The SIC had remarks in situational awareness, workload management and communication which were later corrected and graded as Satisfactory with Briefing.

This chapter of this analysis will discuss on the coordination between the pilots which refer to the Crew Resources Management (CRM). The analysis will focus on communication, coordination and leadership.

Communication and coordination

Resetting the FAC CB caused the autopilot and auto-thrust to disengage and flight control to revert to Alternate Law. The 6th master caution illuminated followed by the AUTO FLT FAC 1+2 FAULT ECAM message.

The FAC CB was not in the list of CB that were approved to be reset in flight and required for the pilot to understand the consequences. Following the CB reset, the ECAM displayed several messages that required pilot action. The consequences of resetting the FAC CB such as disengagement of the autopilot or flight control law reverted to Alternate Law might have not been anticipated by the pilots.

The consequences of resetting the CB should have been discussed by the crew to consider the risks and action plan by referring to Crew Coordination during Emergencies or Abnormalities (COM Chapter 4.10.1.7). The crew coordination includes the PF responsibility for handling the flight and PM for checklist reading and execution of required actions on PF request.

The recorder showed that the FAC 1 CB was reset 54 seconds after the activation of the 4th master caution. During this period communication between the SIC and PIC recorded on the CVR was unintelligible. Assuming that during these 54 seconds both pilots discussed the plan and consequences of resetting the FAC CB, the time available would not have been sufficient. The discussion should have included a review of the CB's allowed to be reset in flight in the TDU and OEB table. The evidence of the SIC delayed action when the autopilot disengaged indicated that the SIC did not anticipate the autopilot disengagement.

The unanticipated condition might have made both pilots focus on correcting the

condition indicated by dual input and no pilot performed the ECAM action.

After the autopilot disengaged, the PIC commands were ambiguous such as;

- “level...level”, which can be interpreted as “wings level” or “pitch level”. The SIC performed roll correction then the aircraft roll was controlled.
- “Pull down” bears an internal contradiction as “pull” suggests up, while “down” means down. Both cannot be done at the same time. The aircraft pitch increased and whenever the PIC repeated the command ‘pull down’ the backward input on the right side stick increased. The aircraft pitching up until the angle of attack reached a maximum of 48°.

Examination on the standard operating procedures chapter Standard Call outs NOR-SOP-90 Page 5 describes that the standard call outs for approach and go around related to flight parameter such as for SPEED, SINK RATE and BANK. These standard call outs will be announced by the PM when the aircraft is out of the limits specified and only valid for final approach and go around.

The non-standard call out might contribute to inappropriate action of the SIC, since the PIC commands did not clearly specify the targets (roll, pitch) or the action to achieve them.

The ineffective crew communication prior to the decision to reset the CB and the subsequent ambiguous commands might have caused the deviation from the goal of solving the aircraft system malfunction and correcting the aircraft condition.

Crew coordination

The FDR recorded that the PIC side stick priority button was pushed twice with the period of two and five seconds. This condition occurred during the dual input while the aircraft was in aerodynamic stall. The stall and the dual input were continuing until end of the recording. The stall condition is classified as an emergency which the operator’s FCTM states that the PIC may take over aircraft control.

As of the aircraft system, the flight crewmember who intend to take over must press the side-stick takeover pushbutton for at least 40 s, in order to deactivate the other side-stick. The activation of priority button for two and five seconds did not indicate that the crew intended to take over the control.

The standard call out to take over control, as described in the operator SOP, is “I HAVE CONTROL” and responded by the other pilot transferring the control by call out “YOU HAVE CONTROL”. The CVR did not record any command to take over the control.

Cockpit selections are normally the task of the PM. However, the PIC commanded the SIC to select ‘CAPT 3’ air data source. This command indicates that the PIC may have assumed the role of PF, without the appropriate announcements.

Without clear coordination on the role of PM and PF, this resulted in both crewmembers providing separate inputs to the flight control system. With the SIC pulling back on the side stick for most of this segment, the nose down (forward) pitching commands of the PIC were ineffective because of the summing function of the system, resulting in no effective or sustained nose down commands to the flight controls.

As of CRM perspective, the investigation concludes that there was ineffective communications and absence of coordination both prior to and during the flight encountering the upset. Such particular conditions contributed to the missing of tasks priority to achieve when in the critical and limited time. The condition continued and created more pilot workload.

2.7 Maintenance handling on aircraft system problem

The factual information revealed that during the flight, four times activation of master caution initiated from the unresolved RTLU problem. Therefore the investigation divided the analysis in two areas which focus on Line Maintenance and Maintenance Organization.

2.7.1 The Line Maintenance

The aircraft daily maintenance activity is performed by line maintenance personnel who are responsible to maintain the aircraft serviceability. When aircraft problem cannot be resolved by line maintenance personnel, the rectification will handle with special method by another department.

The aircraft maintenance handling rely on the manufacture manual including in the execution of the rectification action to any defect either reported by the flight crew or maintenance personnel.

The Airbus A320 equipped with the Centralized Fault Display System (CFDS) that provide information of current or historical problem arises during the operational of the aircraft. The maintenance personnel can access the data through the display system or printed Post Flight Report (PFR).

Airbus also provides the maintenance personnel with the Trouble Shooting Manual (TSM) which contain information to troubleshoot the effected system stated in the PFR and identified the suspected defective part.

The Airbus TSM stated that PFR is the main source of information use to initiate trouble-shooting and to decide on the required maintenance action.

The PFR Failure Messages between 27 November until 27 December 2014 were dominated by the Failure Messages of “AFS: FAC1/RTL ACTR 4CC” or “FAC2/RTL ACTR 4CC”. For these PFR Failure Messages, the TSM stated that two tasks are applicable:

- Task 22-61-00-810-803-A Loss of the Rudder Limiting Function on the FAC1.
- Task 22-61-00-810-804-A Loss of the Rudder Limiting Function on the FAC2.

These two tasks require replacement of the electronic module of the RTLU if problem persists. Apparently the replacement was never considered because at every occurrence the maintenance action taken by performing the BITE test was passed with satisfactory result. The BITE test was according to the TSM 22-61-00-810-803-A point 1, therefore, further step of the TSM was considered not necessary. The maintenance actions related to the PFR were not inserted to MR1, therefore any recurring problem was not considered as repetitive problem.

During the interview, the management IAA stated that the company policy is referring to the pilot report or Maintenance Report 1 (MR1) as the main source of the defect handling and the maintenance action performed must be recorded in the Technical Log.

The ICAO Annex 6 stated that one of the duties of pilot in command is to report all known or suspected defects in the aircraft after completion of the flight. This requirement had not been implemented in the Indonesian CASRs. In fact, not all pilot reported the defect occurs during flight.

If a defect is reported by the flight crew via an MR1 entry in the technical log book, the line maintenance personnel will check and verify the PFR in order to confirm the defect. From the PFR the relevant chapter on the TSM can be identified and relevant maintenance action taken to rectify the defect. If the PFR is not available due to a CFDS or PFR printer failure, then the relevant troubleshooting procedures can also be found in the TSM. There was no requirement for the Line Maintenance Personnel to record on the technical log for rectification based on PFR.

The technical log contains maintenance action based on MR1. Maintenance action without MR1 reference was not recorded on the technical log. This condition might result in line maintenance personnel not aware that the problem has been arose several time and the maintenance action taken by previous line maintenance personnel. This condition might also result in unrecorded several problems as repetitive defects that was reported on the PFR but not reported on MR1.

MR1 record on 21 December to 27 December 2014 found 2 pilot reports related to RTLU while the FDR recorded at least 9 problems appeared on the PFR.

Based on PK-AXC 1 Year report, 23 occurrences related with the RTLU problem were recorded since January 2014. The line maintenance personnel performed similar action by resetting the FAC and doing the AFS Operational test which resulted satisfactory and the problem was considered close. Any repeating defect was treated as a new defect.

Refer to the CMM chapter 5.3 Defect & Repetitive Defect stated : *A defect is deemed to be repetitive when it has been reported more than once in 7 flight sectors or 3 days where 3 rectification attempts have not positively cleared the defects.*

Evaluation of MR1 data December 2014 found 10 pilot reports related to RTLU occurred on 1, 12, 14, 19, 21, 24, 25 (two cases), 26 and 27 December 2014. On 19 December 2014, the repetitive RTLU problem was inserted to MR2.

Repetitions of the problem were not classified as repetitive problem as the rectification by AFS test were resulted satisfactory and the problems were considered solved. Actually the rectification by AFS test did not completely solve the problem.

The RTL trouble was inserted to the MR2 on 19 December 2014 and was closed at the same day after completion of the flight. The rectification was performed by resetting the FAC and doing the AFS Operational test. The result of the AFS test was satisfactory and the MR2 was closed.

The MR1 showed that on 23 December 2014, there was an entry report to update the aircraft document while the PFR data recorded 4 RTLU problems, which was not reported in the MR1. Since there was no requirement for the Line Maintenance Personnel to record on the technical log for rectification based on PFR therefore, the RTLU problems were not recorded on the technical log.

The company did not clearly state the policy of recording defect handling captured by the CFDS system or printed PFR and mainly based on MR1. It resulted in the line maintenance personnel did not aware of similar problem and repeat similar maintenance action, and also the problem was not recorded as a repetitive problem. None of the issues reported was identified as meeting the repetitive defect definition which would have triggered maintenance actions under the CMM requirements.

2.7.2 The Maintenance Organization

The IAA maintenance organization utilizes an integrated system Aircraft Maintenance and Operation System (AMOS) for the maintenance management including defect management and repetitive problem. The AMOS collects the information from MR1, Cabin Maintenance and Scheduled Inspection. The line maintenance personnel are responsible to enter the defect report recorded in the MR1 into the AMOS including the rectification action taken. The licensed aircraft maintenance engineer is responsible to enter the problem to MR2 when it meets the criteria.

The Line Maintenance is managed by Maintenance Operation Manager (MOM). MOM responsibility includes to monitor the rectification of the problem and the preparation of the spare part if required, utilizing the AMOS data.

The analysis of the defect for the purpose of Reliability Monitoring is controlled by Planning & Technical Service Manager (PTM) using data from AMOS. The summary and analysis of the problem or repetitive problem recorded in the MR1 will be reported in the monthly Reliability Report.

The Reliability Report of November 2014 for PK-AXC contained information of the RTL 1 problem that was occurred 4 times and were considered closed and noted “No further action required”. Meanwhile the ‘PK-AXC 1 Year Report’ recorded 3 problems of RTL 1, 1 problem of RTL 2 and 1 problem of RTL SYS in the same period.

The AMOS does not utilize PFR data. The unclear policy of inserting maintenance action into the MR1 for the rectification following PFR message resulted in not all PFR data are recorded. The analysis of the Reliability Report without optimizing PFR data resulted in un-comprehensive conclusion and led to the unresolved of repetitive occurrences.

The Airbus Troubleshooting Manual (TSM) stated that the PFR is the main source of information used to initiate trouble shooting and to decide on the required maintenance actions.

The operator maintenance system only recorded partial report of PFR data including the associated maintenance action, resulted in inadequate data to identify and analyse the defects. Thereafter it resulted in a missed opportunity to identify and rectify a series of recurring RTLU faults.

3 CONCLUSION

3.1 Findings

These findings should not be read as apportioning blame or liability to any organization or individual. The KNKT determines that the findings of this investigation are listed as follows:

Operation

1. The aircraft was airworthy prior to the occurrence and was operated within the weight and balance envelope.
2. The crew held valid licenses and medical certificates. The PIC last proficiency check was on 18 November 2014 and the SIC was on 19 November 2014, both were assessed as satisfactory.
3. In this flight, the Second in Command acted as Pilot Flying (PF) and the Pilot in Command (PIC) acted as Pilot Monitoring (PM).
4. The aircraft took off from Surabaya at 2235 UTC and cruised at flight level 320 with intended destination of Singapore via airways M635.
5. The weather on route of M635 partially covered by the Cumulonimbus clouds formation between 12,000 feet up 44,000 feet. The FDR data indicated that the flight was not affected by the weather condition and investigation concludes that the weather was not factor to the accident.
6. When the aircraft was cruising, there were three master caution activations associated with Rudder Travel Limiter Units (RTLUs) and the amber ECAM messages "AUTO FLT RUD TRV LIM SYS" between 2301 and 2313:41 and the pilots performed the ECAM actions and the system returned to function normally.
7. At 2315:36 UTC, the fourth master caution and triggered ECAM message "AUTO FLT RUD TRV LIM SYS", the recorder did not record any ECAM actions.
8. At 2316 UTC, the Jakarta Radar controller issued a clearance to the pilot to climb to FL 340 but was not replied to by the pilot.
9. At 2316:27 UTC, the fifth Master Caution illuminated which was triggered by FAC 1 FAULT followed by FDR signature of alteration of parameters of components controlled by FAC 1 such as RTLUs, Windshear Detection 1 and Rudder Travel Limiter Actuator 1. Twelve seconds later, the FAC 1 parameter back to ON and all fluctuating parameters stopped.
10. At 2316:44 UTC, the sixth Master Caution triggered by AUTO FLT FAC 1 + 2 FAULT and followed by FDR signature of alteration of parameters of components controlled by FAC 2. The Auto Pilot (A/P) and the Auto-thrust (A/THR) disengaged, and the Flight control law reverted from Normal Law to Alternate Law. The rudder deflected 2° to the left.

11. The fault on FACs was associated with an interruption of electrical power which was likely due to the FAC CB being reset.
12. At 2316:54 UTC the FAC 2 parameter was back to ON and all fluctuating parameters stopped. The autopilot and auto thrust remained disengaged. Flight control law remained in Alternate Law.
13. The FAC pushbutton on overhead panel was not reset to OFF then ON, as a result the FAC functions remained unavailable and all equipment controlled by FAC did not operating.
14. The rudder deflected 2° resulting in a roll rate of 6 degrees/second to the left, and without pilot input for 9 seconds, resulting the aircraft rolling to the left un-commanded up to 54°.
15. The delayed response of the SIC was likely due to his attention not being directed to the PFD as many events occurred at this time. However, the investigation could not determine where the SIC's attention was directed at that time.
16. The SIC might have been startled when he realized the unusual attitude of the aircraft, as indicated by the CVR record of self-expression.
17. After the right side-stick activated, the aircraft roll angle reduced to 9° left. This rapid right rolling movement might cause an excessive roll sensation to the right. The SIC may have experienced spatial disorientation and over-corrected by shifting the side stick to the left which caused the aircraft rolled back to the left up to 50°
18. The initial SIC action on side stick input of up to 15.1° backward resulting in pitch attitude of 9° within 3 seconds (2316:55 UTC) and was beyond the normal angle to regain the pre-set altitude of 32,000 ft while the guidance from the Flight Director was still available.
19. The FDR recorded at 2317:15 UTC the aircraft pitch reached 24° up. The PIC commanded 'pull down...pull down' however the FDR recorded the right side stick backward input increased resulting in the AOA increased up to a maximum of 48° up. The Standard Call Out applicable during final approach and go-around mentioned in SOP should be "PITCH, PITCH" if the pitch angle reaches 10°. There were no standard call outs for flight phases outside the final approach and go-around.
20. The degraded performance and ambiguous commands might have decreased the SIC's situational awareness and he did not react appropriately in this complex emergency resulting in the aircraft becoming upset.
21. At 2317:17 UTC, the stall warning activated and at 2317:22 UTC stopped for 1 second then continued until the end of recording.
22. From 2317:29 UTC the PIC side stick input started to become active with nose down pitch commands and then mostly at neutral while the SIC side stick input was mostly at maximum pitch up until the end of the recording.
23. At 2317:41 UTC the aircraft reached the highest altitude of 38,500 feet and

largest roll angle of 104° to the left. The aircraft then lost altitude with a rate of up to 20,000 feet per minute.

24. At 2318 UTC, the aircraft disappeared from the Jakarta Radar controller screen at the coordinates of 3°36'48.36"S - 109°41'50.47"E.
25. The last data recorded by the FDR were at 2320:35 UTC with the airspeed of 83 kts, pitch 20° up, AOA 50°, roll 8° to left, with the rate of descend of 8,400 ft/minute at a radio altitude of 187 feet.
26. After the A/P disengaged, there was no communication between pilot and ATC until the end of recording.
27. The recorded FDR parameter fluctuations were similar to those recorded on 25 December 2014 when the aircraft had a RTL problem on the ground and the CBs were reset.
28. The experience of the PIC witnessing problem solving by resetting the FAC CBs on 25 December 2014 might have influenced the PIC to adopt the same procedure when confronted with the same problem.
29. The FAC1 CBs were located on the overhead panel, while the FAC2 CBs were behind the right pilot seat. To be able to pull or push the FAC2 CBs, a pilot has to leave the control seat.
30. Observation on the Airbus A320 QRH, in the chapter 'Computer Reset' it is stated that: *In flight, as a general rule, the crew must restrict computer resets to those listed in the table. Before taking any action on other computers, the flight crew must consider and fully understand the consequences.* This statement was potentially ambiguous to the readers and might be open for multiple interpretations.
31. Prior to the decision to reset FAC CBs the CVR recorded unintelligible discussion.
32. The flight crew had not received the operator upset recovery training on Airbus A320 as it was not required according to the Airbus FCTM.
33. The stall warning is designed to activate at 8° AOA and known as approaching to stall and this will provide sufficient margin to alert the flight crew and take the correct action prior to the actual aerodynamic stall which will occurs well beyond the AOA of stall warning. The aircraft system and the pilot training were intended to avoid stall.
34. The pilots were trained and had experience of recover from the approaching stall. The condition of stall at zero pitch had never been trained as the training for stall was always with a high pitch attitude.
35. The stall condition is classified as an emergency which required the PIC to take over control. The CVR did not record any command by the PIC that they were taking over control of the aircraft using the standard call out. The standard call out to take over control described in the operator SOP, is "I HAVE CONTROL" and responded by the other pilot transferring the control by call out "YOU HAVE CONTROL" or by activating the priority button for 40 seconds.

36. The approved Operation Training Manual for flight crew, Chapter 8: described the Special Training, sub-chapter 8.11 the upset recovery. The upset training has not been implemented on Airbus A320 as described in this manual.
37. The FCTM stated that the effectiveness of fly-by-wire architecture and the existence of control laws eliminate the need for upset recovery manoeuvres to be trained on protected Airbus.
38. Since 2317:29 UTC, both left and right side stick input were continuously active until the end of the recording. The input were different where the right sidestick was pulled for most of this segment, the nose down (forward) pitching commands of the left sidestick became ineffective because of the summing function of the system, resulting in ineffective control the aircraft
39. There was no approved means for flight crews to handle multiple or repeated Master Caution alarms in order to reduce distraction.
40. ICAO Annex 6 stated that one of the duties of pilot in command is to report all known or suspected defects in the aircraft after completion of the flight. This requirement has not been included on the current Indonesia Civil Aviation Safety Regulation (CASR).

Maintenance

41. The maintenance records showed that there were 23 Rudder Travel Limiter problems starting from January 2014 to 27 December 2014.
42. The Reliability Report November 2014 recorded 4 pilot reports regarding the RTLU problem.
43. On 19 December 2014, the repetitive RTLU problem was inserted to MR2. After completing the scheduled flight, the maintenance personnel performed Auto Flight System (AFS) and the MR2 was considered closed.
44. On 21 December to 27 December 2014, the MR1 recorded 2 pilot reports on 25 December 2014 and on 27 December 2014 related to RTLU while the FDR recorded at least 9 problems.
45. The operator maintenance management utilized AMOS to manage maintenance activities. The data was uploaded by the maintenance personnel in all line maintenance stations. The information is collected from MR1, Cabin Maintenance and Scheduled Inspection.
46. Maintenance data analysis related to RTLU problem was inadequate because it was only based on the MR1 which are available in the AMOS, while other information such as from the PFR was not utilized.
47. The existing maintenance data analysis led to unresolved repetitive faults occurring with shorter intervals.
48. Evaluation of the maintenance data showed that the maintenance action following the RTLU problems were mostly by resetting computer by either resetting the FAC push button and followed by AFS test or resetting the associated CBs.

49. The examination of the RTLU found electronic module shown the evidence of cracking of solder on both channel A and channel B. The crack could generate loss of electrical continuity and led to RTLU failure.
50. The company policy stated that maintenance personnel shall enter to the MR1 after the performance of rectification based on pilot report while for the rectification initiated by the PFR was not clearly stated. While the Airbus Trouble Shooting Manual stated that PFR is the main source of information used to initiate trouble shooting and to decide on the required maintenance actions.
51. The CMM chapter 5.3 Defect & Repetitive Defect stated: *A defect is deemed to be repetitive when it has been reported more than once in 7 flight sectors or 3 days where 3 rectification attempts have not positively cleared the defects.*
52. The company policy did not clearly state to record the PFR. This resulted in the line maintenance stations not being aware of occurrence of similar problems. The line maintenance stations might repeat similar actions. None of the issues reported was identified as meeting the repetitive defect definition which would have triggered maintenance actions under the CMM requirements.
53. The available maintenance data record and analysis unable to identify repetitive defects and analyse their consequences.

Other findings

54. The DGCA audit process did not identify that the operator had not performed upset recovery training. Also, the audit process did not identify the inadequate maintenance processes relating to recurring faults.

3.2 Contributing factors²⁰

- The cracking of a solder joint of both channel A and B resulted in loss of electrical continuity and led to RTLU failure.
- The existing maintenance data analysis led to unresolved repetitive faults occurring with shorter intervals. The same fault occurred 4 times during the flight.
- The flight crew action to the first 3 faults in accordance with the ECAM messages. Following the fourth fault, the FDR recorded different signatures that were similar to the FAC CB's being reset resulting in electrical interruption to the FAC's.
- The electrical interruption to the FAC caused the autopilot to disengage and the flight control logic to change from Normal Law to Alternate Law, the rudder

²⁰“Contributing Factors” are those events in which alone, or in combination with others, resulted in injury or damage. This can be an act, omission, conditions, or circumstances if eliminated or avoided would have prevented the occurrence or would have mitigated the resulting injuries or damages.

deflecting 2° to the left resulting the aircraft rolling up to 54° angle of bank.

- Subsequent flight crew action leading to inability to control the aircraft in the Alternate Law resulted in the aircraft departing from the normal flight envelope and entering prolonged stall condition that was beyond the capability of the flight crew to recover.

4 SAFETY ACTION

4.1 Aircraft operator

As a result of this accident, the aircraft operator informed the KNKT of safety actions that they had taken.

At meetings between the aircraft operator and the KNKT, the operator advised that the safety actions had been generated from the preliminary recommendations that were published by the KNKT in the Preliminary Report.

In general, the safety actions covered several improvement plans for the flight operation relating to upset training, Safety Management System (SMS) and Crew Resource Management (CRM). Moreover, the operator had also provided several safety improvements for the maintenance aspects related to repetitive problems, Post Flight Report (PFR) as well the Trouble Shooting Manual (TSM).

The detail of the Safety Actions is attached in the Appendix 6.1 of this report. The summary of the Safety Actions is as follow:

1. 22 safety actions addressed the safety sensitive personnel and Aviation Security on the compliance to Standard Operating Procedures (SOP); integration enhancement for the Safety Management System implementation; Safety & Security Promotions through safety and security circulars and Flight Data Analysis statistic review; Human Factors development focusing on the communication enhancement and evidence Based CRM Training; Critical Incident Stress Management (CISM) training and campaign; Internal surveillance to the SOP compliance for pilots, flight attendants and Flight Operations Officers (FOO).
2. 11 safety actions on maintenance area addressed to all engineers at all stations especially on repetitive faulty report raised by the pilots when the engineers perform “Bite-Test” to the system computer; Bite test procedure review, and creation of a dedicated folder in server to save the printed copies of BITE Test and PFR; updating the flowchart procedures for repetitive defect handling and monitoring, AIRMAN system activation, assign aircraft custodian to monitor aircraft defect, and enhance engineer/technician skill and knowledge; optimum usage of IPC; optimum usage of AMM Task reference; Engineering and Maintenance Department planning on usage of Mobile devices such as iPad / Tablet devices, as a mobile Library which contain latest revision of AMM, IPC, TSM and SRM for every line maintenance stations for efficiency of handling during transit or maintenance activities; Requirement of Trouble Shooting Training for all certifying staff.
3. 18 safety actions on flight operations to address an enhancement program regarding significant weather phenomena through enhanced training for FOO, proactive action to visit BMKG office and establish cooperation and collaboration with BMKG, participate on the regional forum on meteorological services for aviation safety in South-east Asia, training on enhancement of weather radar usage for IAA pilots; Optimum flight plan weather data, and

include the aircraft defect performance penalties on flight planning stage; Review the SOP on pilot recruitment processes, including the Psychological/profiling test as part of pilot recruitment, review on the standard training timeframe and syllabus; review on the jet transition syllabus to fill any gap or lack of knowledge to operate Airbus A320, Upset Recovery and stall Recovery training, high altitude flying review, manual flying handling, Threat and error management, LOFT PPC and annual line check policy, Circuit Breaker policy; recording aircraft defect policy, Review on the A320 MEL update process, and Navigation: ISIS and Standby Compass should not be degraded during dispatch.

5 SAFETY RECOMMENDATIONS

While the KNKT acknowledges the safety actions taken by the aircraft operator, there still remain safety issues that need to be considered. The KNKT issues the following Safety Recommendations addressed to:

5.1 Aircraft Operator

1. The KNKT recommends that Indonesia AirAsia to re-emphasize the importance of the Standard Call-Outs in all phases of flight.
2. The KNKT recommends that Indonesia AirAsia to re-emphasize the taking over control procedure in various critical situations of flight.

5.2 Directorate General Civil Aviation

1. The KNKT recommends that the Directorate General Civil Aviation to ensure the implementation of air operators' training of flight crew is in accordance with the approved operations manual.
2. The KNKT recommends that the Directorate General Civil Aviation to ensure that air operators under CASR 121 conduct simulator upset recovery training in timely manner.
3. The KNKT recommends that the Directorate General Civil Aviation ensures that air operator maintenance system has the ability to detect and address all repetitive faults appropriately.

5.3 Aircraft Manufacturer

1. The KNKT recommends that Airbus to consider in developing a means for flight crews to effectively manage multiple and repetitive Master Caution alarms to reduce distraction.
2. The KNKT recommends that Airbus to consider and review the FCTM concerning the Standard Call-Outs in all phases of flight.

5.4 United States Federal Aviation Administration and European Aviation Safety Agency

1. The KNKT supports the previous French BEA recommendation (Recommendation FRAN-2015-024) on ensuring that future programs to include initial and recurrent training relating to taking over control of aircraft equipped with non-coupled control stick.
2. The KNKT recommend expediting the implementation of mandatory for upset recovery training earlier than 2019.

6 APPENDICES

6.1 Air Operator Safety Action

	Indonesia AirAsia Safety Actions as the follow-up to the NTSC Safety Recommendations <i>IAA Safety Actions Report_for internal circular and NTSC only</i>	Area : Safety & Security
		Date : 01 November 2015

1. Reminder to Safety Sensitive Persons & Avsec on the SOP compliance.

No	Safety Actions	Action Content	PiC	Evidence(s)	Status & Target Date
SS-1.1	E-mail notification to Pilots.	Intranet e-mail: "Operational Safety Reminder". 1. Thorough assessment of the threats at departure, enroute and arrival phases and apply mitigation as appropriate. 2. Review the icing operation procedure as per PRO-SUP-30 Ice and Rain Protection 3. Review OEB 48 Abnormal V-Alpha Prot.	SAG – Ft.Ops	1. Intranet e-mail date 28 Dec 2014 print-out. 2. Attachment on A320 FCOM: PRO-SUP-30. 3. Attachment on Airbus OEB-48.	Disseminated on 28 Dec 2014
SS-1.2	E-mail notification to Pilots	Intranet e-mail: "Operational Safety Notes". 1. Comply with the DGCA face-to-face briefing with FOO as part of preflight activities. 2. Arrival plan at the FLOPS to get sufficient time for better decision and not involve to the rush situation. 3. Have a robust system in SOP compliance, e.g. not to shortcut checklist reading. 4. In-flight weather avoidance up to 50 nm. 5. In a condition where Pilot require to consume medication, he/she must	SAG – Ft.Ops	1. Intranet e-mail date 4 Jan 2015 print-out. 2. Sample of "face-to-face briefing" list. 3. Attachment on COM 10.1.10 (Use of Prohibited Drugs & Medicines) and COM 10.1.19 (Uniforms).	Disseminated on 4 Jan 2015

	Indonesia AirAsia Safety Actions as the follow-up to the NTSC Safety Recommendations <i>IAA Safety Actions Report_for internal circular and NTSC only</i>	Area : Safety & Security
		Date : 01 November 2015

		consult to Balai Hatpen for the clearance and to notify OCC as early as possible. 6. Proper wearing of the Uniform.			
SS-1.3	E-mail notification to FOOs & Pilots	Intranet e-mail: "DGCA Adverse Weather Circular".	SAG – Flt.Ops	1. Intranet e-mail date 4 Jan 2015 print-out. 2. Attachment on "Edaran Keselamatan Adverse Weather Operation".	Disseminated on 4 Jan 2015
SS-1.4	Safety Circular to Pilots	Safety Circular "Weather Phenomena-ITCZ". Reminder for the weather phenomenon, the ITCZ – Inter Tropical Convergence Zone.	Corporate Safety	Safety Circular No: CSS/SC-001/2015.	Disseminated on 5 Jan 2015
SS-1.5	Safety Circular to Pilots	Safety Circular "Weather Radar – Storm Avoidance". Reminder for the Storm avoidance and the optimum usage of the weather radar.	Corporate Safety	1. Safety Circular No: CSS/SC-002/2015. 2. Airbus Flight Operation Briefing Notes – Optimum Use of the Weather Radar.	Disseminated on 5 Jan 2015
SS-1.6	Safety Circular to Pilots	Safety Circular "Cb – Cumulonimbus Cloud". Reminder for the weather phenomenon, the Cb – Cumulonimbus type of cloud.	Corporate Safety	Safety Circular No: CSS/SC-003/2015.	Disseminated on 5 Jan 2015
SS-1.7	E-mail notification to Pilots	Intranet e-mail: "Safety Reminder for Pilots". Encourage staff to make more reports especially on unstable approach and go-arounds. Other reports such as	Flight Safety	1. Intranet e-mail date 8 Jan 2015 print-out. 2. Attachment on A320 FCOM PRO-SUP-30 Ice and Rain Protection. 3. Attachment on Airbus OEB-48 ABNORMAL V ALPHA PROT. 4. Attachment on A320 FCTM SI-070 Use of Radar.	Disseminated on 8 Jan 2015

	Indonesia AirAsia Safety Actions as the follow-up to the NTSC Safety Recommendations <i>IAA Safety Actions Report_for internal circular and NTSC only</i>	Area : Safety & Security
		Date : 01 November 2015

		turbulence during flights or any suspected icing conditions/cabin safety.			
SS-1.8	Safety Circular to Pilots	Safety Circular "Airbus Golden Rules". Reminder for the basic philosophy of Airbus, the Golden Rules for Pilots.	Corporate Safety	1. Safety Circular No: CSS/SC-004/2015. 2. A320 FCTM – Operational Philosophy.	Disseminated on 8 Jan 2015
SS-1.9	E-mail notification to Pilots	Intranet e-mail: "Safety Reminder on Wake Turbulence".	Flight Safety	1. Intranet e-mail date 8 Jan 2015 print-out.	Disseminated on 8 Jan 2015
SS-1.10	Safety Circular to Pilots	Safety Circular "QZ8501 Post Accident Update". 1. Early preflight preparation. 2. Reminder on the "Walk-around" mandatory procedure. 3. Usage of MEL. 4. Enhancement on the CRM procedure. 5. Flight deck management. 6. Cockpit absence procedure. 7. ECAM handling.	SAG – Flt.Ops	Safety Circular No: CSS/SC-003/2015.	Disseminated on 3 Feb 2015

2. Integration enhancement for the SMS – Safety Management System implementation.

No	Safety Actions	Action Content	PIC	Evidence(s)	Status & Target Date
SS-2.1	SAG – Safety Action Group meeting.	Mutual discussion has agreed to enhance monthly SAG meeting to review daily operations, repetitive maintenance actions and hazard reports.	Corporate Safety	SAG Minutes of Meeting and List of Attendance of SAG member.	Implemented and will be a regular monthly review session.



Indonesia AirAsia Safety Actions as the follow-up to the NTSC Safety Recommendations

IAA Safety Actions Report_for internal circular and NTSC only

Area : Safety & Security

Date : 01 November 2015

SS-2.2	Data Collection and Keeping.	Data collection and keeping on previous repetitive maintenance actions issue and other operational hazard reports for further analysis.	Corporate Safety and Engineering SMS team	Sample of repetitive maintenance action records.	Implemented and will become a continuous process.
SS-2.3	SMS integrations.	To review and enhance the SMS – Safety Management System integration framework, by conducting SMS Training for all IAA Employee, start from the Top Management level.	Corporate Safety and Engineering SMS team	SMS Training syllabus.	Training syllabus has been defined. Already start on 26 October 2015 for 2 years period
SS-2.4	SAG – TechOpsSafety meeting	Monthly discussion has agreed to enhance normal daily operations and specific issues in relates with Engineering / Maintenance, Flight Operations, Ground Operations, Safety and Security.	Corporate Safety & Security	SAG Minutes of Meeting and List of Attendance of SAG member.	Implemented and will be a regular monthly review session.

	Indonesia AirAsia Safety Actions as the follow-up to the NTSC Safety Recommendations <i>IAA Safety Actions Report_for internal circular and NTSC only</i>	Area : Safety & Security
		Date : 01 November 2015

3. Safety & Security Promotions.

No	Safety Actions	Action Content	PIC	Evidence(s)	Status & Target Date
SS-3.1	Safety and Security Circulars	Internal Corporate Safety and Aviation Security Department website with safety and security awareness information that being uploaded for two monthly period.	Corporate Safety & Security	Last update on Circular production and CSS (Corporate Safety & Aviation Security) website content – April 2015 update.	Implemented and will be continuous program (two monthly review / update)
SS-3.2	FDA – Flight Data Analysis statistic review	Regular report / statistic review for Pilots on the Flight Data Analysis statistic and trends.	Corporate Safety & Security	Q1-2015 FDA statistic review for Pilots. Q3-2015 FDA statistic review for Pilots.	Implemented.

4. Human Factors development: Communications, Evidence Based for CRM.

No	Safety Actions	Action Content	PIC	Evidence(s)	Status & Target Date
SS-4.1	Human Factors development.	Collaborative project with Flight Operations Department focusing on the Communication enhancement and Evidence Based CRM Training.	Corporate Safety and Flight Operations	CRM course for Instructors syllabus and attendance list. CRM is a bridging tools for enhancing communication in CRM, by escalating the human behavioral (non-technical) aspect as part of CRM to be implemented within Operational procedure execution	Started on 26 October 2015. And will be collaborate with HUFAC development which still in-progress on developing the Project plan.

	Indonesia AirAsia Safety Actions as the follow-up to the NTSC Safety Recommendations <i>IAA Safety Actions Report_for internal circular and NTSC only</i>	Area : Safety & Security
		Date : 01 November 2015

5. CISM (Critical Incident Stress Management) training and campaign.

No	Safety Actions	Action Content	PIC	Evidence(s)	Status & Target Date
SS-5.1	Peer Support Program notification.	<ol style="list-style-type: none"> Assigned Expert Psychologist for crew's family. Assigned Psychologist for 8 SUB FAs. Shared to CEO's direct reports by Aviation Psychologist. Second Group Session PD in coordination with Safety to conduct CISM. 	Corporate Safety, Flight Operations, People Department	<ol style="list-style-type: none"> Intranet e-mail date 22 January 2015. 	Implemented.
SS-5.2	Peer Support Session and Critical Incident Stress Management (CISM) briefing.	Briefing to commence the Peer Support Session and Critical Incident Stress Management (CISM) program.	Corporate Safety, Flight Operations, People Department	<ol style="list-style-type: none"> Intranet e-mail date 23 January 2015. Certificate of CISM only available for Capt. Tri Hanggono, required others key person's certificate. Attendance list and syllabus of the training are required 	Implemented.
SS-5.3	CISM (Critical Incident Stress Management) training.	In-house training at RedHouse office for the CISM (Critical Incident Stress Management) agents, by certified instructors for assigned persons.	Corporate Safety, Flight Operations, People Department	<ol style="list-style-type: none"> Certificate copy for CISM agents. Attendance list. 	Conducted at 27-28 January 2015; will be continued for additional CISM agents.

	Indonesia AirAsia Safety Actions as the follow-up to the NTSC Safety Recommendations <i>IAA Safety Actions Report_for internal circular and NTSC only</i>	Area : Safety & Security
		Date : 01 November 2015

SS-5.4	Peer Support sessions at all IAA Hubs (SUB, CGK, BDO, KNO, DPS)	Peer Support sessions: a sharing session by each department employees, escorted by qualified instructor to discuss and share emotional / psychological aspects related to post incident / accident event.	Corporate Safety, Flight Operations, People Department	<ol style="list-style-type: none"> Attendance list Syllabus or MOM of the training Documented "output" from this training Intranet e-mail: CISM Agents (2 February 2015) Revision of CISM agent: <ol style="list-style-type: none"> Siska and Cut Kemala Fira for Red House Morizio for SUB Allstars Delvy for DPS, PKU and KNO Allstars Shanti Iriani for CGK, BDO and JOG Capt. Tri Hanggono for Pilots 	Conducted on February at all IAA Hubs: SUB, CGK, BDO, KNO and DPS; and will be followed to other stations.
--------	---	---	--	--	--

6. Surveillance 2015 planning and enhancement:

No	Safety Actions	Action Content	PIC	Evidence(s)	Status & Target Date
SS-6.1	a. Cockpit enroute (LOSA) b. Cabin enroute c. Station Facility	Internal surveillance to the SOP compliance for Pilots, Flight Attendants and FOOs, mainly at IAA Hubs. Documentation on surveillance planning and enhancement has been made.	Corporate Safety	<ol style="list-style-type: none"> LOSA – Line Operation Safety Audit forms. Cabin enroute surveillance forms. 	Implemented for LOSA and Cabin enroute. Station facility surveillance will start on June 2015.

	Indonesia AirAsia Safety Actions as the follow-up to the NTSC Safety Recommendations <i>IAA Safety Actions Report_for internal circular and NTSC only</i>	Area : Engineering
		Date : 1 November 2015

1. **Reminder and briefing for all Engineers at all Hubs and Stations, especially on repetitive fault report raised by Pilots but not “hard-on” when Engineer performing “Bite-Test” to the system computer.**

No	Safety Actions	Action Content	PiC	Evidence(s)	Status & Target Date
ME-1.1	Reminder and briefing for all Engineers at all Hubs and Stations for records of maintenance activity.	<p>Hubs and Stations visit for briefing to all Engineers that all of work done to the aircraft related to maintenance activity must be recorded into the MR1 and/or MR2 even though it's would not fix the problem/defect.</p> <p>Engineer should clear the Defect/Release the aircraft in refer to respective TSM and AMM task reference.</p> <p>Engineer should logged-in the MR-1 for every “Bite-Test” and “CB reset” with clear (satisfy) result for releasing the Aircraft.</p>	Maintenance Operation Manager (MOM); Maintenance Production Manager (MPM)	<ol style="list-style-type: none"> 1. Intranet e-mail: “Station Visit and Briefing” date 6 Feb 2015. 2. Attendance List. 3. Briefing pointer. 	Implemented, conducted on 2 Feb - 20 Mar 2015.

	Indonesia AirAsia Safety Actions as the follow-up to the NTSC Safety Recommendations <i>IAA Safety Actions Report_for internal circular and NTSC only</i>	Area : Engineering
		Date : 1 November 2015

2. Handling the Repetitive Fault Report by Pilots – “Bite-Test” procedure.

No	Safety Actions	Action Content	PiC	Evidence(s)	Status & Target Date
ME-2.1	“BITE Test ” procedure review	<p>Every BITE test being done as part of aircraft troubleshooting action must be printed and proper documented (include stated on the MR-1) for further review.</p> <p>All BITE Test result should be sent to e-mail: iaa_eng_pfr@airasia.com”.</p>	Maintenance Operation Manager (MOM); Maintenance Production Manager (MPM)	<ol style="list-style-type: none"> Quality Notice No. QN-G-059; April 2015. PFR Handling flow-charts. 	<p>Account has been created on 29 Jan 2015.</p> <p>Continuous action process will be managed and monitored by Maintenance Operation Control (MOC).</p>
ME-2.2	Create a dedicated folder in server to save the printed BITE test and PFR copy.	<p>Specific folders are created to keep the “BITE Test” print-out and PFR copy. These folders are available on every Hubs dedicated to the Aircraft availability and reported by local Engineer to MOC at CGK.</p>	Maintenance Operation Manager (MOM); Maintenance Production Manager (MPM)	<ol style="list-style-type: none"> Quality Notice No. QN-G-059; April 2015. PFR Handling flow-charts. 	Implemented.

	Indonesia AirAsia Safety Actions as the follow-up to the NTSC Safety Recommendations <i>IAA Safety Actions Report_for internal circular and NTSC only</i>	Area : Engineering
		Date : 02 November 2015

3. Handling the Repetitive Fault Report by Pilots – Fault Handling as per CMM and EPM procedure.

No	Safety Actions	Action Content	PIC	Evidence(s)	Status & Target Date
ME-3.1	Create update FLOWCHARTs procedure for repetitive defects handling and monitoring	Repetitive fault handling stated on CMM and EPM were reviewed and updated to accommodate the repetitive defects handling and monitoring, to give optimum mitigations and actions.	Maintenance Operation Manager (MOM); Maintenance Production Manager (MPM)	1. Quality Notice No. QN-G-059; April 2015. 2. PFR Handling flow-charts.	Implemented.
ME-3.2	“Real Time” aircraft fault monitoring	To activate “AIRMAN” monitoring system and continuous monitoring by MOC (Maintenance Operational Control).	Planning Technical Service Manager (PTM); Maintenance Operation Manager (MOM)	1. Aircraft Solution Line Service Agreement, dated 26 October 2015. 2. Aircraft Engineering Support Service Agreement, dated 30 January 2015	February 2016
ME-3.3	Assign Aircraft Custodian	Job assignment and role has been made for MOC team and Aircraft custodian. The following are action taken from MOC team:	Director of Maintenance and Engineering; Maintenance Operation	1. Internal Memo No. 82/MOM-IM/V/15, date 9 Mar 2015. 2. Sample of Defect Monitoring records.	Implemented. Continuous action process will be managed and



Indonesia AirAsia Safety Actions as the follow-up to the NTSC Safety Recommendations

IAA Safety Actions Report_for internal circular and NTSC only

Area : Engineering

Date : 02 November 2015

		<ol style="list-style-type: none"> To assign aircraft custodian to monitor aircraft defect. Defect monitoring, highlighting and provide trouble shooting advice as per A/C custodian. 	Manager (MOM); Maintenance Production Manager (MPM)		monitored by MOC
ME-3.4	Enhance Engineer/ technician skill and knowledge.	To assign Field Trainer and provide Basic instructor course for assigned Engineer, to be projected as Field Trainers for continuous training on all Hubs.	Director of Maintenance and Engineering; Maintenance Operation Manager (MOM); Maintenance Production Manager (MPM)	<ol style="list-style-type: none"> Basic Instructor Course attendance list. Basic Instructor Course Certificate (sample) 	Implemented, conducted on 21-24 April 2015.

4. Usage of IPC – Illustrative Parts Catalogue.

No	Safety Actions	Action Content	PiC	Evidence(s)	Status & Target Date
ME-4.1	Reminder and briefing for all Maintenance staff at all Hubs and Stations for the use of IPC.	Enhancement and awareness briefing/reminder to all maintenance staff for a careful and thorough in using	Maintenance Operation Manager (MOM);	<ol style="list-style-type: none"> Intranet e-mail: "Station Visit and Briefing" date 6 Feb 2015. Attendance List. Briefing pointer. 	Implemented. Has been conducted on 2 Feb - 20 Mar 2015.

	Indonesia AirAsia Safety Actions as the follow-up to the NTSC Safety Recommendations <i>IAA Safety Actions Report_for internal circular and NTSC only</i>	Area : Engineering
		Date : 02 November 2015

		IPC, especially for interchangeability and intermix-ability spare parts.	Maintenance Production Manager (MPM)		
--	--	--	--------------------------------------	--	--

5. Usage of AMM Task Reference.

No	Safety Actions	Action Content	PIC	Evidence(s)	Status & Target Date
ME-5.1	Reminder and briefing for all Maintenance staff at all Hubs and Stations for the use of AMM.	Enhancement and awareness briefing/reminder to all maintenance staff for a careful and thorough in using AMM Task Reference and recorded into MR1 and/or MR2. Task reference used and recorded into MR2 must be directly taken from AMM.	Maintenance Operation Manager (MOM); Maintenance Production Manager (MPM)	<ol style="list-style-type: none"> Intranet e-mail: "Station Visit and Briefing" date 6 Feb 2015. Attendance List. Briefing pointer. 	Implemented. Has been conducted on 2 Feb - 20 Mar 2015.

	Indonesia AirAsia Safety Actions as the follow-up to the NTSC Safety Recommendations <i>IAA Safety Actions Report_for internal circular and NTSC only</i>	Area : Engineering
		Date : 02 November 2015

6. Engineering and Maintenance Department planning on usage of Mobile devices such iPad / Tablet devices, as a mobile Library which contain latest revision of AMM, IPC, TSM and SRM for every Hubs, for efficiency handling during transit or maintenance activity.

No	Safety Actions	Action Content	PIC	Evidence(s)	Status & Target Date
ME-6.1	Usage of Mobile devices for document library tools; i.e. iPad / Tablet device.	To make sure that Task reference are readily available on site	Maintenance Operation Manager (MOM); Maintenance Production Manager (MPM) Planning and Technical Service Manager (PTSM)	Purchase Request No: 9139 Issued on 8 May 2015 Item Handover, dated 28 October 2015	Implemented on October 2015.

7. Requirement POT (Principle of Troubleshooting) for all certifying staff

No	Safety Actions	Action Content	PIC	Evidence(s)	Status & Target Date
ME-7.1	Principle of Trouble Shooting Training. Course title "A320 Basic Trouble Shooting"	Enhancement and awareness training to all maintenance staff for an appropriate and effective trouble shoot.	Director of Maintenance (DOM); Maintenance Operation Manager (MOM);	Syllabus. Attendance List	Implemented and an on-going process. Target: Within one year to



Indonesia AirAsia Safety Actions as the follow-up to the NTSC Safety Recommendations

IAA Safety Actions Report_for internal circular and NTSC only

Area : Engineering

Date : 02 November 2015

		To be a Certifying staff is Mandatory to take this course and For the current LAE will be associated during renewal process	Maintenance Production Manager (MPM); Quality Assurance Manager (QAM); Planning and Technical Service Manager (PTSM)		complete all certifying staff by January 2016.
--	--	--	--	--	--



Indonesia AirAsia Safety Actions as the follow-up to the NTSC Safety Recommendations

IAA Safety Actions Report_for internal circular and NTSC only

Area : Flight Operations

Date : 02 November 2015

1. Enhancement program on the significant weather phenomena.

No	Safety Actions	Action Content	PIC	Evidence(s)	Status & Target Date
FO-1.1	FOO – Flight Operation Officer enhancement training.	Enhancement training on the significant weather phenomena for dispatcher / FOOs, to have best flight planning and re-routing.	OCC Manager	Attendance List.	Implemented.
FO-1.2	Visit to BMKG Head Office.	Proactive action to visit BMKG Head Office, to establish cooperation and collaboration with BMKG management personnel. Technical discussion on the specific and significant weather information with BMKG Operation Center Room, to have better view and understanding.	Corporate Safety	1. IAA request letter.	Done, on 20 Feb 2015.
FO-1.3	Participate on the Regional Forum on Meteorological Services for Aviation Safety in Southeast Asia.	Proactive action to respond on the BMKG invitation to the Regional Forum on Meteorological Services for Aviation Safety in Southeast Asia.	Corporate Safety	1. Intranet e-mail from BMKG. 2. Invitation from BMKG. 3. Participant data.	Done, on 29 – 30 Apr 2015.



Indonesia AirAsia Safety Actions as the follow-up to the NTSC Safety Recommendation

IAA Safety Actions Report_for internal circular and NTSC only

Area : Flight Operations

Date : 02 November 2015

		Regional Forum is designed to identify and build cooperation and collaboration in aviation meteorology, includes <i>National Meteorological and Hydrological Services (NMHSs), Air Traffic Services, Airlines, Volcanology institutions from Regional Association II (Asia) and Regional Association V (South-West Pacific) WMO</i> to enhance aviation meteorological services and safety.			
FO-1.4	Optimum usage and understanding on Weather Radar system.	Training on the enhancement of Weather Radar usage by Rockwell Collins, for IAA Pilots.	Flight Operations	1. Intranet e-mail from Rockwell Collins. 2. Attendance List. 3. Weather Radar User Guide.	Done at 4-7 May 2015.

	Indonesia AirAsia Safety Actions as the follow-up to the NTSC Safety Recommendation <i>IAA Safety Actions Report_for internal circular and NTSC only</i>	Area : Flight Operations
		Date : 02 November 2015

2. Flight Planning and Dispatch.

No	Safety Actions	Action Content	PIC	Evidence(s)	Status & Target Date
FO-2.1	Optimum Flight Plan weather data.	In a condition where the en-route weather phenomena becoming marginal, the planning stage should collect the nearest and update weather information and data; i.e. 3 (three) hours prior to schedule time of departure.	OCC	Random CFP –Company Flight Plan data.	Implemented.
FO-2.2	Flight planning stage should include aircraft defect performance penalties.	<p>Coordination between Technical Service and Flight Operation to update any new procedure.</p> <p>Introduce the new ELAC L97 standard which should be followed by applying of OEB 46-No Engagement of Guidance Mode, as the replacement of OEB 38.</p>	OCC	<ol style="list-style-type: none"> 1. Reminders has been informed regarding Flight planning stage should include aircraft defect performance penalties. 2. Notification to Pilots regarding ELAC L97 procedure (FOC 1115 White OEB 46 Application dated May 13th 2015). 	<p>Implemented.</p> <p>Dissemination information 12 February 2015</p>

	Indonesia AirAsia Safety Actions as the follow-up to the NTSC Safety Recommendation <i>IAA Safety Actions Report_for internal circular and NTSC only</i>	Area : Flight Operations
		Date : 02 November 2015

3. Pilot Recruitment.

No	Safety Actions	Action Content	PIC	Evidence(s)	Status & Target Date
FO-3.1	To Review Pilot Recruitment processes: determination, guidance (SOP)	To review SOP on Pilot Recruitment (doc. No. IAA/FOP/SOP/01); submission of training and type rating record.	Flight Operations	In-Progress	June 2016
FO-3.2	To include the Psychological / Profiling test as part of pilot recruitment.	To review SOP on Pilot Recruitment (doc. No. IAA/FOP/SOP/01); Psychological / Profiling Test to be conducted as part of pilot recruitment.	Flight Operations	Revised SOP of Pilot Recruitment (Doc no. IAA/FOP/SOP/01).	June 2016
FO-3.3	Pilot management review on the standard training time frame and syllabus.	Review on the Operations Training Manual: Flight Crew Training Issue 04, Rev.03; the assurance of candidate achievement to the standard training time frame and syllabus.	Flight Operations	Updated Training time frame and syllabus on Operations Training Manual : Flight Crew Training Issue 04, Rev.03 Evidence: Management Control Training Record & Internal Memo After Release Line Training Policy	Implemented

	Indonesia AirAsia Safety Actions as the follow-up to the NTSC Safety Recommendation <i>IAA Safety Actions Report_for internal circular and NTSC only</i>	Area : Flight Operations
		Date : 02 November 2015

4. Pilot Training.

No	Safety Actions	Action Content	PIC	Evidence(s)	Status & Target Date
FO-4.1	Review on the Jet Transition syllabus to fill the gap lack of knowledge to operate Airbus A320.	<ol style="list-style-type: none"> Gap analysis to the new join pilot with the CPL background with no Jet experience flying. Entry Level Training (ELT) that consist of Jet Familiarization Training and/or Multi Crew Cooperation (MCC) Training. Review to the OTM – Flight Crew Training (9 April 2015, Issue 04 - Revision 03, Chapter 3, page 3.12). 	Flight Operations	<ol style="list-style-type: none"> “Airbus A320 ELT course including Jet Familiarization and Multi Crew MCC” training program. OTM – Flight Crew Training (9 April 2015, Issue 04 - Revision 03, Chapter 3, page 3.12). 	<p>Implemented for Action Point 1 & 2.</p> <p>Action 3 still In-progress. Target by January 2016</p>
FO-4.2	Upset Recovery and Stall Recovery Training.	<ul style="list-style-type: none"> Upset Recovery and Stall Recovery theory should be given as part of Type Qualification Ground Training. Upset Recovery and Stall Recovery training should be given on Type Qualification level. During every Recurrent Training: various Upset 	Flight Operations	<ul style="list-style-type: none"> Intranet e-mail: Airplane Upset Recovery – Training (15 Jan 2015) LOFT SPOT Revision 01 (21 Jan 2015) SPOT REV 01 (26 Jan 2015) Operation Training Manual – Special Training (9 April 2015, Issue 04 - Revision 03, Chapter 8, page 8.11. ICAO DOC 10011 Airplane Upset Recovery Training Aid (AURTA) REV 2 	<p>Implemented. On-going process.</p> <p>One dedicated simulator session for initial Upset Prevention & Recovery Training (UPRT) training starting 01 July 2015.</p>



Indonesia AirAsia Safety Actions as the follow-up to the NTSC Safety Recommendation

IAA Safety Actions Report_for internal circular and NTSC only

Area : Flight Operations

Date : 02 November 2015

		including Stall induced scenarios will be given with recovery procedures.		<ul style="list-style-type: none"> • OTM 8.11 Upset Recovery Training • AURTA TOT Capt. Darwansjah Toligi & Capt. Adjie Budi Santoso • Airbus Stall Recovery Training • Airbus Stall Training Video 	
FO-4.3	High Altitude flying review.	<ol style="list-style-type: none"> 1. Emphasize high altitude (above FL300) alternate and direct low degrading conditions to all pilot's training. E.g. Aircraft performance degraded to 4000 ft below max. Recommended altitude. 2. High level significant weather identification and avoidance training should be given to pilot. e.g. Temperature change to aircraft performance, weather radar usage. 	Flight Operations	<p>These exercises is under review for immediate implementation on SPOT and line operations.</p> <ol style="list-style-type: none"> 1. ICAO DOC 10011 2. Airplane Upset Recovery Training Aid (AURTA) REV 2 3. OTM 8.11 Upset Recovery Training 4. AURTA TOT Capt. Darwansjah Toligi & Capt. Adjie Budi Santoso 	<p>Implemented.</p> <p>Remarks: One dedicated simulator session for initial Upset Prevention & Recovery Training (UPRT) training.</p>
FO-4.4	Manual flying handling.	<ol style="list-style-type: none"> 1. Enhancement on the manual flying handling (Autopilot and Auto-Thrust OFF) had been introduced during line training at takeoff and approach phases with optimum of portion. 	Flight Operations	<p>These exercises is under review for immediate implementation on SPOT and line operations.</p> <p>Evidence:</p> <ol style="list-style-type: none"> 1. Line Operations: SOP Automation Policy 2. FCOM PRO-SUP-70:Use of ATHR In Approach 3. SOP: A/P & FD OFF During Vis App 	Implemented.

	Indonesia AirAsia Safety Actions as the follow-up to the NTSC Safety Recommendation <i>IAA Safety Actions Report_for internal circular and NTSC only</i>	Area : Flight Operations
		Date : 02 November 2015

		2. Manual flying (Autopilot and Auto-Thrust OFF) to be introduced during LOFT or Coft with optimum of portion.		4. CoFT & LOFT syllabus	
FO 4.5	TEM – Threat and Error Management	<ol style="list-style-type: none"> 1. Enhancement on TEM concepts. 2. Review on the Undesired Aircraft States condition. 3. TEM as safety analysis tool and key safety management points. 4. Learning from Failure. 	Flight Operations	<ol style="list-style-type: none"> 1. TEM-LOSA training slides. 2. TEM-LOSA training attendance list. 	Implemented.

5. FOC – Flight Operations Circular.

No	Safety Actions	Action Content	PIC	Evidence(s)	Status & Target Date
FO-5.1	LOFT, PPC, Annual Line Check Policy	Starting May, 2015: <ol style="list-style-type: none"> 1. First Officer will undergo LOFT and PPC every 6 months in an aircraft simulator. 2. First Officer will undergo Annual Line Check every 12 months in an aircraft. This supersedes COM Second in Command qualifications.	Flight Operations	FOC 0515 LOFT, PPC, Annual Line Check Policy dated March 23 rd 2015.	Implemented.



Indonesia AirAsia Safety Actions as the follow-up to the NTSC Safety Recommendation

IAA Safety Actions Report_for internal circular and NTSC only

Area : Flight Operations

Date : 02 November 2015

FO-5.2	Circuit Breakers Policy	<p>1. A tripped circuit breaker must not be reset unless the procedure is clearly defined in the QRH:</p> <p>1.a. In-flight: A circuit breaker may be reset once if the PIC judges that situation resulting from tripped circuit breaker has an adverse impact on flight safety,</p> <p>1.b. On the ground:</p> <p>a. A tripped circuit breaker must not be reset unless the action is coordinated with the Maintenance Team and the cause of the tripping circuit breaker has been identified.</p> <p>b. Cycling circuit breaker to restore malfunctioning system should be coordinated with the Maintenance Team.</p> <p>Aircraft must be stationary with the parking brake set during the reset.</p>	Flight Operations	FOC 1215 Circuit Breakers Policy dated May 22 nd 2015.	Implemented.
--------	-------------------------	--	-------------------	---	--------------



Indonesia AirAsia Safety Actions as the follow-up to the NTSC Safety Recommendation

IAA Safety Actions Report_for internal circular and NTSC only

Area : Flight Operations

Date : 02 November 2015

FO-5.3	Recording Aircraft Defect Policy	<p>A reminder that PIC must ensure MR1/Tech Log entry is completed after flight as per COM 1.4.2 E.</p> <p>Any aircraft defect must be recorded in the MR1/Tech Log according to the following:</p> <ol style="list-style-type: none"> 1. ECAM Warning Message. 2. Defect recorded on the PFR (see attachment). 3. Other defect that in PIC judgement will adversely affect flight safety. 	Flight Operations	FOC 1415 Recording Aircraft Defect Policy dated June 4 th 2015.	Implemented.
--------	----------------------------------	---	-------------------	--	--------------

	Indonesia AirAsia Safety Actions as the follow-up to the NTSC Safety Recommendation <i>IAA Safety Actions Report_for internal circular and NTSC only</i>	Area : Flight Operations
		Date : 02 November 2015

6. MEL - Minimum Equipment List.

No	Safety Actions	Action Content	PiC	Evidence(s)	Status & Target Date
FO-6.1	Review on the A320 MEL – Minimum Equipment List update process.	<ol style="list-style-type: none"> A320 MEL update process should be reviewed by Flight Operation and Engineering / Maintenance Departments. Navigation: ISIS and Standby Compass should not be degraded during dispatch. 	Flight Operations	<ol style="list-style-type: none"> In-progress. MEL 34-22 & 34-23. 	In-progress. End of January 2016.

6.2 Operation Training Manual: upset recovery training

	OPERATIONS TRAINING MANUAL CHAPTER 8 SPECIAL TRAINING	<table><tr><td>Issue Date</td><td>02 Dec 2013</td></tr><tr><td>Issue 4</td><td>Rev 00</td></tr><tr><td>Chapter</td><td>8</td></tr><tr><td>Page</td><td>23</td></tr></table>	Issue Date	02 Dec 2013	Issue 4	Rev 00	Chapter	8	Page	23
Issue Date	02 Dec 2013									
Issue 4	Rev 00									
Chapter	8									
Page	23									

8.11 UPSET RECOVERY

8.11.1 OBJECTIVE

Upon successful completion of training the trainee will be capable satisfactorily develop knowledge and ability for preventing and coping of aircraft upset.

8.11.2 APPLICABILITY

Upset Recovery Training is intended for Flight Crew.

8.11.3 MODULES

1. Ground Training

- A. Background
- B. Definitions
- C. Causes of Aircraft Upset
- D. Aerodynamic & Aircraft Systems in relation with aircraft upset
- E. Recovery methods by considering various aircraft attitude and speed
- F. Post upset conditions

2. Simulator

- A. **Flight Training (included malfunctions)**
Practicing Nose High, Nose Low and High Bank Angle Recovery
- B. **Debriefing**
An adequate post-flight critique will be accomplished.



Jacques ROSAY
VP Chief Test Pilot

What is stall? How a pilot should react in front of a stall situation

1. Introduction

The worldwide air transport fleet has recently encountered a number of stall events, which indicate that this phenomenon may not be properly understood and managed in the aviation community. As a consequence, the main aircraft manufacturers have agreed together to amend their stall procedures and to reinforce the training. A working group gathering Authorities and aircraft manufacturers will publish recommendations for harmonized procedures and appropriate training. This article aims at reminding the aerodynamic phenomenon associated to the stall, and the recently published new procedures.

2. The lift

A wing generates a lift equal to $1/2\rho S V^2 C_l$.

With:

ρ = air density

S = wing surface reference

V = True Air Speed

C_l = lift coefficient of the wing

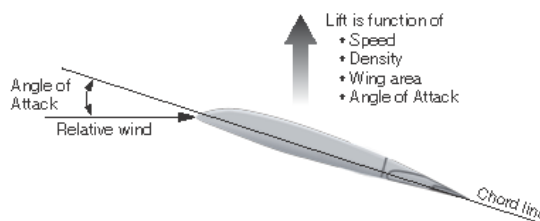

The lift coefficient increases as a function of the Angle of Attack (AoA) up to a value, called Maximum lift, where it starts to decrease.

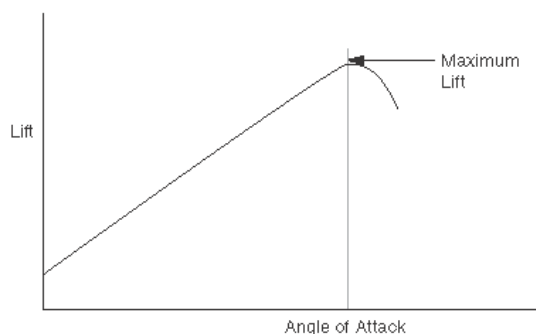

For a given configuration, a given speed and a given altitude, the lift is only linked to the AoA.

3. The stall phenomenon

The linear part of the curve corresponds to a steady airflow around the wing.

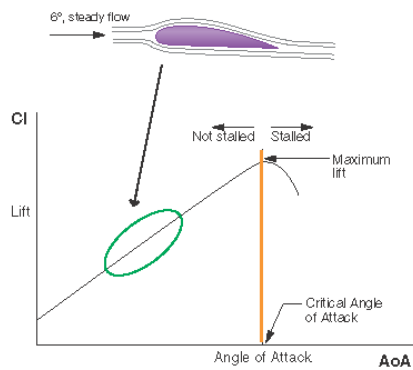

When the AoA reaches the value of the maximum CL, the airflow starts to separate.

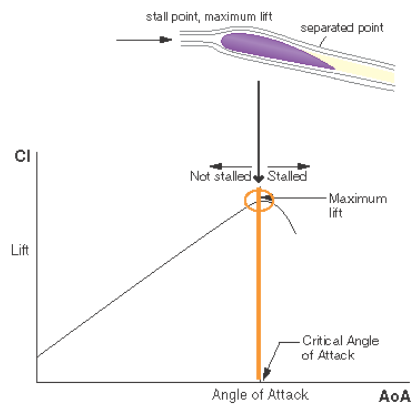

Beyond this point, the lift decreases as the flow is separated from the wing profile. The wing is stalled.

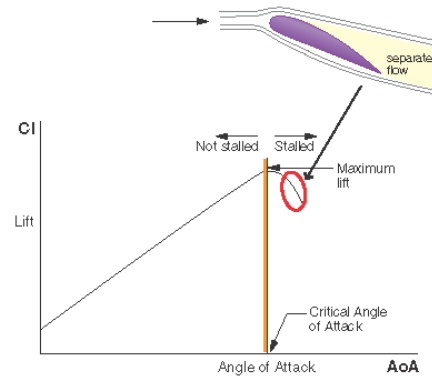

On this picture (extracted from a video footage), the erratic positions of the flow cones on this A380 wing during a stall test show that the flow is separated.

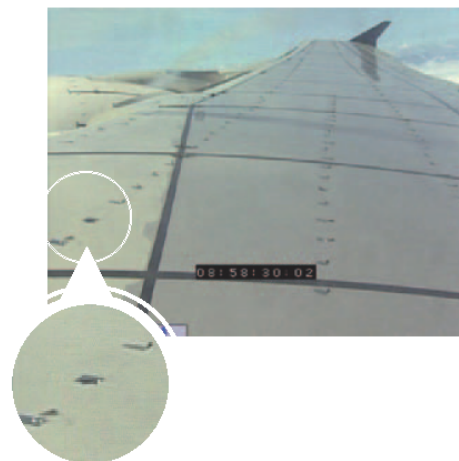

4. Some important things to remember about the stall

► For a given configuration and at a given Mach number, a wing stalls at a given Angle of Attack (AoA) called AoA STALL. When the Mach number increases, the value of the AoA STALL decreases.

► When approaching the AoA STALL, the wing generates a certain level of buffeting, which tends to increase in level at high Mach number.

► When the AoA increases and approaches the AoA STALL, in certain cases, a phenomenon of pitch up occurs as a result of a change in the distribution of the lift along the wingspan. The effect of the pitch up is a self-tendency of the aircraft to increase its Angle of Attack without further inputs on the elevators. Generally, for a given wing, this phenomenon occurs at a lower Angle of Attack and is more prominent when the Mach number is higher.

► The only mean to counter the pitch up is to apply a nose down elevator input.

► When the aerodynamic flow on the wing is stalled, the only possible mean to recover a normal flow regime is to decrease the AoA at a value lower than the AoA STALL.

► Stall is an AoA problem only. It is NOT directly a speed issue.

Knowing those two last characteristics is absolutely paramount, as they dictate the only possible way to get out of a stall.

5. Protections against the stall in NORMAL LAW on FBW aircraft

In NORMAL LAW, the Electronic Flight Controls System (EFCS) takes into account the actual AoA and limits it to a value (AoA MAX) lower than AoA STALL (fig. 1).

Figure 1
In NORMAL LAW, the EFCS limits the AoA to a value lower than AoA STALL.

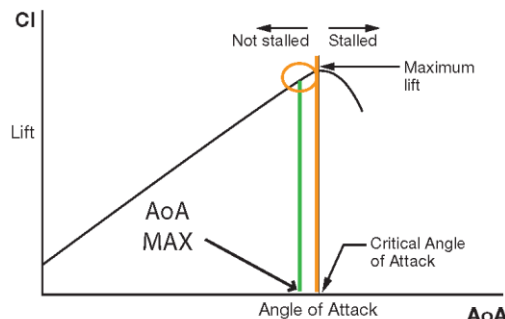

Figure 2
In ALTERNATE and DIRECT LAW, the aural Stall Warning is set at a value lower than AoA STALL.



The EFCS adjusts the AoA MAX limitation to account for the reduction of the AoA STALL with increasing Mach number.

Equally, for a given Mach number and a given AoA, the EFCS takes into account the natural pitch up effect of the wing for this Mach number and this AoA, and applies on the elevators the appropriate longitudinal pre-command to counter its effect.

6. Protections against the stall in ALTERNATE and DIRECT LAW on FBW and conventional aircraft

On FBW aircraft, following certain malfunctions, in particular in case of sensor or computer failure, the flight controls cannot ensure

the protections against the stall. Depending on the nature of the failure, they revert to ALTERNATE LAW or to DIRECT LAW.

In both cases, the pilot has to ensure the protection against the stall, based upon the aural Stall Warning (SW), or a strong buffeting which, if encountered, is an indication of an incipient stall condition.

The conventional aircraft are permanently in DIRECT LAW, and regarding the stall protection, they are in the same situation as the FBW aircraft in DIRECT LAW.

In both ALTERNATE and DIRECT LAW, the aural SW is set at a value called AoA Stall Warning (AoA SW), which is lower than the AoA STALL (fig. 2).

The triggering of the Stall Warning just means that the AoA has reached the AoA SW, which is by definition lower than the AoA STALL, and that the AoA has to be reduced.

Knowing what the SW is, there is no reason to overreact to its triggering. It is absolutely essential for the pilots to know that the onset of the aural Stall Warning does not mean that the aircraft is stalling, that there is no reason to be scared, and that just a gentle and smooth reaction is needed.

The value of the AoA SW depends on the Mach number. At high Mach number, the AoA SW is set at a value such that the warning occurs just before encountering the pitch up effect and the buffeting.

If the anemometric information used to set the AoA SW is erroneous, the SW will not sound at the proper AoA. In that case, as mentioned above, the clue indicating the approach of the stall is the strong buffeting. In the remainder of this document, for this situation, "SW" must be read as "strong buffeting".

7. Margin to the Stall Warning in cruise at high Mach number and high altitude

Typically, in cruise at high Mach number and high altitude, at or close to the maximum recommended FL, there is a small margin between the actual cruise AoA and the AoA STALL. Hence, in ALTERNATE or DIRECT LAW, the margin with the AoA SW is even smaller.

The encounter of turbulence induces quick variations of the AoA. As a consequence, when the aircraft is flying close to the maximum recommended altitude, it is not unlikely that turbulence might induce temporary peaks of AoA going beyond the value of the AoA SW leading to intermittent onsets of aural SW.

Equally, in similar high FL cruise conditions, in particular at turbulence speed, if the pilot makes significant longitudinal inputs, it is not unlikely that it reaches the AoA SW value.

For those reasons, when in ALTERNATE or DIRECT LAW, it is recommended to fly at a cruise flight level lower than the maximum recommended. A 4,000 ft margin is to be considered. Then, for the same cruise Mach number, the IAS will be higher, the AoA will be lower, and therefore the AoA margin towards AoA SW will be significantly increased.

In addition, as in RVSM space the use of the AP is mandatory, any failures leading to the loss of the AP mandates to descend below the RVSM vertical limit.

8. Stall Warning and stall

The traditional approach to stall training consisted in a controlled deceleration to the Stall Warning, followed by a power recovery with minimum altitude loss.

Experience shows that if the pilot is determined to maintain the altitude, this procedure may lead to the stall.

A practical exercise done in flight in DIRECT LAW on an A340-600 and well reproduced in the simulator consists in performing a low altitude level flight deceleration at idle until the SW is triggered, and then to push the THR levers to TOGA while continuing to pull on the stick in order to maintain the altitude.

The results of such a manoeuvre are:

- In clean configuration, even if the pilot reacts immediately to the SW by commanding TOGA, when the thrust actually reaches TOGA (20 seconds later), the aircraft stalls.

- In approach configuration, if the pilot reacts immediately to the SW, the aircraft reaches AoA stall -2° .

- In approach configuration, if the pilot reacts with a delay of 2 seconds to the SW, the aircraft stalls.

This shows that increasing the thrust at the SW in order to increase the speed and hence to decrease the AOA is not the proper reaction in

many cases (this will be developed in the following chapter).

In addition, it is to be noticed that, at high altitude, the effect of the thrust increase on the speed rise is very slow, so that the phenomenon described above for the clean configuration is exacerbated.

Obviously, such a procedure leads to potentially unrecoverable situations if it is applied once the aircraft has reached the aerodynamic stall (see next chapter).

Even if the traditional procedure can work in certain conditions if the pilot reacts immediately to the SW, or if he is not too adamant on keeping the altitude, the major issue comes from the fact that once the Stall Warning threshold has been crossed, it is difficult to know if the aircraft is still approaching to stall or already stalled. Difference between an approach to stall and an actual stall is not easy to determine, even for specialists.

Several accidents happened where the "approach to stall" procedure was applied when the aircraft was actually stalled.

For those reasons, the pilots should react the same way for both "approach to stall" and "stall" situations.

9. How to react

What is paramount is to decrease the AoA. This is obtained directly by decreasing the pitch order.

The pitch control is a direct AoA command (fig. 3).

The AoA decrease may be obtained indirectly by increasing the speed, but adding thrust in order to increase the speed leads to an initial adverse longitudinal effect, which tends to increase further the AoA (fig. 4).

It is important to know that if such a thrust increase was applied when the aircraft is already stalled, the longitudinal effect would bring the aircraft further into the stall, to a situation possibly unrecoverable.

Conversely, the first effect of reducing the thrust is to reduce the AoA (fig. 5).

Figure 3
Pitch control is a direct AoA command

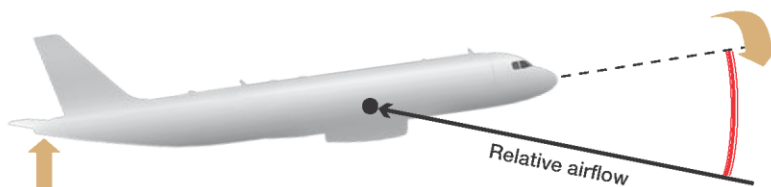

Figure 4
Adding thrust leads to an increase in AoA

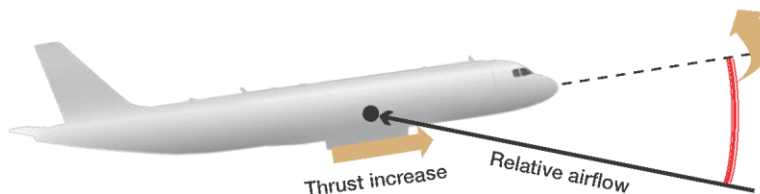
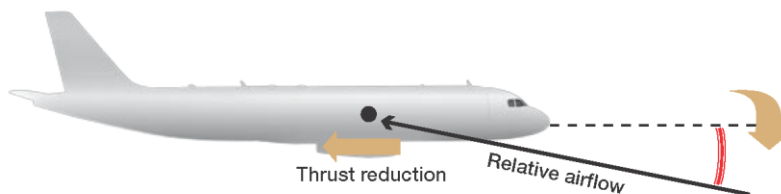

Figure 5
Reducing thrust leads to a decrease in AoA



In summary:

FIRST: The AoA MUST BE REDUCED. If anything, release the back pressure on stick or column and apply a nose down pitch input until out of stall (no longer have stall indications). In certain cases, an action in the same direction on the longitudinal trim may be needed. Don't forget that thrust has an adverse effect on AoA for aircraft with engines below the wings.

SECOND: When the stall clues have disappeared, increase the speed if needed. Progressively increase the thrust with care, due to the thrust pitch effect.

In practice, in straight flight without stick input, the first reaction when the SW is triggered should be

to gently push on the stick so as to decrease the pitch attitude by about two or three degrees in order to decrease the AoA below the AoA SW.

During manoeuvres, the reduction of the AoA is generally obtained just by releasing the backpressure on the stick; applying a progressive forward stick inputs ensures a quicker reduction of the AoA.

If the SW situation occurs with high thrust, in addition to the stick reaction, reducing the thrust may be necessary.

10. Procedure

As an answer to the stall situation, a working group gathering the FAA and the main aircraft manufacturers, including Airbus, ATR, Boeing, Bombardier and Embraer, have established a new generic procedure titled "Stall Warning or Aerodynamic Stall Recovery Procedure" applicable to all aircraft types.

This generic procedure will be published as an annex to the FAA AC 120.

This new procedure has been established in the following spirit:

- ▶ One single procedure to cover ALL stall conditions
- ▶ Get rid of TOGA as first action
- ▶ Focus on AoA reduction.

**Generic Stall Warning or
Aerodynamic Stall Recovery Procedure**

Immediately do the following at the first indication of stall (buffet, stick shaker, stick pusher, or aural or visual indication) during any flight phases *except at lift off*.

1. Autopilot and autothrottle..... Disconnect

Rationale: While maintaining the attitude of the aircraft, disconnect the autopilot and autothrottle. Ensure the pitch attitude does not change adversely when disconnecting the autopilot. This may be very important in mis-trim situations. Manual control is essential to recovery in all situations. Leaving one or the other connected may result in in-advertent changes or adjustments that may not be easily recognized or appropriate, especially during high workload situations.

2. a) Nose down pitch control... Apply until out of stall (no longer have stall indications)

b) Nose down pitch trim..... As needed

Rationale: a) The priority is reducing the angle of attack.

There have been numerous situations where flight crews did not prioritize this and instead prioritized power and maintaining altitude. This will also address autopilot induced full back trim.

b) If the control column does not provide the needed response, stabilizer trim may be necessary. However, excessive use of trim can aggravate the condition, or may result in loss of control or in high structural loads.

3. Bank..... Wings Level

Rationale: This orientates the lift vector for recovery.

4. Thrust.....As Needed

Rationale: During a stall recovery, many times maximum power is not needed. When stalling, the thrust can be at idle or at high thrust, typically at high altitude. Therefore, the thrust is to be adjusted accordingly during the recovery. For engines installed below the wing, applying maximum thrust can create a strong nose up pitching moment, if speed is low. For aircraft with engines mounted above the wings, thrust application creates a helpful pitch down tendency. For propeller driven aircraft, thrust application energizes the air flow around the wing, assisting in stall recovery.

5. Speed Brakes..... Retract

Rationale: This will improve lift and stall margin.

6. Bank..... Wings Level

Rationale: Apply gentle action for recovery to avoid secondary stalls then return to desired flight path.

Revision of Airbus' Operational documentation

Airbus has updated its operational documentation in order to reflect the changes introduced by the new generic stall recovery procedures. In order to allow simultaneous fleetwide introduction, the procedure was provided via Temporary Revision. This information was provided together with an FCTM update advance copy and FOT 999.0044/10, on May 12, 2010.

A300:

A300 FCOM volume 8GE Temporary Revision number 219-1
A300 FCOM volume 8PW Temporary Revision number 051-1
A300 QRH Temporary Revision number 076-1

A300FFCC:

A300FFCC FCOM volume 2 Temporary Revision number 052-1
A300FFCC QRH Temporary Revision number 025-1

A300-600/A300-600F:

A300-600/A300-600F FCOM volume 2 Temporary Revision number 002-2
A300-600/A300-600F QRH Temporary Revision number 217-1

A310:

A310 FCOM volume 2 Temporary Revision number 004-2
A310 QRH Temporary Revision number 224-1

A318/319/320/321:

FCOM volume 3 Temporary Revision number 323-1
QRH Temporary Revision number 727-1

A330:

FCOM volume 3 Temporary Revision number 552-1
QRH Temporary Revision number 353-1

A340:

FCOM volume 3 Temporary Revision number 512-1 (A340-200/-300)
FCOM volume 3 Temporary Revision number 513-1 (A340-500/-600)
QRH Temporary Revision number 369-1

A380:

FCOM Procedures / Non-ECAM Abnormal and Emergency Procedures / Operating Techniques

6.4 Upset Recovery Industry Team

November 2008

To: Nicholas A. Sabatini
Associate Administrator for Aviation Safety
AVS-1
800 Independence Avenue, SW
FOB 10-A, Room 1000 West
Washington, DC 20591

cc: Dan Jenkins
Manager, Air Carrier Training Branch
AFS-210
800 Independence Avenue, SW
FOB 10-A, Room 831
Washington, DC 20591

cc: Greg Kirkland
Acting Manager, Air Transportation Division
AFS-200
800 Independence Avenue, SW
FOB 10-A, Room 831
Washington, DC 20591

cc: Gloria LaRoche
Aviation Safety Inspector
Air Carrier Training, AFS-210
800 Independence Avenue, SW
FOB 10-A, Room 831
Washington, DC 20591

Dear Mr. Sabatini:

We are pleased to provide you this "Airplane Upset Recovery Training Aid Revision 2". This document was developed in response to FAA request for us to convene an industry and government working group to develop guidance to flight crews as it pertains to issues associated with operations, unintentional slowdowns, and recoveries in the high altitude environment. In the interest of defining an effective document, it has been decided to introduce this package as a supplement to the Airplane Upset Recovery Training Aid first released in 1998. While the Airplane Upset Recovery Training Aid specifically addressed airplanes with 100 seats or greater, the information in this supplement is directly applicable to most jet airplanes that routinely operate in this environment. This supplemental information has been inserted in the Airplane Upset Recovery Training Aid Rev 2 completed October 2008.

As a group of industry experts, we are confident we achieved the goal of defining a reference that will be effective to educate pilots so they have the knowledge and skill to adequately operate their airplanes and prevent upsets in a high altitude environment. The key point is that no reference material published is of value unless it is used. To that end, we implore the FAA to produce language to support implementation of this material that will motivate operators to use it. Indeed, the current Airplane Upset Recovery Training Aid serves as an excellent example of a collaborative reference produced at the insistence of the FAA, with little endorsement or requirement for implementation. The industry result is an assortment of products available with no standard reference. This competes against the very motivation for producing a collaborative document in the first place.

Several recommendations have been provided to our team from the FAA certification group. We are encouraged they continue to look at ways to improve future aircraft. We are confident this supplement and the Airplane Upset Recovery Training Aid, for airplanes in service today, are effective references, if implemented, to provide flight crews information and skills that respond to the suggestions this FAA group are studying.

Your review and agreement to the attached Training Aid will allow us to produce and deliver it to industry.

Sincerely,



Captain Dave Carbaugh
The Boeing Company
Co-chair Upset Recovery Industry Team



Captain Larry Rockliff
Airbus
Co-chair Upset Recovery Industry Team



Bob Vandel
Flight Safety Foundation
Co-chair Upset Recovery Industry Team

6.5 Airbus Upset Recovery Training

CUSTOMER SERVICES DIRECTORATE
1 Rond Point Maurice Bellonte
31707 Blagnac Cedex France
TELEPHONE + 33 (0)5 61 93 33 33



OPERATIONS TRAINING TRANSMISSION - OTT

TO: All A318,A319,A320,A321,A330,A340,A340-500,A340-600,A350,A380 Operators

SUBJECT: Use of FSTD's for Upset Recovery Training

OUR REF.: 999.0028/15 dated 10 March 2015

APPLICABLE AIRCRAFT: This OTT is applicable to A318, A319, A320, A321, A330, A340, A340-500, A340-600, A350, and A380

Notice: This OTT provides recommendations on training techniques, procedures or programs to operators. These training recommendations aim at enhancing efficiency or safety of operations. It is each Operator's responsibility to use the information contained in this OTT for application of the training recommendations described herein.

1. PURPOSE

This document is intended to guide operators and Approved Training Organisations (ATO's) in the conduct of Upset Prevention and Recovery Training (UPRT). Further documents are under development by Airbus and will be released in due course. The scope of this document to address UPRT conducted in a Flight Simulation Training Device (FSTD) qualified for the purpose, during type rating and recurrent training.

2. DESCRIPTION

The FSTD environment should only be used where appropriate and within the defined simulation envelope, as follows:

3. UPSET RECOVERY TRAINING - GENERAL

- a. The Definition of Upset is generally agreed to be a pitch in excess of +25° or -10° or a bank angle greater than 45° or an undesired speed.
- b. Pilots are reminded that in Normal Law, with the sidestick is in the neutral position, vertical and lateral disturbances will be resisted by the control laws. Without any pilot input, the flight controls will deflect surfaces to return the aircraft to a steady state of 1g with a zero roll rate. Therefore, it is extremely unlikely that the airplane will experience an upset in pitch or roll whilst in normal law.
- c. During a standard transition course, Airbus recommends that each pilot should experience the envelope protections in Normal Law along with high and low speed events, beyond the definition of Upset (see a) and up to the maximum permitted pitch attitude (+30° and -15°) and bank angle (67°). As a comparison, these exercises should be repeated with different configurations. Where appropriate, these exercises should be practiced in Alternate and Direct laws with respect of the limits of the definition of Upset (see a).

OPERATIONS TRAINING TRANSMISSION - OTT

- d. For any other Upset scenario, Airbus recommends instructor led exercises, firstly in Normal Law, followed by Alternate and then Direct Law. All manoeuvring should be contained within the constraints of the Normal Law protected envelope, even when manoeuvring in Alternate or Direct Law. Typically, Airbus recommends that pitch manoeuvres do not to exceed 25° nose up, 10° nose down or 45° of bank. The instructor should manoeuvre the aircraft into an upset situation, handing control to the trainee for the return to normal flight conditions. The emphasis of training in this area should be threefold:
 - i. To demonstrate the capability of the aircraft in Normal Law, to stabilize from divergences without pilot input.
 - ii. To compare the response of the aircraft in pitch and then roll in all 3 control laws.
 - iii. To enable the trainee to recognize a situation and recover to normal flight conditions, e.g. during an unexpected go around manoeuvre, which should only be flown in Normal Law and can be an effective demonstration of pitch protections.
- e. Airbus does not recommend exaggerated manoeuvres in Alternate or Direct Law that assume no intervention until the simulator is in an extreme attitude and energy state.
- f. Airbus notes that some simulators include IOS generated upset scenarios. Airbus has not evaluated any of these scenarios. Where the scenario conditions involve an uncontrollable divergence which the pilot(s) are unable to immediately arrest, an unacceptable level of negative training exists, to which Airbus is opposed. These IOS upset scenarios should not be used, the preference being as (d) above.

4. UPSET RECOVERY TRAINING - STALL RECOVERY

- a. This should be done with the aircraft configured in alternate or direct law as applicable. Without exception, trainees should be taught to recover at the first indication of a stall and follow the universally agreed recovery technique – see applicable FCOM. The first indication of a stall could be any or all of the following:
 - 1. Stall Warning Audio
 - 2. Buffeting, this could be heavy at times.
 - 3. A lack of pitch authority.
 - 4. A lack of roll control.
 - 5. Inability to arrest descent rate.
- b. To be consistent with the simulator data package provided, training in this area should be initiated with the simulator in approximately level flight, with a rate of deceleration towards the stall of approximately 1kt per second. If an operator or ATO has a requirement for an exercise where the stall recovery is delayed beyond the first indication of stall, Airbus recommends an instructor-led demonstration only.
- c. In the event of concerns over buffet modelling or concerns about stall characteristics, customers are encouraged to raise a Service Request in the RM Online tool at the Airbus Portal, or to contact their GO5 focal point, in order to receive support:

<mailto:ego5.support@airbus.com>



OPERATIONS TRAINING TRANSMISSION - OTT

Please submit questions about the operational content of this OTT to:

Capt. David OWENS
Flight Operations & Training Support
Phone: +33 (0)5 67 19 87 60
Fax number: +33 (0)5 61 93 29 68
E-mail: <mailto:flightcrew.training-policy@airbus.com>

Best regards

Capt. Dominique DESCHAMPS
Vice President Flight Operations & Training Support

6.6 Airbus A320 Type Qualification Training-Handling Phase FFS 4

 AIRBUS <small>TRAINING AND FLIGHT OPERATIONS SUPPORT AND SERVICES</small> A320 FLIGHT CREW TRAINING PROGRAM	STANDARD COURSE HANDLING PHASE	E F2S 02.04 FFS 4 Page 1
		Issue 11 JAN 2014

FFS 4 - TRAINEE 2

WEATHER	
LFZZ 36012KT 5000 OVC008 12/10 Q1010	
FLIGHT DATA	
FLT NBR [Airline ID] 204	
FROM LFZZ	TO LFZZ
ALTN LFLL	
CO RTE AIBAIB1	ALTN / CO RTE AIBLYS
CRZ FL FL 070	CRZ TEMP -1°C
CI 30	TROPO 36090
TRIP WIND -	TRIP DIST 92 Nm
FUEL & LOAD	
ZFW 54 t 118 800 lb	ZFWCG 32.7 %
FOB 11 t 24 200 lb	GW 65 t 143 000 lb
NOTES	
RWY COND DRY FPLN : Refer Co-route AIR COND ON ANTI ICE OFF	

PERF PAGE		PERF PAGE	
LFZZ 33R			
V1 <input type="text"/> <input type="text"/> TOGA		V1 <input type="text"/> <input type="text"/> TOGA	
VR <input type="text"/> <input type="text"/> FLEX		VR <input type="text"/> <input type="text"/> FLEX	
V2 <input type="text"/>		V2 <input type="text"/>	
FLAPS <input type="text"/>		FLAPS <input type="text"/>	
PERF PAGE		PERF PAGE	
V1 <input type="text"/> <input type="text"/> TOGA		V1 <input type="text"/> <input type="text"/> TOGA	
VR <input type="text"/> <input type="text"/> FLEX		VR <input type="text"/> <input type="text"/> FLEX	
V2 <input type="text"/>		V2 <input type="text"/>	
FLAPS <input type="text"/>		FLAPS <input type="text"/>	

Time	EVENTS	AP	FD	ATHR	TRK-FPA
	INIT HOLDING POINT - LFZZ 33R				
	1 - TAKE OFF WINDSHEAR		V	V	
	2 - CLIMB ADR1 FAULT	V	V	V	
	3 - CRUISE FL 070	V	V	V	
	4 - ADR2 FAULT				V
	5 - ALTERNATE LAW - STALL RECOVERY				V
	6 - DESCENT				V
	7 - STALL RECOVERY AT LOW ALTITUDE				V
	8 - ILS RWY 33R - RAW DATA - ALTN LAW				V
0:45	9 - LANDING				
	INIT FL 350 - IMC - FOB 8t				
	10 - HIGH ALTITUDE HANDLING (DEMO) - STALL RECOVERY AT HIGH ALTITUDE				
0:55	11 - EMERGENCY DESCENT	V	V	V	
	12 - AT FL 100 - RESTORE	V	V	V	
	13 - NDB RWY 33R USING FINAL APP	V	V	V	V
1:25	14 - LANDING				
	INIT TAKE OFF - LFZZ 33R				
	15 - TAKE OFF		V	V	
	16 - CLIMB 4500 ft	V	V	V	
	17 - TCAS EVENT	V	V	V	
	18 - FCU 1 + 2 FAULT				V
	19 - ILS RWY 33R - RAW DATA				V
1:50	20 - LANDING				

FFS 4 - TRAINEE 1

WEATHER		
LFZZ 36012KT 5000 OVC008 12/10 Q1010		
FLIGHT DATA		
FLT NBR [Airline ID] 204		
FROM	TO	ALTN
LFZZ	LFZZ	LFL
CO RTE	ALTN / CO RTE	
AIBAIB1	AIBLYS	
CRZ FL	CRZ TEMP	
FL 070	-1°C	
CI	TROPO	
30	36090	
TRIP WIND	TRIP DIST	
-	92 Nm	
FUEL & LOAD		
ZFW	54 t 118 800 lb	ZFWCG 32.7 %
FOB	11 t 24 200 lb	GW 65 t 143 000 lb
NOTES		
RWY COND DRY FPLN : Refer Co-route AIR COND ON ANTI ICE OFF		

PERF PAGE	PERF PAGE
LFZZ 33R	
V1 <input type="text"/> <input type="text"/> TOGA	V1 <input type="text"/> <input type="text"/> TOGA
VR <input type="text"/> <input type="text"/> FLEX	VR <input type="text"/> <input type="text"/> FLEX
V2 <input type="text"/>	V2 <input type="text"/>
FLAPS <input type="text"/>	FLAPS <input type="text"/>
PERF PAGE	PERF PAGE
V1 <input type="text"/> <input type="text"/> TOGA	V1 <input type="text"/> <input type="text"/> TOGA
VR <input type="text"/> <input type="text"/> FLEX	VR <input type="text"/> <input type="text"/> FLEX
V2 <input type="text"/>	V2 <input type="text"/>
FLAPS <input type="text"/>	FLAPS <input type="text"/>

Time	EVENTS	AP	FD	ATHR	TRK-FFA
	INIT HOLDING POINT - LFZZ 33R				
2:00	① 21 - TAKE OFF		V	V	
	22 - CLIMB NAV IR 3 FAULT	V	V	V	
	① 23 - CRUISE FL 070 - TCAS EVENT	V	V	V	
	24 - NAV IR 2 DISAGREE				V
	① 25 - ALTERNATE LAW				V
	26 - DESCENT				V
	① 27 - STALL RECOVERY AT LOW ALTITUDE				V
	28 - ILS RWY 33R - DIRECT LAW - RAW DATA				V
2:40	29 - LANDING				
	INIT FL 350 - FOB 8t - WIND 240/12 - OVC 1000 ft - VISI 8 km				
	① 30 - HIGH ALTITUDE HANDLING (DEMO) - STALL RECOVERY AT HIGH ALTITUDE				
2:50	① 31 - AIR COND SMOKE	V	V	V	
	32 - SMOKE / FUMES REMOVAL	V	V	V	
	33 - AT FL 100 - RESTORE	V	V	V	
	34 - LOC (G/S OUT) RWY 33R - CIRCLING RWY 15L	V	V	V	V
	35 - CIRCLING				V
3:30	36 - LANDING RWY 15L				
	INIT FL 350				
	① 37 - EMERGENCY DESCENT	V	V	V	
	38 - AT FL 100 - RESTORE	V	V	V	
	39 - NDB RWY 33R USING FINAL APP (if time permit)	V	V	V	V
	40 - GO AROUND - FREEZE				

FFS 4 SESSION PREPARATION

01 - SESSION OBJECTIVE

- Demonstration of F/CTL reconfiguration laws.
- SMOKE procedure.
- Practice approach and landing in alternate law.
- Demonstration of aircraft handling at high altitude (normal and alternate law).
- Practice stall recovery in different situations
- Practice EMERGENCY DESCENT.

02 - TRAINING TOPICS

A. REVIEW

- ECAM management
- Windshear
- Circling

B. EXERCISES / REFERENCES

EVENTS	FCOM	QRH	FCTM
• F/CTL RECONFIGURATION LAWS	DSC-27-20-20 PRO-ABN-27		OP.020
• DUAL ADR FAULT	PRO-ABN-34		AO.034
• IR DISCREPANCY	PRO-ABN-34		AO.034
• STALL RECOVERY	PRO-ABN-27	ABN	
• FCU FAULT	PRO-ABN-22 PRO-SUP-24		
• EMERGENCY DESCENT	PRO-ABN-80	ABN-80.05	AO.090
• SMOKE PROCEDURE	PRO-ABN-26	ABN-26	AO.026

C. SUPPORT

- FCOM / QRH - FCTM
- PDP:
 - ECAM management
 - Reconfiguration law
 - Stall recovery
 - Emergency descent
 - Total loss of FCU
 - Smoke
 - Circling
- **Training Tool #1: Training to prevent upset. Cd DVD4**

03- COMPETENCIES CRITERIA

The competencies criteria are: All criteria

 AIRBUS <small>Commercial Aircraft</small> A320 FLIGHT CREW TRAINING PROGRAM	STANDARD COURSE HANDLING PHASE	E F2S 02.04 FFS 4 Page 4
		Issue 11 JAN 2014

INSTRUCTOR ONLY

INSTRUCTOR ONLY

FFS 4 SESSION GUIDE

- ↑ **INIT HOLDING POINT:** Engines running, appropriate F/PLN inserted, ready for Take off.
- ↑ **2** Insert ADR 1 Fault at 5000 ft AGL.
- ↑ **5** Both crew members will carry out the following exercises in the vicinity of ROA VOR. (ADR 3 switching knob, to CPT then F/O accordingly).
 Demonstrate Alternate law.

 - Roll direct.
 - Yaw damping function is available.
 - No bank angle protection, No pitch limit protection.
 - High speed stability: nose up demand which can be overridden by the pilot.
 - Low speed stability: nose down demand which can be overridden by the pilot.
 - Landing gear down: Demonstrate direct law.
 - Pitch direct: USE MAN PITCH TRIM.
 - Yaw: Mechanical use of rudders.

Both crew members carry out stall recovery: in clean and in landing configuration

If you exceed certain limitations during this exercise, it could be possible to revert in Abnormal Attitude Law and to stay in it when you extend the landing gear. After a reset of the ELAC, you will recover a normal situation.
- ↑ **7** Insert a top of cloud at 2 500 ft, in order to be VMC at 3 700 ft.
 When the a/c is configured with FLAPS 2, L/G UP at F speed, ATC requests: *"When reaching 3 700 ft, perform a 360 for regulation"*.
 Maintain current configuration.
 Once turning, request the trainee to set the thrust levers to IDLE. Maintain altitude.
 Wait for buffet and/or stall warning and apply the stall recovery procedure.
 Then after, provide radar vectoring for ILS approach.
- ↑ **10** Objective: handle the aircraft at high altitude in normal and alternate law (introduction to unreliable airspeed situations). The goal is to focus on pitch/N1.
 This exercise is done IMC with light turbulences.
 Before releasing the simulator, determine with trainees, using QRH OPS.01 "SEVERE TURBULENCE", the turbulence speed and thrust setting (N1).
 Then, the trainee flies manually these parameters (AP, FD, A/THR, BIRD: OFF).
 When stable, observe pitch and N1. Compare them with those given in QRH 2.22 tables (UNRELIABLE SPEED INDIC/ADR CHECK PROC - Above FL250).
 Then, ask the trainee to increase pitch slightly. Observe that airspeed remains well within the limits between VLS and MMO/VMC.
 Return to FL350, with the previous flight parameters.
 When stable, insert failure: E/CTL ALTN LAW (if not avail: NAV IR 1 + 3 FAULT).
 Ask the trainee to perform a turn, increasing regularly the bank angle until buffet is detected and stall warning is triggered (exposure to buffet is the main objective). Then, apply the stall recovery procedure and return to the previous flight parameters.
 When stable, restore to Normal law, and engage auto flight system.
 Light turbulence may be used for this demonstration. The goal is to focus on pitch and N1
- ↑ **11** Activate CARGO DOOR switch fault. Perform ECAM actions. Meanwhile, activate EXCESSIVE CAB ALT: EMERGENCY DESCENT (structural damage).
- ↑ **17** TCAS RA

 A320 <small>TRAINING AND FLIGHT OPERATIONS SUPPORT AND SERVICES</small>	STANDARD COURSE HANDLING PHASE	E F2S	02.04
		FFS 4	Page 5
		Issue 11	JAN 2014
FLIGHT CREW TRAINING PROGRAM			

- ↑ 18 Insert FCU 1 + 2 Fault.
- ↑ 21 Arm Smoke Generator
- ↑ 23 TCAS RA
- ↑ 25 If non standard crew, refer to item 5.
- ↑ 27 Refer to item 7.
- ↑ 30 Objective: handle the aircraft at high altitude in normal and alternate law (introduction to unreliable airspeed situations). The goal is to focus on pitch/N1.
This exercise is done IMC with light turbulences.
Before releasing the simulator, determine with trainees, using QRH OPS.01 "SEVERE TURBULENCE", the turbulence speed and thrust setting (N1).
Then, the trainee flies manually these parameters (AP, FD, A/THR, BIRD: OFF).
When stable, observe pitch and N1. Compare them with those given in QRH 2.22 tables (UNRELIABLE SPEED INDIC/ADR CHECK PROC - Above FL250).
Then, ask the trainee to increase pitch slightly. Observe that airspeed remains well within the limits between VLS and MMO/VMO.
Return to FL350, with the previous flight parameters.
When stable, insert failure: F/CTL ALTN LAW (if not avail: NAV IR 2 + 3 FAULT).
Ask the trainee to perform a turn, increasing regularly the bank angle until buffet is detected and stall warning is triggered (exposure to buffet is the main objective). Then, apply the stall recovery procedure and return to the previous flight parameters.
When stable, restore to Normal law, and engage auto flight system.
Light turbulence may be used for this demonstration. The goal is to focus on pitch and N1
- ↑ 31 - Use smoke generator or indicate that smoke is coming to the cockpit from the outlets (AIR CONDITIONING SMOKE suspected)
- Crew will apply SMOKE / FUMES / AVIONICS SMOKE PROC.
- Smoke building up until PACK 2 is set OFF.
- Indicate smoke emission decreases but dense fumes still persist.
- Complete SMOKE / FUMES REMOVAL PROC.
- Stop exercise when RAM AIR p/b is set ON.
- Monitor the cabin rate with RAM AIR opened.
- ↑ 37 Insert EXCESS CAB ALT: EMERGENCY DESCENT (no structural damage).

INSTRUCTOR ONLY

6.7 Summary of “PK-AXC Defect 1 Year” Report

The last one year maintenance recorded related to the RTLU problems are shown in the table below;

No	DATE	PILOT REPORT OR PFR	RECTIFICATION	TSM/AMM REFERENCE
1	10 Jan 2014	AUTO FLIGHT: RUDER TRV LIMITER 1 (ECAM)	BITE test of AFS result satisfactory check ECAM messages disappear as per AMM 22-96-00-710-001	AMM 22-96-00-710-001
2	18 FEB 2014	AUTO FLT RUDDER TRV LIM 2	As per TSM 22-61-00-810-804-A do open CB AUTO FLT/FAC2/28VDC FIN 5CC2 M19 and do operational test AFS via MCDU as per AMM 22-96-00-710-001-A defect result satisfactory.	TSM 22-61-00-810-804-A AMM 22-96-00-710-001-A
3	16 MAY 2014	RUD TRV LIM 1 FAULT	Do AFS test AMM 22-96-00-710-001-A, SATIS	AMM 22-96-00-710-001-A
4	29 JUN 2014	AUTOFLT : RUDDER TRV LIM 1 appeared on app.	AFS test as per AMM 22-96-00-710-001 carried out result satisfactory, message disappear	AMM 22-96-00-710-001
5	28 JUL 2014	AUTO FLT RUD TRV LIM 1 appear on ECAM	Do AFS test AS PER AMM 22-96-710-001A result pass ECAM message disappear	AMM 22-96-710-001A
6	08 AUG 2014	During cruise on first sector, AUTO FLIGHT RUDER TRIM LIMITER 1 FAULT appear on ECAM	TSM 22-61-00--810-802 do reset CB 5CC1 and after test as per AMM 22-96-00-710-001 result satisfactory	TSM 22-61-00--810-802 AMM 22-96-00-710-001
7	26 SEP 2014	AUTO FLT RUD TRV LIM 2	1 and 2 CB recycled. AFS test carried pass. Test carried out pass, hydraulic pressurise nil fault AMM 22-96-00	AMM 22-96-00
8	25 OCT 2014	AUTO FLT RUD TRV LIM SYS , appeared after shutting down engine 1 and APU	No related message was capture on PFR. Perform AFS test, resulting: 22-66-34 FAC1/RTL engage change over, FAC1 puch	TSM 22-66-00-810-817A

No	DATE	PILOT REPORT OR PFR	RECTIFICATION	TSM/AMM REFERENCE
		establish (single engine taxi)	button, CB B03&B04 recycled, message clear, AFS test passed REFF TSM 22-66-00-810-817A	
9	27 OCT 2014	- AUTO FLT RUD TRV LIM SYS APP170 1903821 AXC Closed 13.Nov.2014 13.Nov.2014 22 P AXI122 - AUTO FLT RUD TRV LIM 1	- Refer to TSM 22-61-00-810-803-A, do operational test of the AFS as per AMM 22-96-00-710-001. Result passed on ECAM - BITE test of auto flight system as per AMM 22-66-34. message clear	TSM 22-61-00-810-803-A AMM 22-96-00-710-001 AMM 22-66-34
10	10 NOV 2014	AUTO FLIGHT RUD TRV LIM 1	Do fault confirmation refer to TSM task 22-61-00-810-2013A with do the operational test of the AFS AS PER AMM 22-96-00-710-001 result pass	TSM 22-61-00-810-2013A AMM 22-96-00-710-001
11	13 NOV 2014	AUTO FLT RUD TRV LIM 1	Refer to TSM 22-61-00-810-803-A, do operational test of the AFS as per AMM 22-96-00-710-001. result passed	TSM 22-61-00-810-803-A AMM 22-96-00-710-001
12	20 NOV 2014	AUTO FLT RUD TRV LIM SYS	Fault carried out the reset of CB nil further fault EFCS ground scanning carried out as per AMM 27-96-00. Found satisfactory, crew to further monitor	AMM 27-96-00
13	22 NOV 2014	AUTO FLT RUDDER TRV LIMIT 1	Operational test of AFS as per AMM 22-96-00-710-001A result satisfactory	AMM 22-96-00-710-001A
14	24 NOV 2014	AUTO FLIGHT RUDDER TRV LIMITER 2	Do BITE test of AUTO FLIGHT system result satisfactory. Message disappear. IAW AMM 22-96-00-71-001-A	AMM 22-96-00-71-001-A
15	01 DEC	AUTO FLT RUD	Operational test of AFS as	AMM 22-9600-710-

No	DATE	PILOT REPORT OR PFR	RECTIFICATION	TSM/AMM REFERENCE
	2014	TRV LIM 1	per AMM 22-9600-710-001A result satisfactory and message disappeared	001A
16	12 DEC 2014	AUTO FLIGHT RUD TRV LIM 1	Do fault confirmation with operational test of AFS as per AMM 22-96-00-710-001A carried result satisfactory. Message disappear	AMM 22-96-00-710-001A
17	14 DEC 2014	AUTO FLT RUDDER TRAVEL LIMITER 1	Do fault confirmation with BITE test of AFS as per AMM 22-96-00-710-001A carried out result pass and message disappear	AMM 22-96-00-710-001A
18	19 DEC 2014	ECAM: AUTOFLIGHT RUD TRV LIMSYS THEN INOP YS: RUD TRV LIM 2	Check on PFR no ECAM fault related defect do operational test AFS as per AMM22-96-00-710-001-A result satisfactory	AMM22-96-00-710-001-A
19	21 DEC 2014	AUTO FLIGHT RUDDER TRV LIM SYS (DURING APP)	AFS BITE performed carried out satisfactory AMM 22-96-00-710-001	AMM 22-96-00-710-001
20	24 DEC 2014	AUTO FLT RUD TRV LIM SYS	FAC 1 AND FAC 2 CB reset carried out satisfactory. AFS BITE test carried out satisfactory REF 22-96-00	AMM 22-96-00
21	25 DEC 2014	AUTO FLT RUD TRV LIM SYS	Reset both FAC 1&2, result satisfactory. Work REF TSM 24-00-00 PB201	TSM 24-00-00 PB201
22	25 DEC 2014	AUTO FLT RUD TRV LIM SYS	TSM 22-66-00-810-818A applied. Replaced FAC#2, result satisfactory. Work refer AMM 22-66-34 PB401 FAC position 2 P/N B397BAM0620 replaced S/N OFF: Q00140012268 S/N ON: Q00140021622	TSM 22-66-00-810-818A AMM 22-66-34 PB401
23	26 DEC 2014	FAC #2 ROBBED BACK TO ORIGINAL PK-AXV	Installation the FAC #2 carried out as per AMM 22-66-34 PB401. Result satisfactory.	AMM 22-66-34 PB401

No	DATE	PILOT REPORT OR PFR	RECTIFICATION	TSM/AMM REFERENCE
24	27 DEC 2014	During taxi in ON WARR AUTO FLT RUD TRV LIM SYS ILL	Do check on PFR no relate message on failure message. Continue reset of FAC 1 and FAC 2 as per AMM 24-00-00 PB 401 result satisfied. Please continue monitor further	AMM 24-00-00 PB 401

6.8 PFR Summary

Table of PFR Summary 27 November 2014 – 27 December 2014.

No	Date	City pair	Flight Phase	Msg. Time (GMT)	Warning Message	Failure Message
1	01-12-2014	WIII – WARR	6	12.53	AUTO FLT RUD TRV LIM 1	AFS: FAC1/RTL ACTR
2	12-12-2014	WIII – WARR	2	07.55	AUTO FLT RUD TRV LIM 1	AFS: FAC2/RTL ACTR
	12-12-2014	WIII – WARR	2	07.55	AUTO FLT RUD TRV LIM SYS	AFS: FAC1/RTL ACTR
	12-12-2014	WIII – WARR	2	07.56	AUTO FLT RUD TRV LIM 2	AFS: FAC1/P-B SW
	12-12-2014	WIII – WARR	2	07.56	AUTO FLT RUD TRV LIM 1	AFS: FAC2/P-B SW
3	21-12-2014	WARR – WSSS	6	23.05	AUTO FLT RUD TRV LIM 1	AFS: FAC1/RTL ACTR
	21-12-2014	WARR – WSSS	6	23.06	AUTO FLT RUD TRV LIM SYS	AFS: FAC2/RTL ACTR
	21-12-2014	WARR – WSSS	6	23.06	AUTO FLT RUD TRV LIM 2	AFS: FAC1/P-B SW
	21-12-2014	WARR – WSSS	6	23.13	AUTO FLT RUD TRV LIM 1	AFS: FAC2/P-B SW

No	Date	City pair	Flight Phase	Msg. Time (GMT)	Warning Message	Failure Message
4	21-12-2014	WIII – WARR	6	05.12	AUTO FLT RUD TRV LIM 1	AFS: FAC1/RTL ACTR
	21-12-2014	WIII – WARR	6	05.12	AUTO FLT RUD TRV LIM SYS	AFS: FAC2/RTL ACTR
5	22-12-2014	WIII – WARR	2	12.12	AUTO FLT RUD TRV LIM 1	AFS: FAC1/RTL ACTR
6	22-12-2014	WARR – WIII	6	00.00	AUTO FLT RUD TRV LIM 1	AFS: FAC1/RTL ACTR
7	23-12-2014	WIII – WARR	2	00.41	AUTO FLT RUD TRV LIM 1	AFS: FAC1/RTL ACTR
8	23-12-2014	WARR – WADD	6	13.43	AUTO FLT RUD TRV LIM 1	AFS: FAC1/RTL ACTR
9	23-12-2014	WMKP – WARR	6	09.27	AUTO FLT RUD TRV LIM 1	AFS: FAC1/RTL ACTR
	23-12-2014	WMKP – WARR	6	09.27	AUTO FLT RUD TRV LIM SYS	AFS: FAC2/RTL ACTR
	23-12-2014	WMKP – WARR	6	09.29	AUTO FLT RUD TRV LIM 2	AFS: FAC1/P-B SW
	23-12-2014	WMKP – WARR	6	09.54	AUTO FLT RUD TRV LIM 1	AFS: FAC2/P-B SW
10	24-12-2014	WMKK – WARR	5	10.10	AUTO FLT RUD TRV LIM 1	AFS: FAC1/RTL ACTR

No	Date	City pair	Flight Phase	Msg. Time (GMT)	Warning Message	Failure Message
11	25-12-2014	WARR – WMKK	2	11.53	AUTO FLT RUD TRV LIM SYS	PFR Summary (page 145) in the table, failure messages of the December 25 th flight are missing, especially messages that report “AFS: FAC1/RTL ACTR 4CC” or “FAC2/RTL ACTR 4CC” failures
	25-12-2014	WARR – WMKK	2	11.54	AUTO FLT RUD TRV LIM SYS	
	25-12-2014	WARR – WMKK	2	11.55	AUTO FLT RUD TRV LIM 2	
	25-12-2014	WARR – WMKK	2	11.55	AUTO FLT RUD TRV LIM SYS	
	25-12-2014	WARR – WMKK	2	11.55	AUTO FLT RUD TRV LIM SYS	
	25-12-2014	WARR – WMKK	2	11.55	AUTO FLT RUD TRV LIM 1	
	25-12-2014	WARR – WMKK	2	11.55	AUTO FLT RUD TRV LIM SYS	
	25-12-2014	WARR – WMKK	2	11.56	AUTO FLT RUD TRV LIM 2	
	25-12-2014	WARR – WMKK	2	11.56	AUTO FLT RUD TRV LIM 1	
	25-12-2014	WARR – WMKK	2	11.56	AUTO FLT RUD TRV LIM SYS	

6.9 Troubleshooting Manual (TSM) Task 22-61-00-810-803-A

**** ON A/C ALL**

TASK 22-61-00-810-803-A

Loss of the Rudder Travel Limiting Function on the FAC 1

1. Possible Causes

- Wiring for 28VDC signal (pin A2) and GND signal (pin X2) at the relay (13CC1)
- Wiring of the RTL ACT VALID signal from the FAC1 to the RTLU and associated GND signal at the RTLU
- RTL electronic module
- LIMITATION UNIT-RUDDER TRAVEL ([4CC](#))
- Wiring of the RTL ACT PWR ON signal from the FAC1 to the relay 13CC1
- RELAY-RTL SYS1 ([13CC1](#))
- Wiring of the 28VDC and GND at the RTLU (PWR SPLY)
- FAC-1 ([1CC1](#))
- SW-LOW OIL PRESS ([4000EN](#))
- Wiring from the FAC 1 (1CC1) to the rudder travel limitation-unit (4CC)
- SENSOR-TAT, 1 ([11FP1](#))
- Wiring of the RTL V1 and RTL V2 discretes from the FAC 1 (1CC1) to the rudder travel limitation-unit (4CC)

2. Job Set-up Information



A.

Referenced Information

REFERENCE	DESIGNATION
AMM 22-61-00-710-001	Operational Test of the Rudder Travel Limiting Function
AMM 22-66-34-000-002	Removal of the FAC
AMM 22-66-34-400-002	Installation of the FAC
Ref. ASM 22-67-01	
Ref. ASM 22-68-02	
AMM 22-96-00-710-001	Operational Test of the AFS
AMM 27-23-51-000-001	Removal of the Rudder Travel Limitation Unit
AMM 27-23-51-000-002	Removal of the Electronic Module of the Rudder Travel Limitation Unit
AMM 27-23-51-400-001	Installation of the Rudder Travel-Limitation Unit
AMM 27-23-51-400-002	Installation of the Electronic Module of the Rudder Travel Limitation Unit
AMM 34-11-18-000-001	Removal of the TAT Sensor
AMM 34-11-18-400-001	Installation of the TAT Sensor
AMM 79-34-15-000-041	Removal of the Low Oil Pressure Switch
AMM 79-34-15-400-041	Installation of the Low Oil Pressure Switch

3. Fault Confirmation

Subtask 22-61-00-865-050-A

A. Make sure that this(these) circuit breaker(s) is(are) closed:

PANEL	DESIGNATION	FIN	LOCATION
49VU	AUTO FLT/FAC1/28VDC	5CC1	B04

Subtask 22-61-00-710-054-A

B. Test

(1) Open the circuit breaker 5CC1.

(2) After a minimum of 10 seconds, close the circuit breaker 5CC1.

(3) After 2 minutes, do the operational test of the AFS [AMM 22-96-00-710-001](#) and read the result for the FAC 1.

4. Fault Isolation

Subtask 22-61-00-810-052-D

A. If the test gives the maintenance message AFS : FAC1/RTL ACTR 4CC:

- Replace the RTL electronic module on the rudder travel limitation-unit [AMM 27-23-51-000-002](#) and [AMM 27-23-51-400-002](#).

(1) If the fault continues:

- Replace the rudder travel limitation-unit 4CC [AMM 27-23-51-000-001](#) and [AMM 27-23-51-400-001](#).

(2) If the fault continues:

- Open the circuit breaker 5CC1

- Remove the relay 13CC1

- Close the circuit breaker 5CC1

- Do a check of the correct Wiring for 28VDC signal (pin A2) and GND signal (pin X2) at the relay (13CC1) , if no repair it [Ref. ASM 22-68-02](#)

- Open the circuit breaker 5CC1

- Remove the FAC-1 (1CC1) [AMM 22-66-34-000-002](#)

- Install the above removed relay (13CC1).

(3) Do a check of the impedance of the RTL ACT VALID signal between the pin AB/11A and the pin AC/3 (GND signal) of the FAC-1 rack connector, [Ref. ASM 22-68-02](#) and [Ref. ASM 22-67-01](#).

NOTE:The impedance must be more than 70 Ohms and not open circuit.

(a) If the impedance is not correct (< 70 Ohms or open circuit):

- Do a check of the Wiring of the RTL ACT VALID signal from the FAC1 to the RTLU and associated GND signal at the RTLU [Ref. ASM 22-68-02](#).

1 If the wiring is correct:

- Install the above removed FAC-1 [AMM 22-66-34-400-002](#)

- Replace the RTL electronic module on the rudder travel limitation-unit (4CC) [AMM 27-23-51-000-002](#) and [AMM 27-23-51-400-002](#).

a If the fault continues:

- Replace the LIMITATION UNIT-RUDDER TRAVEL (4CC) [AMM 27-23-51-000-001](#) and [AMM 27-23-51-400-001](#).

(b) If the impedance is correct (no short circuit and no open circuit):

- Do a check of the impedance of the RTL ACT PWR ON signal between the pin AE/11A and the pin AC/3 of the FAC-1 rack connector, [Ref. ASM 22-68-02](#) and [Ref. ASM 22-67-01](#).

NOTE:The impedance must be more than 70 Ohms and not open circuit.

1 If the impedance is not correct (< 70 Ohms or open circuit):

- Remove the relay 13CC1 (open the circuit breaker 5CC1 before and close it after)

- Do a check of the Wiring of the RTL ACT PWR ON signal from the FAC1 to the relay 13CC1 [Ref. ASM 22-68-02](#).

a If the wiring is correct:

- Replace the RELAY-RTL SYS1 (13CC1)

- Install the above removed FAC-1 [AMM 22-66-34-400-002](#).

2 If the impedance is correct (RTL ACT VALID and RTL ACT PWR ON signals):

- Do a check of the Wiring of the 28VDC and GND at the RTLU (PWR SPLY) [Ref. ASM 22-68-02](#).

a If incorrect, repair the wiring.

b If correct, replace the RELAY-RTL SYS1 ([13CC1](#)).

If the fault continues:

- Replace the FAC-1 ([1CC1](#)) [AMM 22-66-34-400-002](#).

(4) If the fault continues:

- Replace the ENG 1 and ENG 2 SW-LOW OIL PRESS ([4000EN](#)) [AMM 79-34-15-000-041](#) and [AMM 79-34-15-400-041](#).

(5) If the fault continues:

- Do a check and repair the remaining Wiring from the FAC 1 (1CC1) to the rudder travel limitation-unit (4CC) [Ref. ASM 22-68-02](#).

Subtask 22-61-00-710-055-A

B. If the test does not give the maintenance message AFS: FAC 1/RTL ACTR 4CC:

(1) If the test gives the maintenance message TAT SENSOR (11FP1)/ADIRU1 (1FP1):

- Replace the SENSOR-TAT, 1 ([11FP1](#)) [AMM 34-11-18-000-001](#) and [AMM 34-11-18-400-001](#).

(2) If the fault continues or if the test does not give the maintenance message TAT SENSOR

- Do a check if any fault message related to FAC or RTL function is recorded in the PFR.

(a) If no fault message is recorded:

- No trouble shooting procedure is necessary.

(b) If the fault message AFS: FAC1/RTL ACT 4CC is recorded:

- Replace the RTL electronic module on the rudder travel limitation-unit [AMM 27-23-51-000-002](#) and [AMM 27-23-51-400-002](#).

(c) If the fault continues:

- Replace the rudder travel limitation-unit (4CC) [AMM 27-23-51-000-001](#) and [AMM 27-23-51-400-001](#).

Subtask 22-61-00-810-053-A

C. If the fault continues:

(1) Do the operational test of the rudder travel limiting function [AMM 22-61-00-710-001](#).

(a) If the rudder does not move or stops before the rudder travel limit:

- Replace the FAC-1 (1CC1) [AMM 22-66-34-000-002](#) and [AMM 22-66-34-400-002](#).

(b) If the fault continues:

- Replace the RTL electronic module of the rudder travel limitation-unit [AMM 27-23-51-000-002](#) and [AMM 27-23-51-400-002](#).

(c) If the fault continues:

- Replace the rudder travel limitation-unit (4CC) [AMM 27-23-51-000-001](#) and [AMM 27-23-51-400-001](#).

(d) If the fault continues:

[Text continues : see text below](#) 

6.10 Reliability Report November 2014



IAA

AIRASIA A320-200 FLEET RELIABILITY REPORT
NOVEMBER 2014
Indonesia AirAsia

Page
11 of 30

4. PIREPS

4.1 REPETITIVE DEFECTS

The following ATAs for AirAsia's A320 fleet were investigated where there were repetitive defects on same aircraft.

4.1.1 DEFECT REPORTED : AUTO FLT RUD TRV LIM 1 – ATA 22

- 4 Pireps was reported on PK-AXC

Common Part : Auto Flight System

Action: Carried out troubleshooting of AFS as per TSM 22-61-00-810-803-A and perform operational test as per AMM 22-96-00-710-001. No further action required.

4.1.2 DEFECT REPORTED : F/CTL ELAC 1 FAULT – ATA 27

- 4 Pireps was reported on PK-AXC

Common Part : ELAC

Action: Bite Test of EFCS carried out as per AMM 27-96-00-740-001 and TSM 27-93-00-810-901A. ELAC replaced for trouble shoot.

4.1.3 DEFECT REPORTED : L/S SYS DISAGREE – ATA 32

- 4 Pireps were reported on PK-AXC

Common Part : Proximity Sensor

Action : Performed troubleshooting as per PFR message L/R Door Closed Proximity Sensor 29GA TGT according to TSM 32-31-810-837-A and resistance check of proximity sensor as per AMM 32-31-73-820-009. Result of the resistance check of the proximity sensor still within limit.

4.1.4 DEFECT REPORTED : BRAKES ALTN R RELEASED – ATA 32

- 4 Pireps were reported on PK-AXU

Common Part : BSCU

Action : Performed troubleshooting on BSCU according to TSM 32-43-00-810-825-A and reset of BSCU as per AMM 32-46-00-740-001A. Fault cleared.

4.1.5 DEFECT REPORTED : AIR ENGINE 1 BLEED FAULT – ATA 36

- 4 Pireps were reported on PK-AXJ

Common Part : BMC

Action : Performed Operational Test on the Bleed Monitoring Computer as per TSM 36-11-00-740-001. No further action required.

CONTRACTS AND WARRANTY DEPARTMENT
RELIABILITY SECTION

6.11 Startle Reflex

The human startle reflex was famously investigated by Landis and Hunt (1939) who filmed the reactions of people to an unexpected pistol shot occurring just behind them. It is now well established that there is a reflex-like event (startle reflex) that blinks the eyes and causes a whole body 'jerk' to occur (similar to that sometimes caused in sleep). This reflex has a relatively basic neural pathway from the sense organ. Many things can cause (or contribute to) a startle reflex, including sudden noises, unexpected tactile sensations, abrupt shocking perceptions, the sensation of falling or an abrupt visual stimulus.

There is little evidence that a startle reflex alone creates much of a sustained or lasting impact on cognitive functions (although there are some minor and short lived physiological changes such as raised heart rate). A skilled motor task will be momentarily disrupted by a startle reflex but return to normal within five to ten seconds. For more details see Thackray & Touchstone (1970).

For pilots, the main effects of the startle reflex are the interruption of the on going process and distraction of attention towards the stimulus. These happen almost immediately, and can be quickly dealt with if the cause is found to be non-threatening; for more detail see Graham (1979), Herbert, Kissler, Junghöfer, Peyk & Rockstroh (2006) or Schupp, Cuthbert, Bradley, Birbaumer & Lang (1997). A

further possibility is that any 'primed' motor action may be triggered. For more detail see Valls-Sole, Kumru, Kofler (2008).

Reaction to Fear

A perception of fear can cause a startle reflex to be potentiated (more pronounced) should it occur and attention to become more focused. In a state of fear, very little is required to trigger a full 'fight or flight' response (a startle will probably be sufficient at this point).

Fight or Flight

When we perceive a serious and imminent threat (whether we are already in a high state of fear or not) the hypothalamus initiates a cascade of events (nervous and hormonal) such as increased heart rate and breathing, secretion of adrenaline, and increased sweating. This is called the alarm reaction and is part of 'fight or flight' (stress). These changes immediately prepare the body for action to maximize the chances of survival in the anticipated imminent encounter. No startle is required to activate the fight or flight response, although a startling stimulus may be part of, or coincident with, the same threat

Importantly the alarm element of the fight or flight response also appears to have an immediate and sustained impact on our cognition. All mental capacity becomes focused on the threat and/or the escape from it. As long as the required response to the threat is to engage in a single basic task (i.e. a single learned skill or set of easy steps) then this focusing of attention resource can be beneficial. The senses can appear heightened to the threat and the level of attention is very high but very focused.

Some experimental evidence has suggested a decrease in memory performance of recently learned information (using memory tests) during fight or flight. But there is little evidence that long-term memory or skills are negatively affected, except in terms of manipulation issues (coordinating the skill, e.g. with tremor). So it is probable that old established learning and innate knowledge trumps new learning during fight or flight. This may be part of the explanation for an effect often called 'primacy' whereby individuals report that in difficult situations they reverted to early (or previous) learning, even when it was inappropriate to do so (for example reverting to the handling characteristics of a previous aircraft type).

A vicious circle

Hypothetically and anecdotally, during fight or flight pilots can get mentally 'stuck' within a situation (unable to interpret or resolve a situation, and unable to move on, even if that situation would present no problems under normal circumstances). This usually happens when the situation is ambiguous or requires problem solving.

In a fight or flight state, time is key to survival. In modern humans, the fight or flight response is accompanied by an urge to be engaged in the active solution. But to do this the person must know (or be told) what response to take. In ambiguous cases this might not be obvious, and might require problem solving or complex thinking to assess the situation or response required. But in fight or flight, the brain wants to quickly establish a very basic mental model then drop any assessment process in

order to concentrate all attention to the response. But if resources are not given to assessment and problem solving then the person cannot decide the best response. This situation would be best described as a vicious circle. As part of this, during the fight or flight response the brain favours sources of information that require the minimum of processing. This means simple 'real-world' cues or conditioned cues and responses.

All this worked well in nature, over millennia. However it is a problematic strategy when dealing with new technology (within which humans have not evolved). Human processes are not perfectly adapted to perceive the cues and information from modern interfaces. Such information requires more mental processing than does 'real world' information, particularly in new situations.

Taking all the above into account, it can be helpful to hypothesise a vicious circle occurring during ambiguous situations on modern flight decks, as follows: The brain requires a basic and quick understanding of the problem in order to act at once. But because flight deck information is often abstract and unnatural, the pilot requires more time to work out the problem than they would if the cues were natural real-world ones; time that they are unconsciously not willing to allow. Unless this conflict is resolved, the pilot becomes mentally 'stuck' (the start of the vicious circle).

Let us take a simple example: an unusual attitude. While easy enough normally, when experiencing extreme fight or flight, a pilot may glance at the attitude indicator but be unable to make sense of it (particularly an unusual and unfamiliar attitude) because the brain does not want to dwell on assessment, but wants to be engaged in the task resolution. The pilot (consciously) does not know the attitude and needs a little more resource and time before acting or responding. The pilot is stuck. Anecdotally, this feels like a mental blank. There is no easy solution:

1. If the pilot yields to the unconscious urge and breaks the vicious circle by making a spurious or guessed response then this could solve the situation by lucky chance (an action was effective) but also risks disaster (such as a fatally wrong control input). In any case, if the action does not solve the situation (or leads to a further threatening situation) the fight or flight continues, and nothing is resolved.
2. Alternatively, if the pilot continues trying to process the information then they may not receive the resource to process it while in that state, and so remain stuck.

6.12 Ebbinghaus Curve and Review

The first experimental research on retention was conducted between 1879 and 1885 by Hermann Ebbinghaus, a German psychologist. Realizing that memory is strongly affected by both meaning and association, Ebbinghaus decided to test his memory capabilities by using nonsense words of the same length. He discovered that whatever is 'learned' suffers a rapid initial decrease in memory followed by a slower decrease over time. That is, most forgetting occurs immediately after learning.

To summarize his research, he produced a graphic representation, which has become known as the Ebbinghaus Curve (Ebbinghaus, 1885). While this is a very old study, and loses some credibility based on the fact that Ebbinghaus used nonsense words

rather than real content, it is still important information and fascinating that the concept was known over a hundred years ago. Modern psychologists have replicated his six-year experiment many times and have discovered that their results are the same.

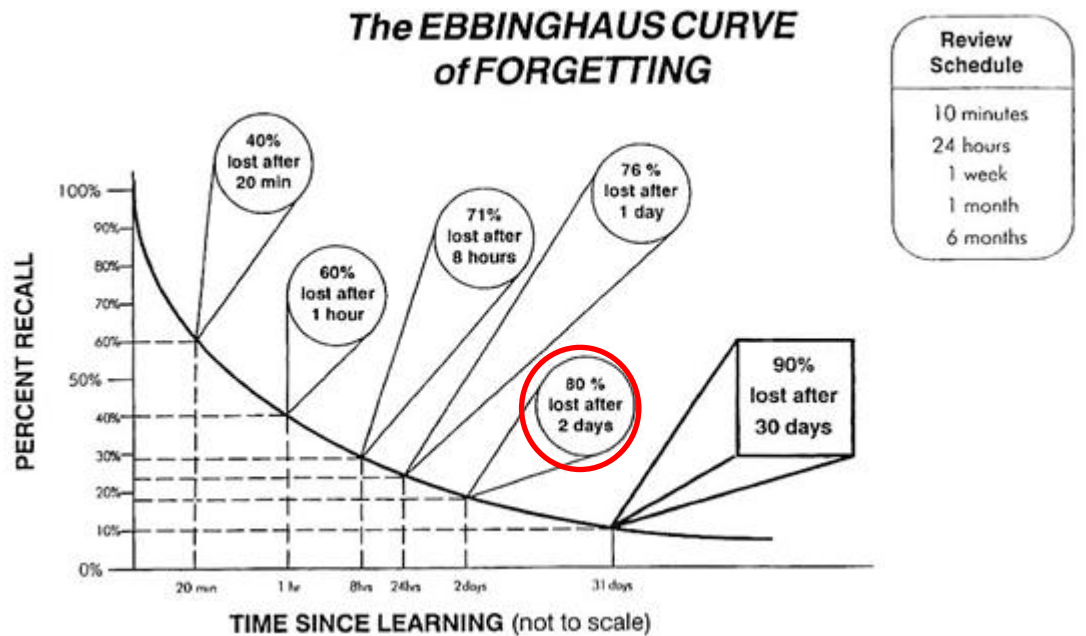

6.13 Accredited Representatives Comments

Comment Reference	Reference chapter, page, paragraph	Commented extract	Reason for proposed change	Proposed amendment	Remarks
1	General comment when "Airbus Industries » is mentioned.		"Airbus Industries" is the former name of "Airbus".	Replace "Airbus Industries" by "Airbus" everywhere in the report	Accepted
2	Page § ABBREVIATIONS AND DEFINITIONS x	FCDC: Flight Control Data Concentrators	singular	FCDC: Flight Control Data Concentrator	Accepted
3	Page § ABBREVIATIONS AND DEFINITIONS x	INCERFA: It is a situation in which there is uncertainty as to the safety of an aircraft and its occupants	Space to add	INCERFA: It is a situation in which there is uncertainty as to the safety of an aircraft and its occupants	Accepted
4	Page § ABBREVIATIONS AND DEFINITIONS xi	MHz : Mega Hertz is the unit of frequency in the International System of Units(SI) and is defined as one cycle per second	Precision	MHz : Mega Hertz is the unit of frequency in the International System of Units(SI) and is defined as one million cycles per second	Accepted
5	Page § ABBREVIATIONS AND DEFINITIONS xii	PFR: Post Flight Report is an automatic reporting system shows on the Centralized Fault Display System (CFDS)..	Space to add	PFR: Post Flight Report is an automatic reporting system shows on the Centralized Fault Display System (CFDS)...	Accepted
6	ABBREVIATIONS AND DEFINITIONS, page XIII	Technical Follow Up	The abbreviation of this definition is missing	TFU: Technical Follow Up	Accepted
7	ABBREVIATIONS AND DEFINITIONS, page XIII	YDF: Yaw Damper	The abbreviation YDF means Yaw Damper Fault	YDF: Yaw Damper Fault	Accepted
8	Synopsis, page 1, 2 nd paragraph	This pilot action resulted on the 5 th and 6 th master caution activations which correspond to ECAM message of AUTO FLT FAC FAULT. Following the 6 th master caution, the autopilot and auto-thrust disengaged and the flight control reverted to Alternate Law which means the aircraft lost several protections available in Normal Law. The aircraft entered an upset condition and the stall warning activated until the end of recording.	The ECAM messages corresponding to the FAC CBs being pulled are respectively AUTO FLT FAC 1 FAULT and AUTO FLT FAC 1+2 FAULT. A master caution does not disconnect the AP and A/THR and does not revert the flight control to Alternate law. A FAC fault triggers a master caution, and the fact that both FAC were OFF had for consequences the AP and A/THR disconnection and the reversion to Alternate law.	This pilot action resulted on the 5 th and 6 th master caution activations which correspond respectively to ECAM message of AUTO FLT FAC 1 FAULT and AUTO FLT FAC 1+2 FAULT. Following the two FAC fault 6 th master caution, the autopilot and auto-thrust disengaged and the flight control reverted to Alternate Law which means the aircraft lost several protections available in Normal Law. The aircraft entered an upset condition and the stall warning activated until the end of recording.	Accepted
9	Synopsis, page 1, 3 rd paragraph	The aircraft entered an upset condition and the stall warning activated until the end of recording.	Information regarding pilot actions is missing in this paragraph. The aircraft entered an upset condition following the 6 th master caution and the autopilot disengagement due to inadequate pilot actions.	Subsequent mishandling resulted in the aircraft entering an upset condition and the stall warning activated until the end of recording.	Proposal rejected
10	Synopsis, page 1, 5 th paragraph (last bullet) + each time "deep stall" is mentioned (pages 96, 97 and 106) replace "deep	Subsequent mishandling resulted in the aircraft departing the flight envelope and entering a deep stall that was beyond the capability of the flight crew to recover.	Per definition, "deep stall" means a stall condition so that the THS is no longer able to pitch-down the aircraft. Beyond the limit of the known flight domain (explored in flight tests) the behavior of the aircraft is unknown.	Subsequent mishandling resulted in the aircraft departing the flight envelope and entering a developed stall condition well beyond AOA stall.	Accepted

Comment Reference	Reference chapter, page, paragraph	Commented extract	Reason for proposed change	Proposed amendment	Remarks
	stall" by "developed stall condition well beyond AOA stall"				
11	History of Flight (1.1), page 3, 1 st paragraph	The ECAM message showed "AUTO FLT RUD TRV SYS" (Auto Flight Rudder Travel Limiter System).	The ECAM message displayed was AUTO FLT RUD TRV LIM SYS.	The ECAM message showed "AUTO FLT RUD TRV LIM SYS" (Auto Flight Rudder Travel Limiter System).	Accepted
12	History of Flight (1.1), page 3, 8 th paragraph	At 2315:36 UTC, the fourth failure on both Rudder Travel Limiter Units and triggered ECAM message "AUTO FLT RUD TRV LIM SYS", chime and master caution light.	Incomplete	At 2315:36 UTC, the fourth failure on both Rudder Travel Limiter Units and triggered ECAM message "AUTO FLT RUD TRV LIM SYS", chime and master caution light. 3 seconds later, a sound similar to a seat motion is heard.	Proposal rejected
13	History of Flight (1.1), page 3, 10 th paragraph	At 2316:27 UTC, the fifth Master Caution which was triggered by FAC 1 FAULT followed by FDR signature of erratic fluctuation of parameters of components controlled by FAC 1 such as RTLU 1, Windshear Detection 1 and Rudder Travel Limiter Actuator 1.	The fifth Master Caution occurred at 2316:29 UTC + new explanation.	At 2316:29 UTC, the fifth Master Caution which was triggered by FAC 1 FAULT followed by FDR signature of erratic fluctuation of parameters of components controlled by FAC 1 such as RTLU 1, Windshear Detection 1 and Rudder Travel Limiter Actuator 1. being de-energized concomitant with FDR signature of unavailability of parameters computed by FAC 1 such as RTLU 1, Windshear Detection 1 and Rudder Travel Limiter Actuator 1."	Proposal rejected
14	History of Flight (1.1), page 4, 1 st paragraph	At 2316:44 UTC, the sixth Master Caution triggered by AUTO FLT FAC 1 + 2 FAULT and followed by FDR signature of erratic fluctuation of parameters of components controlled by FAC 2 such as RTLU 2, Windshear Detection 2 and Rudder Travel Limiter Actuator 2.	The sixth Master Caution occurred at 2316:46 UTC + new explanation	At 2316:46 UTC, the sixth Master Caution triggered by AUTO FLT FAC 1+2 FAULT and followed by FDR signature of erratic fluctuation of parameters of components controlled by FAC 2 such as RTLU 2, Windshear Detection 2 and Rudder Travel Limiter Actuator 2. FAC2 being also de-energized concomitant with FDR signature of unavailability of parameters computed by FAC 2 such as RTLU 2, Windshear Detection 2 and Rudder Travel Limiter Actuator 2.	Proposal rejected
15	History of Flight (1.1), page 4, 2 nd paragraph	The aircraft roll angle reduced to 9° left and then rolled back to 50° left.	The aircraft rolled back to 53° left.	The aircraft roll angle reduced to 9° left and then rolled back to 53° left.	Accepted
16	History of Flight (1.1), page 4, 4 th paragraph	The first left side stick input was at 2317:03 UTC for 2 seconds and at 2317:15 UTC another input for 5 seconds, (...).	The second left side stick input was 15 seconds after the first one, at 2317:18 UTC for 2 seconds.	The first left side stick input was at 2317:03 UTC for 2 seconds and at 2317:18 UTC another input for 2 seconds, (...).	Accepted
17	History of Flight (1.1), page 4, 6 th paragraph	The lowest speed recorded was 55 knots. The speed recorded fluctuated at an average of 140 knots until the end of the recording.	These speed values correspond to the ISIS airspeed. The values of the recorded CAS are lower than the ISIS ones.	The lowest ISIS speed recorded was 55 knots. The ISIS speed recorded fluctuated at an average of 140 knots until the end of the recording.	Accepted
18	History of Flight (1.1), page 4, 7 th paragraph	At 2317:41 UTC the aircraft reached the highest altitude of 38,500 feet and the largest roll angle 104° to the left.	This altitude value corresponds to the ISIS altitude. At that time, the value of the recorded altitude is lower than the ISIS one.	At 2317:41 UTC the aircraft reached the highest ISIS altitude of 38,500 feet and the largest roll angle 104° to the left.	Accepted

Comment Reference	Reference chapter, page, paragraph	Commented extract	Reason for proposed change	Proposed amendment	Remarks
19	History of Flight (1.1), page 5, last paragraph	The last data recorded by FDR was at 2320:35 UTC with an airspeed of 83 kts, pitch 20° up, AOA 50° up, roll 8° to left, the rate of descent 8400 ft/minute and the radio altitude was 187 feet.	Some of these values do not correspond to the last data recorded in the FDR.	The last data recorded by FDR was at 2320:35 UTC with an ISIS airspeed of 132kts, pitch 20° up, AOA 50° up, roll 8° to left, the rate of descent 8400 ft/minute and the radio altitude was 118 feet.	Accepted
19b	§1.5.3 The PIC exposure to Rudder Travel Limiter problem Page 9	An engineer came to the cockpit to check and performed trouble shooting on the ECAM. The engineer then reset the Circuit breakers (CBs) of the Flight Augmentation Computer (FAC) 1 and 2, and continued with BITE Test5 (Build in Test) which was satisfactorily resolved.	In addition in multiple occasions the document states that maintenance actions on the RTLU issues were performed (trouble shooting, AFS test, ...) with satisfactory results. As shown by the accident flight these maintenance actions were not adequate to solve the RTLU issue.	An engineer came to the cockpit to check and performed trouble shooting on the ECAM. The engineer then reset the Circuit breakers (CBs) of the Flight Augmentation Computer (FAC) 1 and 2, and continued with BITE Test5 (Build in Test) which was satisfactorily resolved apparently addressed the issue.	Accepted
20	§1.5.3 The PIC exposure to Rudder Travel Limiter problem Page 9	After the aircraft parked, the engineer told the captain to disembark the passengers to wait in the terminal building, since the rectification might take a long time. The engineer checked the ECAM and the trouble shooting manual. The manual stated that the FAC 2 shall be replaced. The engineer noticed that a spare FAC was not available in the maintenance store in Surabaya. The engineer removed the FAC 2 from another aircraft that was grounded, PK-AXV and installed it in PK-AXC.		After the aircraft parked, the engineer told the captain to disembark the passengers to wait in the terminal building, since the rectification might take a long time. The engineer checked the ECAM and the trouble shooting manual. According to him, the manual stated that the FAC 2 shall be replaced. The engineer noticed that a spare FAC was not available in the maintenance store in Surabaya. The engineer removed the FAC 2 from another aircraft that was grounded, PK-AXV and installed it in PK-AXC.	Accepted with rewording
21	Maintenance History related to RTLU (1.6.3), pages 12-17		In this chapter (1.6.3) there is no paragraph that would describe the correct maintenance tasks that should have been done in order to solve the repetitive RTLU problem. Without such a paragraph, the reader could understand that the maintenance was done correctly after the RTLU problem that is not the case.	The BEA suggests to add :The maintenance task depends on the PFR. In this case, on the PFR, the failure messages are "FAC1/RTL ACTR 4CC" or "FAC2/RTL ACTR 4CC".These messages call for the following TSM tasks : - For failure message "FAC1/RTL ACTR 4CC": Task 22-61-00-810-803-A Loss of the Rudder Limiting Function on the FAC1. - For failure message "FAC2/RTL ACTR 4CC": Task 22-61-00-810-804-A Loss of the Rudder Limiting Function on the FAC2. These 2 tasks require to change the electronic module of the RTLU in case of repetitive failures.	Accepted with rewording
22	§1.6.3.1 Maintenance Report 1 (MR1) and Maintenance Report 2 (MR2) Page 13	On 19 December 2014, the repetitive RTLU problem was inserted to MR2. After completion of the scheduled flight, the maintenance personnel performed Auto Flight System (AFS) operational test referring to Aircraft Maintenance Manual chapter 22-96-00-710-001-A with a satisfactory result and the MR2 was considered closed.		"On 19 December 2014, the repetitive RTLU problem was inserted to MR2. After completion of the scheduled flight, the maintenance personnel performed Auto Flight System (AFS) operational test referring to Aircraft Maintenance Manual chapter 22-96-00-710-001-A with a satisfactory result and which apparently addressed the issue. Then the MR2 was considered closed."	Accepted

Comment Reference	Reference chapter, page, paragraph	Commented extract	Reason for proposed change	Proposed amendment	Remarks
23	Page 15 - §1.6.3.3 "PK-AXC Defect 1 year" Report	The rectification of the RTLUs was dominated by resetting computers by either pulling the associated CB or resetting the FAC push button and followed by AFS test	We want to be sure that the reader will not assume that previous actions on CB took place in flight. The action was done on the ground by the maintenance and the problem was not rectified as such.	The rectification workaround solution of the maintenance staff on the RTLUs was dominated by resetting computers by either pulling the associated CB or resetting the FAC push button and followed by AFS test.	Accepted
24	§1.6.3.5 Last Three Day Records Page 16	25 December 2014: After two occurrences of AUTO FLT RUD TRV LIM SYS problem, referring to the ECAM and Trouble Shooting Manual (TSM), the FAC 2 was replaced. The removal and installation of the component referred to AMM 22-66-34 PB 401. DL NOQA/DL/14/01		25 December 2014: After two occurrences of AUTO FLT RUD TRV LIM SYS problem, to the ECAM and Trouble Shooting Manual (TSM), referring only to AFS Test Trouble Shooting Data and the selection of 22-66-00-810-818A procedure, the FAC 2 was replaced. The removal and installation of the component referred to AMM 22-66-34 PB 401. DL NOQA/DL/14/01	Accepted
25	§1.6.3.7 Summary Page 17	An evaluation of the maintenance data showed that the maintenance action following the RTLUs were dominated by resetting the computer by either pulling the associated CB or resetting the FAC push button and followed by an AFS test. The replacement of FAC2 was the only different action taken by the line maintenance personnel.		An evaluation of the maintenance data showed that the maintenance action following the RTLUs were dominated by resetting the computer by either pulling the associated CB or resetting the FAC push button and followed by an AFS test. The replacement of FAC2 was the only different action taken by the line maintenance personnel. The repetitive RTLUs issues would have normally lead to an RTLUs replacement".	Proposal rejected,
26	Weight and Balance (Load and Trim Sheet) (1.6.4), page 17, 3 rd paragraph	The takeoff Mean Aerodynamic Chord (MAC) was 31.5% and the pitch trim was 0.7 down and the MAC of the Zero Fuel Weight (ZFW) was 33.6% indicating that the aircraft was operated within the approved weight and balance envelope.	The percentages given in this paragraph correspond to the position of the Centre of Gravity (CG) with regard to the Mean Aerodynamic Chord (MAC).	The takeoff Centre of Gravity (CG) was 31.5% of the Mean Aerodynamic Chord (MAC) and the pitch trim was 0.7 down and the CG of the Zero Fuel Weight (ZFW) was 33.6% of the MAC indicating that the aircraft was operated within the approved weight and balance envelope.	Accepted
27	Page 22 - §1.6.5.2 Control laws – Side-stick and takeover P/B	In this case, the other not affected flight crewmember must press the side-stick takeover pushbutton for at least 40 s, in order to deactivate the "failed" side-stick	The initial sentence is ambiguous, as the reader could understand that the priority is taken only after 40s, which is not correct.	In this case, the other not affected flight crewmember must press the side-stick takeover pushbutton for at least 40 s, in order to deactivate the "failed" side-stick. deactivate the other stick and take full control by pressing and keeping pressed his priority takeover pushbutton. For latching the priority condition, the pilot must press the takeover push button for more than 40 s. This allows the pilot to release his takeover push button without losing priority.	Accepted
28	Page 24 - §1.6.5.5 The location of FAC1-2 P/B and CB	The location of the FAC 2 circuit breakers was on the circuit breaker panel behind the First Officer's seat.		The location of the FAC 2 circuit breakers was is on the circuit breaker panel behind the First Officer's seat.	Accepted

Comment Reference	Reference chapter, page, paragraph	Commented extract	Reason for proposed change	Proposed amendment	Remarks
29	Page 25/26 - §1.6.5.7 ISIS Schematic	The Air Data and Inertial Reference System (ADIRS) supply the data of temperature, anemometric, barometric and inertial parameters to the EFIS system (PFD and ND) and to other systems. The ADIRS obtained the air data information from 3 (three) Pitot Probes and 6 (six) Static Pressure Probes. Normal pitot and static pressure probes are obtained from Captain and F/O Pitot Probes. The standby information or Integrated Standby Instrument System (ISIS) is obtained from Standby Pitot and Statics Probes	ISIS is a standby indicator, while the paragraph describes the anemometric system in general (the 3 ADIRU + ISIS). So we propose to change the title of this paragraph and some wording.	§1.6.5.7 ISIS Air Data System Schematic The Air Data and Inertial Reference System (ADIRS) supply the data of temperature, anemometric, barometric and inertial parameters to the EFIS system (PFD and ND) and to other systems. The 3 (three) ADIRS obtained the air data information from 3 (three) Pitot Probes and 6 (six) Static Pressure Probes. Normal Primary pitot and static pressure probes are obtained from Captain and F/O Pitot Probes. The standby information or Integrated Standby Instrument System (ISIS) is obtained from Standby Pitot and Statics Probes, common with ADIRU3 .	Accepted
30	Aids to navigation (1.8) Figure 17 Page 29	Figure 17	The figure is not clear enough	A better and clearer figure would be beneficial We propose two possible figures (attached to the mail)	Proposal rejected
31	New section in paragraph 1.11.1	New section		<i>After the following sentence: "The FDR recorded approximately 1200 parameters and about 174 hours of aircraft operation containing 74 flights including the accident flight." We suggest to add:</i> "It had to be noted that in some specific circumstances specific parameters alternations patterns could be recorded and observed on FDR Data. These specific FDR parameter patterns are made to indicate when a data to be recorded is not available at the FDR entry interface. This parameter unavailability could be due to the emitter equipment is set OFF, or de-energized, or due to wiring or other issue making that the information do not arrive at the FDR interface. In such situation for example for FDR binary recorded data, the alternative recording, at each sample, of, at one sample, the minimum parameter value then, at the next sample, the maximum parameter value and so on, indicate this parameter unavailability, as soon as the parameter is not refresh or not provided by the relevant equipment. In particular, this situation was observed when the FAC 1 and the FAC 2 were de-energized during the accident flight."	Accepted with rewording
32	Flight Data Recorder (1.11.1), page 31, 4 th paragraph	Subsequently the aircraft entered a steep turn and climb, eventually reaching high angle of attack, the stall warning activated and continued until the end of the recording.	Information regarding pilot actions is missing in this paragraph. The aircraft entered an upset condition following the 6 th master caution and the autopilot disengagement due to inadequate pilot actions.	Subsequently the aircraft entered a steep turn. The following mishandling resulted in the aircraft climbing , eventually reaching high angle of attack, the stall warning activated and continued until the end of the recording.	Proposal rejected
33	Page 32 - §1.11.1	. [...] All three MCs were followed by pilot	A spike could be considered as an	All three MCs were followed by pilot action	Accepted

Comment Reference	Reference chapter, page, paragraph	Commented extract	Reason for proposed change	Proposed amendment	Remarks
	Flight Data Recorder	action of pressing the FAC push buttons 1 and 2, these are indicated by the spikes of the Yaw Damper (YDF) 1 and 2. [...]	anomaly (erratic change of a parameter). Here when the FAC P/B is put to OFF, the YDF parameter is set to "1", then back to "0" when the FAC P/B is put to ON again. The change of the YDF parameter is thus a consequence of the action on the FAC P/B, but in any case a spike.	of pressing the FAC push buttons 1 and 2, these are indicated by the spikes of a status change of the Yaw Damper Fault (YDF) 1 and 2 parameters.	
34	Flight Data Recorder (1.11.1), page 32, last paragraph	The fifth Master Caution at 2316:30 UTC was triggered by FAC 1 FAULT.	The fifth Master Caution occurred at 2316:29 UTC.	The fifth Master Caution at 2316:29 UTC was triggered by FAC 1 FAULT.	Corrected 2316:28
35	Flight Data Recorder (1.11.1), page 33, 1 st paragraph	At 2316:27 UTC: The fifth Master Caution was triggered by FAC 1 FAULT, and followed by fluctuation of parameters of component controlled by FAC 1 such as RTLU 1, Wind Shear Detection 1 and Rudder Travel Limiter Actuator 1. + Rudder deflected ¹ and ailerons were also deflected.	The fifth Master Caution occurred at 2316:29 UTC + new explanation.	At 2316:29 UTC: The fifth Master Caution was triggered by FAC 1 being de-energized concomitant with FDR signature of unavailability of parameters computed by FAC 1 (FDR parameter alternation between min and max value) FAULT, and followed by fluctuation of parameters of component controlled by FAC 1 such as RTLU 1, Wind Shear Detection 1 and Rudder Travel Limiter Actuator 1 + Rudder deflected to around 0.6° and ailerons were also deflected.	Corrected 2316:28 Proposal rejected
36	Flight Data Recorder (1.11.1), page 33, 1 st paragraph	At 2316:39 the FAC 1 was back to ON and all fluctuating parameters stopped.	This statement is ambiguous and the reader could understand that FAC 1 push-button has been set to ON. Actually, at 2316:39 UTC, it is the FAC 1 Fail parameter that is set to 0, after the FAC 1 C/Bs being pushed. But FAC 1 push-button was not set to ON.	At 2316:39 UTC the FAC 1 was re-energized, meaning that the FAC1 28VDC CB was reengaged. However because the FAC1 pushbutton on overhead panel was not put to OFF then ON, the FAC1 functions remained unavailable, and all parameters alternations stopped.	Proposal rejected
37	Flight Data Recorder (1.11.1), page 33, 1 st paragraph	At 2316:44 UTC, the sixth Master Caution was triggered by FAC 1+2 FAULT and followed by: o Fluctuation of parameters of component controlled by FAC 2 such as RTLU 2, Wind Shear Detection 2 and Rudder Travel Limiter Actuator 2	The sixth Master Caution occurred at 2316:46 UTC + new explanation.	At 2316:46 UTC, the sixth Master Caution was triggered by FAC 1+2 FAULT and followed by: o Fluctuation of parameters of component controlled by FAC 2 FAC 2 also being de-energized concomitant with FDR signature of unavailability of parameters computed by FAC 2 (FDR parameter alternation between min and max value) such as RTLU 2, Wind Shear Detection 2 and Rudder Travel Limiter Actuator 2	Proposal rejected
38	Flight Data Recorder (1.11.1), page 33, 1 st paragraph	At 2316:54 UTC the FAC 2 was back to ON and all fluctuating parameters stopped.	This statement is ambiguous and the reader could understand that FAC 2 push-button has been set to	At 2316:54 UTC the FAC 2 was re-energized, meaning that the FAC2 28VDC CB was reengaged. However because the	Proposal rejected

Comment Reference	Reference chapter, page, paragraph	Commented extract	Reason for proposed change	Proposed amendment	Remarks
	paragraph		ON. Actually, at 2316:54 UTC, it is the FAC 2 Fail parameter that is set to 0, after the FAC 2 C/Bs being pushed. But FAC 2 push-button was not set to ON.	FAC2 pushbutton on overhead panel was not put to OFF then ON, the FAC2 functions remained unavailable. At this stage both FAC1&2 were unavailable, and all parameters alternations stopped. As consequence: - the autopilot and auto thrust could not be engaged, - Flight control law remained in Alternate Law.	
39	Page 34 - §1.11.1 Flight Data Recorder	The FDR graphs for the Calibrated Airspeed (CAS) and altitude (ALT) were taken from the Integrated Standby Instrument System (ISIS) as the data for these two parameters obtained from the normal sources showed unreasonable values.	The FDR records the data from ISIS and the ADIRU1. Until about time 23:17.40 (3mn before impact), ISIS_CAS and ADIRU1_CAS were identical. After this time (extremely high AoA), the CAS from these two units started to be different. The difference is explained by the fact that the sensors used by ADIRU1 are installed in a different area than the ones used by ISIS. Consequently under extremely high AoA conditions the pressure measured by the different sensors could be different.	The FDR graphs for the Calibrated Airspeed (CAS) and altitude (ALT) were taken from the Integrated Standby Instrument System (ISIS) and not the ADIRU1 as the data for these two parameters obtained from the normal source became from a certain time unavailable showed unreasonable values.	Accepted
40	Flight Data Recorder (1.11.1), page 34, 2 nd paragraph (1 st bullet)	At 2316:45 UTC, the autopilot and auto-thrust disengaged and the aircraft started to roll to the left up to 54°.	The autopilot and auto-thrust disengagement occurred at 2316:43 UTC.	At 2316:43 UTC, the autopilot and auto-thrust disengaged and the aircraft started to roll to the left up to 54°.	Accepted
41	Flight Data Recorder (1.11.1), page 34, 2 nd paragraph (3 rd bullet)	At 2316:55 UTC, the right side-stick input was to the left at maximum deflection and the roll back to 50° to the left.	The aircraft rolled back to 53° left.	At 2316:55 UTC, the right side-stick input was to the left at maximum deflection and the aircraft rolled back to 53° to the left.	Accepted
42	Flight Data Recorder (1.11.1), page 35, 1 st paragraph (3 rd bullet)	The first left side stick input was at 2317:03 UTC for 2 seconds, then 12 seconds later another input for 5 seconds, and at 2317:29 the input continued until the end of the recording.	The second left side stick input was 15 seconds after the first one, at 2317:18 UTC for 2 seconds.	The first left side stick input was at 2317:03 UTC for 2 seconds, then 15 seconds later another input for 2 seconds, and at 2317:29 the input continued until the end of the recording.	Accepted
43	Recorded system failure (1.11.2), page 38, table		Two other events occurring in flight are missing in the table: - one loss of RTLU 1+2 during approach, on 20 th December; - onemore loss of RTLU 1+2 during approach, on 21 st December. In addition, the 25 th December event occurring on ground could also be added.	The BEA suggests adding these 3 events in the table.	Accepted
44	§1.11.2 Recorded	On the 19 December 2014, PK-AXC	It is assumed that at this time no C/B	On the 19 December 2014, PK-AXC	Proposal rejected

Comment Reference	Reference chapter, page, paragraph	Commented extract	Reason for proposed change	Proposed amendment	Remarks
	system failure Page 39	operated flights QZ7684, from Jakarta (Soekarno-Hatta) Airport to Surabaya Airport, and QZ7689 from Surabaya Airport to Jakarta (Soekarno-Hatta) Airport. During these two flights the RTLU system faulted twenty two times resulting in a master caution alert. Each RTLU fault was cleared by the crew using the ECAM FAC reset procedure	were used to perform the reset but just the Overhead panel Push button (P/B).	operated flights QZ7684, from Jakarta (Soekarno-Hatta) Airport to Surabaya Airport, and QZ7689 from Surabaya Airport to Jakarta (Soekarno-Hatta) Airport. During these two flights the RTLU system faulted twenty two times resulting in a master caution alert. Each RTLU fault was cleared by the crew using the ECAM FAC overhead pushbutton (P/B) reset procedure	
45	Cockpit Voice Recorder (1.11.3), page 40, CVR transcript	CVR transcripts	The CVR transcript is very reduced	More items identified in the CVR could be added for a better understanding of the event. A complete CVR transcript could be put in appendix. If not, change the introduction which says : <i>"the transcript is as follows :"</i> into <i>"hereafter is an extract from the CVR"</i> .	Proposal rejected
46	Cockpit Voice Recorder (1.11.3), page 41, CVR transcript	2319:58 UTC: the PIC requested to select Display Management Computer to CAPT 3.	This is not consistent with what is written in paragraph 2.6 page 97-98: "(...) the PIC commanded the SIC to select 'CAPT 3' air data source'. Moreover, the BEA understands something similar to: 'captain three' but is not able to clearly understand the meaning of this statement.	2319:58 UTC: the PIC said something similar to "captain three" . Then, the possible meanings of this statement could be analyzed in part 2 of the report (for instance, paragraph 2.6).	Proposal rejected
47	Selected significant events based on CVR and FDR (1.11.4), page 41, 2 nd paragraph	The events initiated when the autopilot (A/P) and auto-thrust (A/THR) disengaged, flight control on Alternate Law without several protections available as on Normal Law which occurred at 2316:44 UTC.	The autopilot and auto-thrust disengagement occurred at 2316:43 UTC.	The events initiated when the autopilot (A/P) and auto-thrust (A/THR) disengaged, flight control on Alternate Law without several protections available as on Normal Law which occurred at 2316:43 UTC.	Accepted
48	Page 41 - §1.11.4 Selected significant events based on CVR and FDR	The speed information is available from two sources. The normal source is from the pitot and static probe (labelled CAS) which is displayed on the instrument. The other source is the standby system or Integrated Standby Instrument System (ISIS) obtained from alternate source pitot and static probes which will be displayed on the instrument when CAPT3 or FO3 selected.	On aircraft there are 3 pitot probes, 6 static ports, 3 ADIRU and 1 ISIS. - Each ADIRU uses its own pitot (x1) and its own static (x2). - ISIS uses the pitot and static probes in common with ADIRU3. However the process of these information by ADIRU3 and ISIS is different. By using the Air Data switching we don't put on PFD the ISIS information but the ADIRU3 information. Same comment for the tables on pages 42 to 44, where we propose to change "CAS" by "PFD" to be coherent with "ISIS".	The speed information is available from two types of devices sources . The normal primary device type source is from the ADIRU (x3) the pitot and static probe (labelled CAS) which is displayed on the PFD instrument. The other device type source is the standby system or Integrated Standby Instrument System (ISIS) obtained from alternate source pitot and static probes which will be displayed on the instrument when CAPT3 or FO3 selected . Under normal functioning: - ISIS parameters are always displayed on ISIS display - ADIRU1 is displayed on PFD1 - ADIRU2 is displayed on PFD2 To display the ADIRU3 parameters on PFD1 or PFD2 the crew has to use the Air Data Switching (CAPT on 3 or F/O on 3).	Accepted
49	Selected significant events based on CVR and FDR (1.11.4), page 41,	Note: Negative (-) pitch value means pitch up and negative (-) roll value means aircraft rolls to the left.	This convention does not correspond to the one used in the tables of the following pages (pages 42-45).	The BEA suggests changing the convention and/or the signs used in the tables of the following pages (pages 42-45).	Accepted

Comment Reference	Reference chapter, page, paragraph	Commented extract	Reason for proposed change	Proposed amendment	Remarks
	4 th paragraph				
50	Selected significant events based on CVR and FDR (1.11.4), page 42, Figure 25 and associated table	Sidesticks: SIC: - P: -15° - R: 0°	The value given for the roll sidestick input by the SIC does not correspond to the one seen on Figure 25.	Sidesticks: SIC: - P: -15° - R: (+/-)19°	Accepted
51	Selected significant events based on CVR and FDR (1.11.4), page 42, table between Figure 25 and Figure 26	23:16:45 UTC: Warning: Auto pilot disengaged followed by cavalry charge (autopilot disengaged warning).	The autopilot disengagement occurred at 2316:43 UTC.	23:16:43 UTC: Warning: Auto pilot disengaged followed by cavalry charge (autopilot disengaged warning).	Accepted
52	Selected significant events based on CVR and FDR (1.11.4), page 42, table between Figure 25 and Figure 26	23:16:53 UTC: P2: "Oh my God".	The CVR spectral analysis performed at the BEA shows that it is the PIC (P1) who said "Oh my God" at that time.	23:16:53 UTC: P1: "Oh my God".	Accepted
53	Selected significant events based on CVR and FDR (1.11.4), page 42, table between Figure 25 and Figure 26	23:16:54 UTC: The FAC 2 back ON.	This statement is ambiguous and the reader could understand that FAC 2 push-button has been set to ON. Actually, at 2316:54 UTC, it is the FAC 2 Fail parameter that is set to 0, after the FAC 2 C/Bs being pushed. But FAC 2 push-button was not set to ON.	23:16:54 UTC: the FAC 2 was re-energized meaning that the FAC2 28VDC CB was reengaged. However because the FAC2 pushbutton on overhead panel was not put to OFF then ON, the FAC2 functions remained unavailable.	Accepted with rewording
54	Selected significant events based on CVR and FDR (1.11.4), page 42, table between Figure 25 and Figure 26	23:16:55 UTC: Warning: Stall warning activated for 1 second.	The first Stall warning occurred at 2316:56 UTC.	23:16:56 UTC: Warning: Stall warning activated for 1 second.	Accepted
55	Selected significant events based on CVR and FDR (1.11.4), page 43, table between Figure 26 and Figure 27	2317:20 UTC: P2: Stated "stall".	This « stall » can't be identified at the BEA	We propose to delete this sentence.	Accepted
56	Selected significant events based on CVR and FDR (1.11.4), page 43, Figure 27	Figure 27: The aircraft attitude at the highest pitch angle.	The time indicated on Figure 27 is 23:17:25 UTC, but in the FDR data, the highest pitch angle is at 2317:32 UTC.	The BEA suggests replacing the animation snapshot of Figure 27 with the equivalent one at 23:17:32 UTC and modifying the values in the associated table.	Accepted
57	Selected significant	Figure 29: Attitude recovered.	The animation snapshot does not	The BEA suggests replacing the animation	Accepted

Comment Reference	Reference chapter, page, paragraph	Commented extract	Reason for proposed change	Proposed amendment	Remarks
	events based on CVR and FDR (1.11.4), page 44, Figure 29		come from the last version of the animation.	snapshot of Figure 29 with the equivalent one from the last version of the animation.	
58	Selected significant events based on CVR and FDR (1.11.4), page 45, table following Figure 29	2319:58 UTC: P1 to P2: Instructed to select to CAPT 3.	This is not consistent with what is written in paragraph 2.6 page 97-98: "(...) the PIC commanded the SIC to select 'CAPT 3' air data source'. Moreover, the BEA understands something similar to: "captain three" but is not able to clearly understand the meaning of this statement.	2319:58 UTC: P1 to P2: Said something similar to "captain three". Then, the possible meanings of this statement could be analyzed in part 2 of the report (for instance, paragraph 2.6).	Proposal rejected
59	Page 50 - 1.16 Tests and Research 1.16.1 Flight Simulation 1	No commented extract. Insertion proposed.	It would be useful to insert, between 1.16 and 1.16.1 a statement on the limits of stall representativity on simulators	To be inserted : Training simulators are representative only within the certified flight envelop. Simulations performed beyond this envelop cannot be considered as valid for the analysis of this accident.	Proposal rejected
60	Page 50 - §1.16.1 Flight Simulation 1	Pilots acted as crewmember during this simulation was a qualified Airbus A320 pilot and a KNKT investigator with Boeing B737 NG pilot background who acted as Pilot Flying.	As the sentence is written, it let assume that it was a pilot from Airbus, which was not the case.	Pilots acted as crewmember during this simulation was a pilot qualified on Airbus A320 pilot and a KNKT investigator with Boeing B737 NG pilot background who acted as Pilot Flying.	Proposal rejected
61	Flight Simulation 1 (1.16.1), page 50, Figure 33	Figure 33: Display of the ECAM message during RTLU 1+2 malfunction	The ECAM message displayed on Figure 33 contains FAC 1 FAULT that does not correspond to RTLU 1+2 malfunction.	The BEA suggests replacing the ECAM message displayed on Figure 33 with the one corresponding to RTLU 1+2 malfunction only (cf. document "Flight synopsis-phase1-withECAM" provided to KNKT during the meeting of July 2015).	Accepted
62	Flight Simulation 1 (1.16.1), page 51	Figure 36 + During stall the PFD indicated: - Flight director commanded to set pitch up (climb); - Vertical Speed Indicator indicated down; - Speed below stalling speed.	This paragraph is ambiguous and the reader could understand that the statements of these three bullets and what is seen on Figure 36 represent exactly what happened during the accident flight. The behavior of the aircraft in a situation of stall at high angle of attack is not known. Therefore the the are are not representative at all of the real aircraft in a situation of a developed stall and cannot serve as a reference in this investigation.	The BEA suggests to suppress the figure 36 and the following sentences : During stall the PFD indicated: Flight director commanded to set pitch up (climb); Vertical Speed Indicator indicated down; Speed below stalling speed.	Accepted
63	RTLU examination 1.16.3 P 53	According to the Airbus information, there were three symptoms regarding the AUTO FLT RUD TRV LIM 1(2) (SYS) problem	To be more precise on the TFU history	According to the Airbus information, there were three symptoms Technical Follow-Up (TFU) regarding the AUTO FLT RUD TRV	Accepted

Comment Reference	Reference chapter, page, paragraph	Commented extract	Reason for proposed change	Proposed amendment	Remarks
		since 1993. The Technical Follow-Up (TFU) No. 27.23.51.004 was opened in 1993 regarding the problem and closed on 1996. The problem found was "Fatigue rupture of soldering" and the improvement made was "New electronic module". Another TFU 27.23.00.004 was opened in 2000 with the same problem of "Rupture of soldering" and closed in 2014 with the improvement made was "Electronic board process" which was available since 2002. The Airbus informed that the installed RTLU on PK-AXC has been improved with both Technical Follow-ups (TFUs).		LIM 1(2) (SYS) problem that were issued since 1993. The TFU No. 27.23.51.004 was opened in 1993 regarding the problem « Fatigue rupture of soldering » and closed on 1996. The improvement made was "New electronic module". Another TFU (27.23.00.004) was opened in 2000 with the same problem of "Rupture of soldering" and closed in 2014 with the improvement made was of the "Electronic board process" which was available since 2002. The third TFU (n° 27.23.00.007) "Mechanical stop failure" opened in January 2015 doesn't apply to this aircraft. The Airbus informed that the installed RTLU on PK-AXC has had been improved with both Technical Follow-ups (TFUs).	
64	Standard operating procedures 1.17.3.8 Pages 72-73	Pages 72-73	The report does not indicate the operator's SOP 4.10.3.4 flight tolerance deviation in cruise : « When flight tolerances are exceeded without initiation of an appropriate correction, the PM shall notify the PF using the specific calls : - "Speed: for excursions +/- 10 kt or M0.02 - "Altitude: for excursions +/- 100 ft.	The BEA proposes to add the speed and altitude deviation callouts to the paragraph.	Accepted with rewording
65	Rudder deflection (1.18.3), page 84, complete paragraph	Complete paragraph.	Further to a deeper analysis, the first information given during March 2015 meeting has been updated (cf. document "QZ8501 – Rudder movement, Reference: 420-1139/15, Issue 01"). However please note that this document ("QZ8501 – Rudder movement, Reference: 420-1139/15, Issue 01") is considered as an Airbus/Thales confidential design, meaning that it is provided has a help to the KNKT to understand the phenomenon, but it has not to be given to a third party nor to be put in a public report.	The BEA suggests modifying this paragraph as: <i>When the 26VAC C/Bs of both FAC were pulled, the loss of the 26VAC was detected by the FAC monitoring. However the FAC logic associated to the computation time and rudder movement inertia created a rudder movement of about 2". As both FAC were unavailable this rudder movement was not automatically compensated.</i>	Accepted
66	Analysis (2), page 88, 2 nd paragraph	Furthermore, the records also showed that the interval of the malfunctions became shorter in the last 3 months even though maintenance actions had been performed since the first malfunction was identified in January 2014.	This statement is ambiguous and could lead the reader to understand that despite the maintenance actions that were correctly performed, the malfunctions re-appeared more often.	Furthermore, the records also showed that the interval of the malfunctions became shorter in the last 3 months <i>and that inadequate</i> maintenance actions had been performed since the first malfunction was identified in January 2014.	Proposal rejected

Comment Reference	Reference chapter, page, paragraph	Commented extract	Reason for proposed change	Proposed amendment	Remarks
			This comment has to be linked with comment 47 above.		
67	Page 88/89 - §2.1 Un-commanded aircraft roll			We propose to mention that when the FAC1 FAULT was triggered, the crew did not follow the ECAM procedure asking to reset the FAC1 through the overhead push button. Same comment when FAC1+2 FAULT was triggered.	Proposal rejected
68	Un-commanded aircraft roll (2.1), page 88, 1 st paragraph	Between 2301 UTC to 2313 UTC the FDR and CVR recorded three "AUTO FLT RUD TRV LIM SYS" failures and triggered the chime and master caution (...).	The ECAM message AUTO FLT RUD TRV LIM SYS is not directly recorded in the FDR. The analysis of the FDR recorded parameters showed that this ECAM message was triggered.	Between 2301 UTC to 2313 UTC the FDR and CVR recordings indicate that three rudder travel limiter system failures occurred and triggered the chime and master caution (...).	Accepted
69	Un-commanded aircraft roll (2.1), page 88, 3 rd paragraph	At 2316:29UTC, the FDR recorded the ECAM message of FAC 1 FAULT which triggered the 5 th master caution. Sixteen seconds later the FDR recorded ECAM message FAC 1+2 FAULT which triggered the 6 th master caution, (...).	The ECAM message FAC 1 FAULT and FAC 1+2 FAULT are not directly recorded in the FDR. The analysis of the FDR recorded parameters showed that these ECAM messages were triggered. Moreover, in order to be consistent with times indicated in chapters 1.1 and 1.11.1, the 6 th master caution occurred seventeen seconds after the 5 th one (as stated at the beginning of the 3 rd paragraph of chapter 2.1).	At 2316:29 UTC, the FDR recorded parameters which indicate that FAC 1 was de-energized leading to the ECAM FAC 1 FAULT message associated with the 5 th master caution. Seventeen seconds later the FDR recorded parameters indicate that FAC 2 was also de-energized leading to the FAC 1+2 FAULT message associated with the 6 th master caution, (...)	Accepted
70	Un-commanded aircraft roll (2.1), page 89, 1 st paragraph	The fault on FACs was associated with electrical interruption due to loss of 26VAC and 28VDC.	This statement is ambiguous and the reader could understand that the FAC faults were due to a failure in the aircraft's electrical system. It was demonstrated during the investigation that the electrical interruption of the FACs was likely caused by the FACs 26VAC and 28VDC CBs being pulled. This is well explained in the following chapter (2.2) and it would be useful for the reader to state it in chapter 2.1 as well.	The ECAM message FAC1+2 FAULT was associated with both FACs electrical interruptions which was likely due to the FACs CBs being pulled.	Proposal rejected
71	Un-commanded aircraft roll (2.1), page 89, 1 st paragraph	Refer to the information provided by the Airbus, there was a software confirmation time of 245ms before shutting-down the Rudder Trim electrical motor. The maximum speed of the Rudder Trim electrical motor is 5°/s, where the acquisition time inside the FAC is every 35ms. The electrical interruption caused a 1.4° rudder deflection.	Further to a deeper analysis, the first information given during March 2015 meeting has been updated (cf. document "QZ8501 – Rudder movement, Reference: 420-1139/15, Issue 01"). However please note that this document ("QZ8501 – Rudder movement, Reference: 420-1139/15, Issue 01") is considered as an Airbus/Thales confidential design.	The BEA suggests modifying this paragraph as: Refer to the information provided by Airbus when the 26VAC C/Bs of both FAC were pulled, the loss of the 26VAC was detected by the FAC monitoring. However the FAC logic associated to the computation time and rudder movement inertia created a Rudder movement of about 2°. As both FAC were disengaged this rudder movement was not automatically	Accepted with rewording

Comment Reference	Reference chapter, page, paragraph	Commented extract	Reason for proposed change	Proposed amendment	Remarks
			meaning that it is provided has a help to the KNKT to understand the phenomenon, but it has not to be given to a third party nor to be put in a public report.	compensated.	
72	§2.1 Uncommanded aircraft roll Page 89	The FDR recorded that when FAC 1 fault, the rudder deflected 0.9°, at this time the auto-pilot was still engaged as the FAC 2 took over the function of FAC 1.		The FDR recorded that when FAC 1 fault was de-energized, the rudder deflected of about 0.6° 0.9°. At this time the auto-pilot was still engaged as the FAC 2 took over the function of FAC 1.	Accepted
73	§2.1 Uncommanded aircraft roll Page 89	Seventeen seconds after the FAC 1 fault, the FDR recorded that after the FAC 2 fault, the A/P and A/THR disengaged, Normal Law converted to Alternate Law, and rudder deflected 2° to the left causing the aircraft rolled to the left with rate of 6°/second.		Seventeen seconds after the FAC 1 fault, the FDR recorded that after the FAC 2 fault, was de-energized but not re-engaged, the FDR recorded that the FAC 2 was also re-energized but also not re-engaged. As a consequence the A/P and A/THR disengaged, Normal Law converted to Alternate Law, and rudder deflected 2° to the left causing the aircraft rolled to the left with rate of 6°/second.	Accepted
74	Un-commanded aircraft roll (2.1), page 89, 5 th paragraph	In Normal Law the aircraft is protected by roll protection logic to not exceed 33°. However the protection is not available in Alternate Law.	This sentence could make the reader believe that the aircraft bank cannot exceed 33° in Normal Law, which is not the case. Bank is limited to 67°. In fact, in Normal Law, even with rudder deflected, without an action on the side-stick, the flight control would have corrected the roll tendency due to rudder deflection	The BEA suggests to write « in Normal Law, without crew input, with the rudder deflected, flight control tend to maintain a zero roll rate. This is not the case in Alternate Law, which in the same circumstances, allows the bank to increase without protection. »	Accepted
75	Electrical interruption (2.2), page 89	At 2316:29UTC, the FDR recorded the ECAM message of FAC 1 FAULT which triggered the 5 th master caution. At this time, the FDR also recorded rudder deflection of 0.9°, FAC 1 OFF, fluctuation on the following parameters: Rudder Travel Limited Unit (RTL) 1, wind shear detection 1 and Rudder Travel Limiter Actuator 1. At 2316:38 UTC, the FDR recorded the FAC 1 back ON.	The ECAM message FAC 1 FAULT is not directly recorded in the FDR. The analysis of the FDR recorded parameters showed that this ECAM message was triggered.	At 2316:29 UTC, the FDR recorded parameters which indicate that FAC 1 was de-energized leading to the ECAM FAC 1 FAULT message associated with the 5 th master caution. At this time, the FDR also recorded a rudder deflection of about 0.6° FAC 1 OFF de-energized situation lead to the unavailability of the following parameters (observable by parameter alternation between min and max value) :Rudder Travel Limited Unit (RTL) 1, wind shear detection 1 and Rudder Travel Limiter Actuator 1.	Accepted
76	Electrical interruption (2.2), page 89, 1 st paragraph	At 2316:38 UTC, the FDR recorded the FAC 1 back ON.	This statement is ambiguous and the reader could understand that FAC 1 push-button has been set to ON. Actually, at 2316:39 UTC (as indicated in chapter 1.11.1 page 33),	At 2316:39UTC the FAC 1 was re-energized meaning that the FAC1 28VDC CB was reengaged. However because the FAC1 pushbutton on overhead panel was not put to OFF then ON, the FAC1 functions remained unavailable.	Accepted with rewording

Comment Reference	Reference chapter, page, paragraph	Commented extract	Reason for proposed change	Proposed amendment	Remarks
			it is the FAC 1 Fail parameter that is set to 0, after the FAC 1 C/Bs being pushed. But FAC 1 push-button was not set to ON.		
77	Electrical interruption (2.2), page 89, 2 nd paragraph	At 2316:45 UTC, the FDR recorded the ECAM message of FAC 1+2 FAULT which triggered the 6th master caution and followed by: 1. Autopilot and Auto-thrust disengaged; 2. Rudder deflection 2° to the left; 3. FAC 2 OFF; 4. Fluctuation of parameters: Travel Limited Unit (RTL) 2, Rudder Travel Limiter Actuator 2, wind shear detection 2 5. Flight control status reverted from Normal Law to Alternate Law 6. Aircraft started to roll to the left. At 2316:53 UTC, the FDR recorded the FAC 2 ON.	The ECAM message FAC 1+2 FAULT is not directly recorded in the FDR. The analysis of the FDR recorded parameters showed that this ECAM message was triggered. Moreover, the sixth Master Caution occurred at 2316:46 UTC.	At 2316:46 UTC, the FDR recorded parameters indicate that FAC 2 was also de-energized leading to the FAC 1+2 FAULT message associated with the 6 th master caution and followed by 1. Autopilot and Auto-thrust disengaged; 2. Rudder deflection 2° to the left; 3. FAC 2 de-energized situation lead to the unavailability of the following parameters (observable by parameter alternation between min and max value): Travel Limited Unit (RTL) 2, Rudder Travel Limiter Actuator 2, Wind Shear detection 2 4. Flight control status reverted from Normal Law to Alternate Law (as both FACs were not re-engaged through the Overhead panel Push button reset) 5. Aircraft started to roll to the left.	Accepted with rewording
78	Electrical interruption (2.2), page 89, 3 rd paragraph	At 2316:53 UTC, the FDR recorded the FAC 2 ON.	This statement is ambiguous and the reader could understand that FAC 2 push-button has been set to ON. Actually, at 2316:54 UTC (as indicated in chapter 1.11.1 page 33), it is the FAC 2 Fail parameter that is set to 0, after the FAC 2 C/Bs being pushed. But FAC 2 push-button was not set to ON.	At 2316:54 UTC the FAC 2 was re-energized meaning that the FAC2 28VDC CB was reengaged. However because the FAC2 pushbutton on overhead panel was not put to OFF then ON, the FAC2 functions remained unavailable.	Accepted with rewording
79	§2.2 Electrical interruption Page 89 and 90	The examination of the fluctuation of FDR parameters signature was similar to that of the flight on 25 December 2014, when the aircraft had RTL problem on the ground and the CBs were reset by pulling out and pushing back in.		The examination of the fluctuation of FDR parameters signature was similar to that of the flight on 25 December 2014, when the aircraft had RTL problem on the ground and the CBs were reset by pulling out and pushing back in.	Accepted
80	Electrical interruption (2.2), page 90	The FDR recorded that the FAC back ON. It indicated that the CBs had been pushed back in. The FAC has two CBs which were 26 V AC and 28 V DC. A CB may pop out when electrical short circuit occurs, however to push back in cannot be automatic, it requires human input. Returning FAC CB back in during flight does not automatically recover the function of the FAC, it requires resetting the FAC	This statement is ambiguous and the reader could understand that FACs push-buttons have been set to ON. Actually, the FAC 1(2) Fail parameter is set to 0, after the FAC 1(2) C/B being pushed. But FAC 1(2) push-button was not set to ON.	The FDR recorded that the FACs were re-energized meaning that the FACs 1&2 28VDC CB were reengaged. However because the FACs 1&2 pushbuttons on overhead panel were not put to OFF then ON, the FACs 1&2 functions remained unavailable. It indicated that the CBs had been pushed back in. The FAC has two CBs which were 26 V AC and 28 V DC. A CB may pop out when electrical short circuit	Accepted

Comment Reference	Reference chapter, page, paragraph	Commented extract	Reason for proposed change	Proposed amendment	Remarks
		push button as mentioned on ECAM Procedures. Without resetting the FAC pushbutton the FAC and all related systems remain inactive even though the FDR shows the FAC parameter back ON		occurs, however to push back-in cannot be automatic, it requires human input. Returning FAC CB back-in during flight does not automatically make that FAC functions to be re-engaged it requires resetting the FAC push button as mentioned on ECAM Procedures. Without resetting the FAC pushbutton the FAC and all related systems remain not engaged even though the FDR shows the some FAC FDR parameters are re-computed and recorded *	
81	Electrical interruption (2.2), page 90, 4th paragraph	<p>The FDR data recorded that the continuous inputs on the left side stick was initiated at 2317:28 UTC or 33 seconds after the FDR recorded FAC 2 parameter back ON.</p> <p>During this time, the aircraft was climbing and when passing 33900 feet the AOA reached 21° triggered the first aural Stall Warning. At 36000 feet the AOA reached 25°, roll angle 0, speed 150 knots, which met the criteria of upset condition and required the pilots to recover.</p>	<p>The first aural Stall Warning was at 2316:56 UTC when the AOA reached 8° (that is the threshold of the Stall Warning).</p> <p>When the Stall Warning is triggered, the pilot flying is required to apply the Stall Recovery procedure, that is, in the case of this accident, well before the upset condition criteria described in this paragraph.</p>	<p>The FDR data recorded that the continuous inputs on the left side stick was initiated at 2317:28 UTC or 33 seconds after the FDR recorded FAC 2 parameters are re-computed and recorded.</p> <p>During this time, the aircraft was climbing and when passing 33900 feet the AOA reached 21° triggered the first aural Stall Warning. At 36000 feet the AOA reached 25°, roll angle 0, speed 150 knots, which met the criteria of upset condition and required the pilots to recover.</p> <p>After the first pitch up inputs of the Pilot Flying, the aircraft started to climb and the AOA increased. When it reached 8°, at 2316:56 UTC, the first aural Stall Warning triggered, requiring the Pilot Flying to apply the Stall Recovery procedure.</p>	Accepted
82	Electrical interruption (2.2), page 90, 6th paragraph	The intermittent failure of RTLU triggered the ECAM message of FAC FAULT.	The FACs faults were caused by the FACs C/Bs likely being pulled.	The intermittent failure of RTLU triggered the ECAM message AUTO FLT RUD TRV LIM SYS .	Accepted
83	Page 90 - §2.3 In-Flight trouble shooting	The ECAM message of RUD TRV LIM SYS, the action was to push the FAC button OFF then ON one by one.	Missing word	The ECAM message of RUD TRV LIM SYS, the action was to push the FAC push button OFF then ON one by one.	Accepted
84	In-flight trouble shooting (2.3), page 91, 1st paragraph	This phenomenon is called procedure memory ¹³ .	The note 13 is missing at the bottom of page 91.		Accepted
85	In-flight trouble shooting p 91 § 2.3	The investigation considered that the statement was potentially ambiguous..... interpretation	<p>The QRR wording should not be considered alone and in an isolated context.</p> <p>According to the manufacturer's and the operator's philosophy, crews are trained in the simulator and on the line only to reset CBs that are listed</p>	The BEA proposes to suppress this statement.	Accepted

Comment Reference	Reference chapter, page, paragraph	Commented extract	Reason for proposed change	Proposed amendment	Remarks
			<p>in the QRH. Crews are made aware of this « good practice » in training.</p> <p>Pulling CBs in flight following a maintenance ground procedure, even if successful on ground, can be considered as a deviation to SOPs.</p> <p>The only valid documentation is the flight crew documentation (ex FCOM FCTM). Verbal indication of maintenance is not expected to supersede the official flight crew documentation.</p>		
86	In-flight trouble shooting p 91 § 2.3	<p>In the case of a failure occurs and the pilot willing postpone to solve the problem and decided to continue the flight other than during take-off or go-around, several buttons on the ECAM panel may be used such as EMER CANC (emergency cancel) button and CLR (clear) button. The EMER CANC button is to cancel (stop) an aural warning for as long as the failure condition continues and extinguish the master warning lights. Activation of this button will not affect the ECAM message display a malfunction other than the system that has been cancelled will be displayed on the ECAM. The simulation showed that activation of Emergency Cancel button was effective to prevent pilot distraction by a repetitive malfunction of RTLU. The FCOM noted that this pushbutton should only be used to suppress spurious master cautions and the QRH mentions activation of EMER CANC button was only for landing gear not down warning.</p>	<p>The crew could have used the "CLEAR" button to clear the ECAM message without performing the ECAM actions.</p>	<p>In the case of a failure occurs and the pilot willing postpone to solve the problem and decided to continue the flight other than during take-off or go-around, several buttons on the ECAM panel may be used such as EMER CANC (emergency cancel) button and CLR (clear) button. The EMER CANC button is to cancel (stop) an aural warning for as long as the failure condition continues and extinguish the master warning lights. Activation of this button will not affect the ECAM message display a malfunction other than the system that has been cancelled will be displayed on the ECAM. The simulation showed that activation of Emergency Cancel button was effective to prevent pilot distraction by a repetitive malfunction of RTLU. The FCOM noted that this pushbutton should only be used to suppress spurious master cautions and the QRH mentions activation of EMER CANC button was only for landing gear not down warning. If the failure re-occurs, the crew can use the CLEAR button. Activation of this button will clear the ECAM message without performing the ECAM action.</p>	Proposal rejected
87	Page 92 - §2.3 In-flight troubleshooting	<p>Having unsuccessful result after taking the ECAM actions with the ambiguous statement in QRH and the experience of seeing the FAC CBs reset on ground might have made the pilot elected to reset the FAC CBs in flight.</p>	See comment 85	<p>Having unsuccessful result after taking the ECAM actions with the ambiguous statement in QRH and the experience of seeing the FAC CBs reset on ground might have made the pilot elected to reset the FAC CBs in flight.</p>	Poposal rejected

Comment Reference	Reference chapter, page, paragraph	Commented extract	Reason for proposed change	Proposed amendment	Remarks
88	Side stick inputs (2.4), page 92, last paragraph	The FDR recorded that the right side stick input was resulted to the aircraft roll to 9° to the left then to 50° to the left and the aircraft climbing.	The aircraft rolled back to 53° to the left.	The FDR recorded that the right side stick input was resulted to the aircraft roll to 9° to the left then to 53° to the left and the aircraft climbing.	Accepted
89	Side stick inputs (2.4), page 93, 1 st paragraph	The CVR recorded the SIC said "oh my God", expressing surprise.	The CVR analysis performed at the BEA shows that it is the PIC who said "Oh my God" at that time. In that case it is not relevant to refer to this statement in this paragraph.	The BEA suggests suppressing this statement in this paragraph.	Accepted with rewording
90	Side stick inputs (2.4), page 93, 2 nd paragraph	The SIC may have experienced spatial disorientation and over-corrected by shifting the side stick to the left which caused the aircraft to roll back to the left up to 50°.	The aircraft rolled back to 53° to the left.	The SIC may have experienced spatial disorientation and over-corrected by shifting the side stick to the left which caused the aircraft to roll back to the left up to 53°.	Accepted
91	First Aural Stall warning (2.4.1), page 93, 1 st paragraph	This will provide sufficient margin to alert the flight crew in advance of the actual stall which will occur at 15° AOA.	The value of 15° AOA is not consolidated and cannot be used in the report.	This will provide sufficient margin to alert the flight crew in advance of the actual stall which will occur at 15° AOA.	Accepted
92	Page 94 - §2.4 Second Aural Stall Warning	The average of the side stick inputs recorded on the FDR since the A/P and A/THR disengaged until the aircraft encountered the second stall warning indicated that both side stick inputs commanded nose up pitch.	More precision needed	The average of the side stick inputs recorded on the FDR since the A/P and A/THR disengaged until the aircraft encountered the second stall warning indicated that the SIC was pulling almost full back stick while the PIC was slightly pushing nose-down. The sum of both side stick inputs commanded nose up pitch.	Accepted
93	Second Aural Stall Warning (2.4.2), page 94, 4 th and 5 th paragraphs	The aircraft system and the pilot training were intended to prevent AOA reaching 15° to avoid stall. The condition of AOA exceeding 15° was beyond pilot training competency as they never been trained or experienced.	The value of 15° AOA is not consolidated and cannot be used in the report.	The aircraft system and the pilot training were intended to prevent AOA reaching high values to avoid stall. The condition of AOA exceeding high values was beyond pilot training competency as they never been trained or experienced.	Accepted
94	Page 94/95 – Pilot recognition of stall	The condition of stall at zero pitch was never been trained to pilot as the training for stall is always on high pitch attitude. The pilot might have not recognized the high AOA as the AOA was not indicated in the cockpit.	During the training, the approach to stall is initiated by a progressive deceleration toward the stall. This will have for effect to increase the AoA and the pitch. Later on, after the aircraft has stalled (still high AoA) and the pitch decreased, the simulators are no longer representative as the aircraft is outside the certified and known flight domain. The fact that there is no AoA indicator does not mean that there is no way to detect the stall. The crew is alerted by the stall warning and the buffet when approaching to the stall. The CVR has recorded both the stall warning and the buffet.	The condition of stall at zero pitch was never been trained to pilot as the training for stall is always on high pitch attitude. The pilot might have not recognized the high AOA as the AOA was not indicated in the cockpit, despite the stall warning and the buffet.	Accepted

Comment Reference	Reference chapter, page, paragraph	Commented extract	Reason for proposed change	Proposed amendment	Remarks
			<p>The FCOM (Abnormal and emergency procedures) mentions the following: <i>As soon as any stall indication (could be aural warning, buffet...) is recognized, apply the immediate Actions: [...]</i></p>		
95	<p>Pilot recognition of stall (2.5), page 96, last two paragraphs</p>	<p>In response to the safety recommendation, the BEA advised that both the FAA and EASA agreed to consider the recommendation and report back on any actions.</p> <p>The events in the accident involving PK-AXC were similar to that in AF447, in that the flight crew did not recognise the approach to stall or apply appropriate control inputs to prevent the aircraft from departing the flight envelope and entering a deep stall¹⁷, even though the audible stall warning activated and remained on for the final segment of the flight. As such, the NTSC supports the intent of the BEA Safety Recommendation.</p>	<p>It would be more adequate to mention here the follow-ups to the BEA's recommendation</p>	<p>In response to the safety recommendation, the BEA advised that both the FAA and EASA agreed to consider the recommendation and report back on any actions.</p> <p>The events in the accident involving PK-AXC were similar to that in AF447, in that the flight crew did not recognise the approach to stall or apply appropriate control inputs to prevent the aircraft from departing the flight envelope and entering a deep stall developed stall condition well beyond AOA stall, even though the audible stall warning activated and remained on for the final segment of the flight.</p> <p>On 24th April 2013 the EASA answered the following :</p> <p><i>It is agreed that providing Angle of Attack (AoA) based information can improve pilot awareness to help avoid loss of control due to aerodynamic stall.</i></p> <p><i>Although a direct AoA indicator may improve flight crew awareness in some specific circumstances, such as in proximity to a stall, the installation/presence of it in the cockpit would necessitate specific flight crew training. Having an additional gauge to monitor would also marginally increase pilot workload in regular flying where the information is of little benefit.</i></p> <p><i>Providing AoA values directly is only one way of presenting information ; AoA based information can also be presented on airspeed scales (such as speed bands on Airspeed scales). This information can be presented even if the airspeed itself has become invalid. In this way, the AoA information is less prone to misinterpretation, does not require another gauge to be monitored, and uses scales with which pilots are already familiar.</i></p> <p><i>Thus in the absence of research data to the</i></p>	Accepted

Comment Reference	Reference chapter, page, paragraph	Commented extract	Reason for proposed change	Proposed amendment	Remarks
				<p>contrary, we support the presentation of AoA derived information but we do not support the direct display of AoA values.</p> <p>The Agency is involved in a working group together with other regulatory agencies and aircraft manufacturers whose aim is to review the current low speed/energy awareness concepts in order to determine whether or not the existing regulation need to be amended and whether there is a need for retrofit of the existing fleet (Avionic System Harmonisation Working Group).</p> <p>In conclusion, the NTSC supports the work in progress following the BEA Safety Recommendation.</p>	
96	Crew Resource Management (2.6), page 96, 4 th paragraph	The 5th master caution illuminated followed by ECAM message of AUTO FLT FAC 1+2 FAULT.	The ECAM message AUTO FLT FAC 1+2 FAULT was triggered after the 6th master caution.	The 6th master caution illuminated followed by the AUTO FLT FAC 1+2 FAULT ECAM message.	Accepted
97	Page 96 - §2.6 Crew resource management	The consequences of resetting the FAC CB might have not been anticipated by the pilots	It is obvious that if they had anticipated the consequences they would have reset the FAC1 through the overhead panel P/B prior pulling FAC2 CB.	The consequences of resetting the FAC CB were not anticipated by the pilots.	Proposal rejected
98	Crew resource management p 97 § 2.6	During this period the CVR data was unintelligible.	<p>The CVR records no conversation, and is not more unintelligible at this moment than some others.</p> <p>The discussion should have included a review of allowed CBs to be reset in flight or in the TDU or OEB table.</p> <p>The crew has already concluded there are no resets after the First ECAM (at 23h02min 12 : F/O says « any computer reset ? , and the PIC replies at 23h02min 44 « no computer reset ».</p> <p>Therefore, the BEA assumes there is no conversation at all before the PIC resets the FAC CBs.</p>	<p>During this period the CVR data was unintelligible.</p> <p>During this period no communication between the SIC and PIC can be heard on the CVR data</p>	Proposal rejected
99	Crew resource management p 97 § 2.6	The PIC commands did not clearly specify the targets (roll, pitch) or the action to achieve them. These might have contributed to the inappropriate action by the SIC. The standard operating procedures, SOPs,	Inadequate statement. As mentioned in the operator SOP, there are call outs above 10 000 ft.	There are call outs above 10 000 ft. Speed (+/- 10 kt), altitude (+/- 100 ft). None of those call outs were made when those parameters were exceeded consecutively to the high pitch. Moreover the PIC commands did not specify	Accepted with rewording

Comment Reference	Reference chapter, page, paragraph	Commented extract	Reason for proposed change	Proposed amendment	Remarks
		contain Standard Call Out, that are applicable for operation below 10,000 feet. The Standard Call Outs for the pitch correction, either for pitch up or pitch down, was "PITCH, PITCH" if the pitch angle reaches 10°, and for roll was "BANK, BANK" if the bank angle reaches 7°. There are no applicable Standard Call Outs for operation above 10,000 feet.		the targets (roll, pitch) or the action to achieve them. These might have contributed to the inappropriate action by the SIC. The standard operating procedures, SOPs, contain Standard Call Out that are applicable for operation below 10,000 feet. The Standard Call Outs for the pitch correction, either for pitch up or pitch down, was "PITCH, PITCH" if the pitch angle reaches 10°, and for roll was "BANK, BANK" if the bank angle reaches 7°. There are no applicable Standard Call Outs for operation above 10,000 feet.	
100	§2.6 Crew Resource Management Page 97	The ineffective crew communication prior to the decision to reset the CB and the subsequent ambiguous commands might have caused the deviation from the goal of solving the aircraft system malfunction and correcting the aircraft condition.	This assertion is confusing in melting Crew actions on CB then their actions on the side sticks (flight controls). Please separate the two notions	The ineffective crew communication prior to the decision to reset the CB might have caused the deviation from the goal of solving the aircraft system issue. Then subsequent inadequate communication might have also caused the deviation from the goal of correcting the aircraft flying trajectory.	Accepted with rewording
101	Crew Resource Management (2.6), page 97, 7 th paragraph	This condition occurred during the dual input while the aircraft was in a deep stall.	Per definition, "deep stall" means a stall condition so that the THS is no longer able to pitch-down the aircraft. Beyond the limit of the known flight domain (explored in flight tests) the behavior of the aircraft is unknown.	This condition occurred during the dual input while the aircraft was in a developed stall condition well beyond AOASTall.	Accepted
102	Page 97 - §2.6 Crew Resource Management (Crew coordination)	The other method to take over control can be done by activating the priority button for a period of 40 seconds.	The initial sentence is ambiguous, as the reader could understand that the priority is taken only after 40s, which is not correct.	The other method to take over control can be done by activating the priority button for a period of 40 seconds deactivating the other stick and take full control by pressing and keeping pressed his priority takeover pushbutton. For latching the priority condition, the pilot must press the takeover push button for more than 40 s. This allows the pilot to release his takeover push button without losing priority	Accepted
103	Crew Resource Management (2.6), pages 97-98, last paragraph	However, the PIC commanded the SIC to select 'CAPT 3' air data source.	This is not consistent with what is written in chapter 1.11.3 page 41 and chapter 1.11.4 page 45. Moreover, the BEA understands something similar to: "captain three" but is not able to clearly understand the meaning of this statement.	The BEA suggests harmonizing the factual information (chapters 1.11.3 and 1.11.4) regarding this CVR extract, and then analyzing it in this chapter (2.6).	Proposal rejected
104	The Line Maintenance (2.7.1), pages 98-99	Complete chapter.	A paragraph is missing in this chapter to explain why the correct maintenance tasks to solve the repetitive RTL problem were not done (2.7.1).	The BEA suggests adding a paragraph describing the correct maintenance tasks that should have been done accordingly to the AMM and TSM in order to solve the repetitive RTL problem. Section to add:	Accepted

Comment Reference	Reference chapter, page, paragraph	Commented extract	Reason for proposed change	Proposed amendment	Remarks
			Without such a paragraph, the reader could understand that the maintenance was done correctly after the RTLU problem, which is not the case.	"On the December 25th it appears that the RTLU issue occurs 2 times in a short period of time. Using the TSM and PFR data, the maintenance procedure to be used is procedure 22-61-00-810-803-A. This procedure states that if the RTLU fault continues, it is required to change the RTLU. This was not done at the second issue when the Aircraft come back to the Gate."	
105	Findings page 101 (3.1),	9. At 2316:27 UTC, the fifth Master Caution illuminated which was triggered by FAC 1 FAULT followed by FDR signature of erratic fluctuation (...). Twelve seconds later, the FAC 1 parameter back to ON and all fluctuating parameters stopped.	The fifth Master Caution occurred at 2316:29 UTC. Moreover, ten seconds later, at 2316:39 UTC (as indicated in chapter 1.11.1 page 33), it is the FAC 1 Fail parameter that is set to 0, after the FAC 1 C/Bs being pushed.	9. At 2316:29 UTC, FAC 1 was de-energized leading to the ECAM FAC 1 FAULT message associated with the fifth Master Caution, and concomitant with the FDR signature of parameters unavailability of components controlled (...). Ten seconds later, the FAC 1 parameter was re-energized meaning that the FAC1 28VDC CB was reengaged. However because the FAC1 pushbutton on overhead panel was not put to OFF then ON, the FAC1 functions remained unavailable and all parameters alternations stopped.	Accepted with rewording
106	Findings page 101 (3.1),	10. At 2316:44 UTC, the sixth Master Caution triggered by AUTO FLT FAC 1+2 FAULT (...).	The sixth Master Caution occurred at 2316:46 UTC.	10. At 2316:46 UTC, FAC 2 was also de-energized leading to the ECAM FAC 1+2 FAULT message associated with the sixth Master Caution and concomitant with the FDR signature of parameters unavailability. As a consequence (...).	Accepted with rewording
107	Findings page 101 (3.1),	11. The fault on FACs was associated with an interruption of electrical power.	This finding is ambiguous and the reader could understand that the FAC faults were due to a failure in the aircraft's electrical system. It was demonstrated during the investigation that the electrical interruption of the FACs was likely caused by the FACs 28VAC and 28VDC CBs being pulled. This is well explained in chapter 2.2.	The fault on FACs was associated with an interruption of electrical power which was likely due to the FACs CBs being pulled.	Proposal rejected
108	Findings page 101 (3.1),	12. At 2316:54 UTC the FAC 2 parameter was back to ON and all fluctuating parameters stopped.	It is the FAC 2 Fail parameter that is set back to 0, after the FAC 2 C/Bs being pushed.	12. At 2316:54 UTC the FAC 2 was re-energized meaning that the FAC2 28VDC CB was reengaged. However because the FAC2 pushbutton on overhead panel was not put to OFF then ON, the FAC2 functions remained unavailable and all parameters alternations stopped.	Accepted With Rewording
109	Findings page 102 (3.1),	15. The SIC might have been startled when he realized the unusual attitude of the aircraft, as indicated by the CVR record of self-expression.	The CVR analysis performed at the BEA shows that it is the PIC who said "Oh my God" at that time. The exact reason can't be identified. It can just ne noted.	15. The PIC might have been startled when he realized the unusual attitude of the aircraft, as indicated by the CVR record of self-expression.	Accepted with rewording

Comment Reference	Reference chapter, page, paragraph	Commented extract	Reason for proposed change	Proposed amendment	Remarks
110	Findings (3.1), page 102	16. After the right side-stick activated, the aircraft roll angle reduced to 9° left. This rapid right rolling movement might cause an excessive roll sensation to the right. The SIC may have experienced spatial disorientation and over-corrected by shifting the side stick to the left which caused the aircraft rolled back to the left up to 50°.	Without mentioning that the side-stick was activated by the SIC, the reader could understand that it activated by itself. The aircraft rolled back to 53° to the left.	16. After the SIC applied a right side-stick activated input, the aircraft roll angle reduced to 9° left. This rapid right rolling movement might cause an excessive roll sensation to the right. The SIC may have experienced spatial disorientation and over-corrected by shifting the side stick to the left which caused the aircraft rolled back to the left up to 53°.	Accepted
111	Conclusions Item 18 Page 102	The FDR recorded at 2317:15 UTC the aircraft pitch reached 24° up. The PIC commanded „pull down...pull down“ however the FDR recorded the right side stick backward input increased resulting in the AOA increased up to a maximum of 48° up. The Standard Call Out applicable below 10,000 feet mentioned in SOP, should be „PITCH PITCH“ if the pitch angle reaches 10°. There were no equivalent standard call outs in the operators SOP for flight above 10,000 feet.	There are « equivalent » calls above 10 000 ft to indicate the deviation of flight path due to an abnormal pitch: « speed » and « altitude ». Those calls were available if the PIC wanted to draw the attention of the SIC to the visible consequences of the high pitch.	The FDR recorded at 2317:15 UTC the aircraft pitch reached 24° up. The PIC commanded „pull down...pull down“ however the FDR recorded the right side stick backward input increased resulting in the AOA increased up to a maximum of 48° up. The Standard Call Outs applicable below 10,000 feet mentioned in SOP, should be „PITCH PITCH“ if the pitch angle reaches 10°. There were no equivalent standard call outs in the operators SOP for flight above 10,000 feet. should have been „ALTITUDE“, or „SPEED“ as soon as the respective values exceed 100 ft or 10 kt (or Mach 0.02) as mentioned in the operator's SOPs.	Accepted with rewording
112	Findings (3.1), Item 21 page 102	From 2317:29 UTC the PIC side stick started to become active with nose down pitch commands and then mostly at neutral while the SIC (...).	The FDR parameters show that the first side stick inputs from the PIC are pitch down inputs but then alternatively pitch up and pitch down inputs. The PIC side stick position is not neutral at that time.	21. From 2317:29 UTC the PIC side stick started to become active with nose down pitch commands and then alternatively pitch up and pitch down inputs while the SIC (...).	Accepted
113	Findings (3.1), Item 24 page 102	The last data recorded by the FDR were at 2320:35 UTC with the airspeed of 83 kts, pitch 20° up, AOA 50°, roll 8° to left, with the rate of descent of 8,400 ft/minute at a radio altitude of 187 feet.	Some of these values do not correspond to the last data recorded in the FDR.	24. The last data recorded by the FDR were at 2320:35 UTC with the ISIS airspeed of 132 kts, pitch 20° up, AOA 50°, roll 8° to left, the rate of descent of 8,400 ft/minute at a radio altitude of 118 feet.	Accepted
114	3.1 Findings, §26 Page 103	The recorded FDR parameter fluctuations were similar to those recorded on 25 December 2015 when the aircraft had a RTLU problem on the ground and the CBs were reset.		The recorded FDR parameter fluctuations alternations were similar to those recorded on 25 December 2015 when the aircraft had a RTLU problem on the ground and the CBs were reset.	Accepted
115	3.1 Findings, §27 Page 103	27. The experience of the PIC witnessing problem solving by resetting the FAC CBs on 25 December 2014 might have influenced the PIC to adopt the same procedure when confronted with the same problem.		“27. The experience of the PIC witnessing problem solving workaround by resetting the FAC CBs on 25 December 2014 might have influenced the PIC to adopt the same procedure when confronted	Accepted
116	Conclusions Item 29 Page 103	Observation on the Airbus A320 QRH, in the chapter „Computer Reset“ it is stated that: In flight, as a general rule, the crew	The philosophy of computer resets in training is unambiguous and does not require interpretation. When a	In the absence of information on the QRH training philosophy provided to the crew, the BEA suggests to remove this statement	Proposal rejected

Comment Reference	Reference chapter, page, paragraph	Commented extract	Reason for proposed change	Proposed amendment	Remarks
		must restrict computer resets to those listed in the table. Before taking any action on other computers, the flight crew must consider and fully understand the consequences. This statement was potentially ambiguous to the readers and might be open for multiple interpretations.	CB is not in the list, the crews are taught not to reset them.		
117	Findings page 103 Item 32 (3.1).	(...) and take the correct action prior to the actual stall that occurs at 15° AOA. The aircraft system and the pilot training were intended to prevent AOA reaching 15° to avoid stall.	The value of 15° AOA is not consolidated and cannot be used in the report.	(...) and take the correct action prior to the actual stall that occurs at 15° AOA . The aircraft system and the pilot training were intended to prevent AOA reaching high values to avoid stall.	Accepted
118	Findings page 103 Item 33 (3.1).	33. The pilots were trained and had experience of recover from the approaching stall. The condition of stall at zero pitch had never been trained as the training for stall was always with a high pitch attitude.	During the training, the approach to stall is initiated by a progressive deceleration toward the stall. This will have for effect to increase the AoA and the pitch. Later on, after the aircraft has stalled (still high AoA) and the pitch decreased, the simulators are no longer representative as the aircraft is outside the certified and known flight domain.	The BEA suggests to suppress this finding.	Proposal rejected
119	Conclusions Item 38 Page 104	There is no approved means for flight crews to manage multiple/repeated Master Caution alarms to reduce distraction from the alarms.	The BEA understands that this finding refers to the RUD TRV LIM SYS caution that was repeated 4 times. In that case, the crew could have suppressed the warning with the "CLEAR" button.	The BEA proposes to suppress this finding.	Proposal rejected
120	3.1 Findings, §43 Page 104	On 21 December to 27 December 2014, the MR1 recorded 2 pilot reports on 25 December 2014 and on 27 December 2014 related to RTLU while the FDR recorded at least 9 problems.	Section to add	On 21 December to 27 December 2014, the MR1 recorded 2 pilot reports on 25 December 2014 and on 27 December 2014 related to RTLU while the FDR recorded at least 9 problems. During the investigation, December 25th PFR data interpretation and TSM usage indicates that the applicable procedure requires to use the 22-61-810-803-A maintenance procedure instead of the 22-66-810-819-A procedures. The correct application of the 22-61-810-803-A, as the fault continuation on that day, ask then to replace the RTLU instead of what was done by replacing the FAC 2.	Proposal rejected
121	Page 105 – §3.1 Findings Maintenance Item 54	54. There was no reliable method to identify repetitive defects and analyse their effect on continued flight operations.	The Airbus documentation is clear, and the use of PFR and TSM would have identified the cause of the failure and led to the RTLU removal.	54. There was no reliable method used by the operator to identify repetitive defects and analyse their effect on continued flight operations.	Proposal rejected

Comment Reference	Reference chapter, page, paragraph	Commented extract	Reason for proposed change	Proposed amendment	Remarks
122	3.2 Contributing Factors Page 106	The electrical interruption to the FAC's caused the autopilot to disengage and the flight control logic to change from Normal Law to Alternate Law, the rudder deflecting 2° to the left resulting the aircraft rolling up to 54° angle of bank.		The voluntary electrical interruption to the FAC's caused the autopilot to disengage and the flight control logic to change from Normal Law to Alternate Law, the rudder deflecting 2° to the left resulting the aircraft rolling up to 54° angle of bank.	Proposal rejected
123	Safety Recommendations (5), page 109	5.1 Aircraft Operator The KNKT recommends that Indonesia Air Asia develop standard call outs for flight crews for flight above 10,000 ft.	These call-outs exist. See previous comment.	The BEA proposes to suppress this recommendation	Accepted with rewording
124	Safety Recommendations (5), page 109	5.3 Aircraft Manufacturer The KNKT recommends that Airbus Industrie consider developing a means for flight crews to effectively manage multiple and repetitive Master Caution alarms to reduce distraction.	The BEA understands that this finding refers to the RUD TRV LIM SYS caution that was repeated 4 times. In that case, the crew could have suppressed the warning with the "CLEAR" button	The BEA proposes to suppress this recommendation	Proposal rejected
125	Safety Recommendations (5), page 109	5.4 US Federal Aviation Administration and European Aviation Safety Agency The KNKT supports the previous French BEA recommendation on the provision of angle of attack information to flight crews and now recommends that the US Federal Aviation Administration and the European Aviation Safety Agency prioritise the consideration of providing angle of attack information to flight crews in aircraft used for passenger operations.	The BEA proposes to suppress this recommendation. A new recommendation could be made in the light of the new information added in § 2.5, page 96 (cf. comment n°96) with regard to the answers provided by Airbus and EASA to the BEA recommendation.		Proposal rejected
126	Page 138 §6.9 Stall characteristic of high speed aircraft	The whole 6.9	The aircraft manufacturer is the only one which has the sufficient knowledge to give aerodynamic information on its aircraft. This knowledge comes from flight tests, performed with experimental test crews, on aircraft fitted with specific instrumentation. This knowledge is of course limited by the flight domain that the aircraft manufacturer test crew cannot exceed. Clearly the information given in this paragraph concern a flight domain never explored. Consequently nobody is able to say what could happen outside the known domain. Airbus suggests removing this paragraph to avoid dissemination of incorrect information.	We suggest to suppress this paragraph.	Accepted

Additional paragraphs proposed

BEA

1 - DGCAoversight

As three recommendations are addressed to the Indonesian DGCA, the BEA believes that a paragraph dedicated to the oversight of the operator by the Indonesian civil aviation authority could be useful.

2-Assessment of the crew performance

The BEA proposes a paragraph dedicated to the work done on the crew performance and presented to the KNKT on 6th July 2015.

This paragraph could be inserted as 1.16.4 in the report (see attached document to the mail).

Following the insertion of this paragraph, an update on the § 2.6 in the analysis is necessary.

7 REFERENCES

- Airbus. (2014). *Quick Reference Handbook, AirAsia PK-AXC*. Indonesia AirAsia.
- Airbus. (2014). *Flight Crew Training Manual rev.09*. AirAsia.
- Airbus. (2014). *Flight Crew Operating Manual* . AirAsia.
- Airbus. (2006). *A320 Airplane Flight Manual*. Airbus.
- Dehart, R. L. (2002). *Fundamentals of Aerospace Medicine, 3rd Edition*. Baltimore: Lippincott Williams & Wilkins.
- Director of Flight Operations. (2014). *Company Operations Manual rev.09*. PT. Indonesia AirAsia.
- Director of Flight Operations. (2013). *Operations Training Manual issue 4 Rev 00*. PT. Indonesia AirAsia.
- Director of Flight Operations. (2012). *Standard Operating Procedures issue 02 rev.0*. PT. Indonesia AirAsia.
- Ernsting, J. (2003). *Aviation Medicine, 3rd Edition*.
- FAA. (2008). *Upset Recovery Book Rev. 2. November*,
- Rosay, Jacques. (2011, January). *What is stall? How a pilot should react in front of stall situation*. Safety First, Airbus Safety Magazine.
- Thackray, R., & Touchstone, R. (1970). *Recovery of motor performance following startle. Perceptual motor skills.*. Oklahoma City: Civil Aeromedical Institute, FAA.
- Transportation Safety Board of Canada. (2008). *Aviation Investigation Report A08Q0051, Out-of-Trim Nose Down Condition Leading to an Airplane Upset*. Transportation Safety Board of Canada.